



MEET YOUR NEW OLD RELIABLE™

TEKTON[®]

2010-11 PRODUCT
CATALOG



MICHIGAN
INDUSTRIAL
TOOLS



since 1969

TEKTON®

Everyday, do-it-yourself tools — over 1,500 SKUs. Backed by a lifetime replacement or quality guarantee, TEKTON tools are reliable, superior-quality, affordable tools with an appealing retail presence.

MEET YOUR NEW OLD RELIABLE™





Table of Contents

| | |
|-----------------------|----------|
| Sockets and Ratchets | 2 - 19 |
| Wrenches | 20 - 33 |
| Screwdrivers | 34 - 51 |
| Striking Tools | 52 - 58 |
| Prying Tools | 59 - 60 |
| Pliers and Snips | 61 - 66 |
| Electrical Tools | 67 - 70 |
| Clamps | 71 - 75 |
| Vises | 76 - 77 |
| Plumbing | 78 - 79 |
| Staplers and Riveters | 80 |
| Files | 81 - 83 |
| Punches and Chisels | 84 - 90 |
| Saws | 91 - 96 |
| Knives | 97 - 102 |
| Painting | 103 |

| | |
|------------------------------|-----------|
| Safety Equipment | 104 |
| Measuring Tools | 105 - 109 |
| Drill Bits | 110 - 112 |
| Tap and Die | 113 - 114 |
| Pick-Up and Inspection Tools | 115 - 117 |
| Abrasives and Wire Brushes | 118 - 121 |
| Tool Sets | 122 - 123 |
| Hardware | 124 - 125 |
| Automotive Tools | 126 - 139 |
| Lifting and Pulling | 140 - 141 |
| Towing | 142 - 143 |
| Cargo Securing Products | 144 - 147 |
| Tarps | 148 - 149 |
| Air Tools | 150 - 160 |
| Impact Sockets | 161 - 169 |



40-pc. 1/4" and 3/8" Drive Socket Set (SAE/Metric)

- Drop Forged Carbon Steel Ratchets, Sockets and Extensions
- Durable Chrome Plated Finish Resists Corrosion
- Tapered-End 6-Point Sockets
- Reversible-Drive Ratchet Handle with Lock-On Ball Bearing and Non-Slip Knurled Grip
- 12-pc. 1/4" Dr. 6-Point Sockets (SAE): 5/32, 3/16, 7/32, 1/4, 9/32, 5/16, 11/32, 3/8, 13/32, 7/16, 15/32, 1/2"
- 12-pc. 1/4" Dr. 6-Point Sockets (Metric): 4, 4.5, 5, 5.5, 6, 7, 8, 9, 10, 11, 12, 13mm
- 3-pc. 3/8" Dr. 6-Point Sockets (SAE): 7/16, 1/2, 5/8"
- 3-pc. 3/8" Dr. 6-Point Sockets (Metric): 12, 14, 16mm
- 1-pc. 3/8" Dr. x 8" Reversible Ratchet
- 1-pc. 3/8" Dr. x 3" Extension Bar
- 1-pc. 1/4" Dr. (M) x 3/8" Dr. (F) Adapter
- 1-pc. 1/4" Dr. x 6" Spinner Handle
- 1-pc. 3/8" Dr. x 5/8" 6-Point Spark Plug Socket
- 1-pc. 3/8" Dr. Speed Disc
- 3-pc. 1/4" Dr. 8-Point Sockets: 1/4, 5/16, 3/8"
- 1-pc. Storage Case

| Item | Description | Packaging | Cs | In |
|------|--|-----------|----|----|
| 1005 | 40-pc. 1/4" and 3/8" Drive Socket Set (SAE/Metric) | COLOR BOX | 10 | 1 |



40-pc. 1/4" and 3/8" Drive Socket Set (SAE/Metric)

- Drop Forged Carbon Steel Ratchets, Sockets and Extensions
- Durable Chrome Plated Finish Resists Corrosion
- Tapered-End 6-Point Sockets
- Reversible-Drive Ratchet Handle with Lock-On Ball Bearing and Non-Slip Knurled Grip
- 14-pc. 1/4" Dr. 6-Point Sockets (SAE): 5/32, 3/16, 7/32, 1/4, 9/32, 5/16, 11/32, 3/8, 13/32, 7/16, 15/32, 1/2, 17/32, 9/16"
- 14-pc. 1/4" Dr. 6-Point Sockets (Metric): 4, 4.5, 5, 5.5, 6, 6.5, 7, 7.5, 8, 9, 10, 11, 12, 13 mm
- 3-pc. 1/4" Dr. 8-Point Sockets (SAE): 1/4, 5/16, 3/8"
- 2-pc. 3/8" Dr. 6-Point Sockets (SAE): 5/8, 11/16"
- 2-pc. 3/8" Dr. 6-Point Sockets (Metric): 14, 15 mm
- 1-pc. 3/8" Dr. x 8" Reversible Ratchet Handle
- 1-pc. 3/8" Dr. x 3" Extension Bar
- 1-pc. 1/4" Dr. (M) x 3/8" Dr. (F) Adapter
- 1-pc. 3/8" Dr. Speed Disc
- Complete with Storage Case

| Item | Description | Packaging | Cs | In |
|------|--|-----------|----|----|
| 1012 | 40-pc. 1/4" and 3/8" Drive Socket Set (SAE/Metric) | COLOR BOX | 10 | 1 |

17-pc. 1/4" Drive Socket Sets

- Drop Forged Carbon Steel Ratchets, Sockets and Extensions
- Durable Chrome Plated Finish Resists Corrosion
- Tapered-End 6-Point Sockets
- Reversible-Drive Ratchet Handle with Lock-On Ball Bearing and Non-Slip Knurled Grip

1015

- 1-pc. 5" Rev. Ratchet Handle
- 1-pc. 2" Extension Bar
- 1-pc. 6" Spinner Handle
- 2-pc. 1/4" Dr. 8-Point Sockets (SAE): 1/4, 5/16"
- 11-pc. 1/4" Dr. 6-Point Sockets (SAE): 5/32, 3/16, 7/32, 1/4, 9/32, 5/16, 11/32, 3/8, 13/32, 7/16, 1/2"
- 1-pc. Storage Case

1020

- 1-pc. 5" Rev. Ratchet Handle
- 1-pc. 2" Extension Bar
- 1-pc. 6" Spinner Handle
- 13-pc. 1/4" Dr. 6-Point Sockets (Metric): 4, 4.5, 5, 5.5, 6, 7, 8, 9, 10, 11, 12, 13, 14 mm
- 1-pc. Storage Case

| Item | Description | Packaging | Cs | In |
|------|---------------------------------------|--------------|----|----|
| 1015 | 17-pc. 1/4" Drive Socket Set (SAE) | COLOR SLEEVE | 30 | 30 |
| 1020 | 17-pc. 1/4" Drive Socket Set (Metric) | COLOR SLEEVE | 30 | 10 |





52-pc. 1/4", 3/8", 1/2" Drive Socket Set (SAE/Metric)

- Drop Forged Carbon Steel Ratchets, Sockets and Extensions
- Durable Chrome Plated Finish Resists Corrosion
- Tapered-End 6-Point Sockets
- Reversible-Drive Ratchet Handles with Lock-On Ball Bearing and Non-Slip Knurled Grip
- 1-pc. 1/2" Dr. x 10" Rev. Ratchet Handle
- 1-pc. 3/8" Dr. x 8" Rev. Ratchet Handle
- 1-pc. 3/8" Dr. x 3" Extension Bar
- 1-pc. 1/4" Dr.(M) x 3/8" Dr.(F) Adapter
- 1-pc. 1/4" Dr. x 6" Spinner Handle
- 2-pc. 3/8" and 1/2" Dr. Speed Discs
- 1-pc. 3/8" Dr. x 5/8" Spark Plug Socket
- 12-pc. 1/4" Dr. 6-Point Sockets (SAE): 5/32, 3/16, 7/32, 1/4, 9/32, 5/16, 11/32, 3/8, 13/32, 7/16, 15/32, 1/2"
- 3-pc. 1/4" Dr. 8-Point Sockets (SAE): 1/4, 5/16, 3/8"
- 12-pc. 1/4" Dr. 6-Point Sockets (Metric): 4, 4.5, 5, 5.5, 6, 7, 8, 9, 10, 11, 12, 13mm
- 3-pc. 3/8" Dr. 6-Point Sockets (SAE): 9/16, 11/16, 3/4"
- 3-pc. 3/8" Dr. 6-Point Sockets (Metric): 14, 16, 17mm
- 10-pc. 1/2" Dr. 6-Point Sockets (SAE): 3/8, 13/32, 7/16, 15/32, 1/2, 9/16, 5/8, 11/16, 25/32, 13/16"
- 1-pc. Storage Case

| Item | Description | Packaging | Cs | In |
|------|---|--------------|----|----|
| 1035 | 52-pc. 1/4", 3/8", 1/2" Drive Socket Set (SAE/Metric) | COLOR SLEEVE | 5 | 1 |



25-pc. 1/2" Drive Socket Set (SAE)

- Drop Forged Carbon Steel Ratchets, Sockets and Extensions
- Durable Chrome Plated Finish Resists Corrosion
- Tapered-End 6-Point Sockets
- Reversible-Drive Ratchet Handle and Speed Handle with Lock-On Ball Bearing and Non-Slip Knurled Grip
- 1-pc. 10" Rev. Ratchet Handle
- 1-pc. 5" Extension Bar
- 1-pc. 10" Extension Bar
- 1-pc. 16-1/2" Speed Handle
- 1-pc. Speed Disc
- 1-pc. 5/8" Spark Plug Socket
- 18-pc. 1/2" Dr. 6-Point Sockets (SAE): 3/8, 7/16, 15/32, 1/2, 9/16, 19/32, 5/8, 21/32, 11/16, 23/32, 3/4, 25/32, 13/16, 7/8, 15/16, 1, 1-1/8, 1-1/4"
- 1-pc. Storage Case

| Item | Description | Packaging | Cs | In |
|------|------------------------------------|--------------|----|----|
| 1040 | 25-pc. 1/2" Drive Socket Set (SAE) | COLOR SLEEVE | 5 | 1 |

4-pc. 3/8" Drive Tune-Up Kit

- Drop Forged Steel Construction
- Chrome Plated for Durability
- Rubber Grip Handle For Added Torque
- The Most Popular Tools for Do-It-Yourself Tune-Ups
- Ratchet has Convenient 3-Spoke Reverse Lever and Flexible Head for Hard-to-Reach Spark Plugs
- 1-pc. 3/8" Dr. Flex Head Ratchet
- 1-pc. 3/8" Dr. x 6" Extension Bar
- 1-pc. 3/8" Dr. x 5/8" Spark Plug Socket
- 1-pc. 3/8" Dr. x 13/16" Spark Plug Socket



| Item | Description | Packaging | Cs | In |
|------|------------------------------|-----------------------|----|----|
| 1802 | 4-pc. 3/8" Drive Tune-Up Kit | SEALED BLISTER - HALF | 24 | 24 |

4 Socket Tool Kits

22-pc. 1/4" Drive Pro Socket Sets

- Forged and Hardened Chrome Vanadium Steel
- Corrosion-Resistant Chrome Plated Finish
- Tapered-End 6-Point Sockets
- Notched Sockets Lock on to Ratchets and Extensions with Spring-Loaded Ball Bearing Retainer
- Meets or Exceeds ANSI Specifications



11451

- 1-pc. 1/4" Dr. x 5" Ratchet Handle
- 2-pc. Extension Bars: 2" and 6"
- 1-pc. 6" Spinner Handle
- 1-pc. Universal Joint
- 9-pc. 1/4" Dr. 6-Point Sockets: 3/16, 7/32, 1/4, 9/32, 5/16, 11/32, 3/8, 7/16, 1/2"
- 7-pc. 1/4" Dr. 6-Point Deepwell Sockets: 1/4, 9/32, 5/16, 11/32, 3/8, 7/16, 1/2"
- 1-pc. Storage Case

11501

- 1-pc. 1/4" Dr. x 5" Ratchet Handle
- 2-pc. Extension Bars: 2" and 6"
- 1-pc. 6" Spinner Handle
- 1-pc. Universal Joint
- 9-pc. 1/4" Dr. 6-Point Sockets: 4, 5, 5.5, 6, 7, 8, 9, 10, 11mm
- 7-pc. 1/4" Dr. 6-Point Deepwell Sockets: 5.5, 6, 7, 8, 9, 10, 11mm
- 1-pc. Storage Case

| Item | Description | Packaging | Cs | In |
|-------|---|-----------|----|----|
| 11451 | 22-pc. 1/4" Drive Pro Socket Set (SAE) | COLOR BOX | 10 | 10 |
| 11501 | 22-pc. 1/4" Drive Pro Socket Set (Metric) | COLOR BOX | 10 | 1 |

21-pc. 3/8" Drive Pro Socket Sets

- Forged and Hardened Chrome Vanadium Steel
- Corrosion-Resistant Chrome Plated Finish
- Tapered-End 6-Point Sockets
- Notched Sockets Lock on to Ratchets and Extensions with Spring-Loaded Ball Bearing Retainer
- Meets or Exceeds ANSI Specifications



11551

- 1-pc. 3/8" Dr. x 8" Ratchet Handle
- 2-pc. Extension Bars: 1-3/4" and 3"
- 9-pc. 3/8" Dr. 6-Point Sockets (SAE): 3/8, 7/16, 1/2, 9/16, 5/8, 11/16, 3/4, 13/16, 7/8"
- 8-pc. 3/8" Dr. 6-Point Deepwell Sockets (SAE): 3/8, 7/16, 1/2, 9/16, 5/8, 11/16, 3/4, 13/16"
- 1-pc. Storage Case

11601

- 1-pc. 3/8" Dr. x 8" Ratchet Handle
- 2-pc. Extensions Bars: 1-3/4" and 3"
- 9-pc. 3/8" Dr. 6-Point Sockets: 9, 10, 11, 12, 13, 14, 15, 17, 19mm
- 8-pc. 3/8" Dr. 6-Point Deepwell Sockets: 10, 11, 12, 13, 14, 15, 17, 19mm
- 1-pc. Storage Case

| Item | Description | Packaging | Cs | In |
|-------|---|-----------|----|----|
| 11551 | 21-pc. 3/8" Drive Pro Socket Set (SAE) | COLOR BOX | 10 | 10 |
| 11601 | 21-pc. 3/8" Drive Pro Socket Set (Metric) | COLOR BOX | 10 | 1 |

17-pc. 1/2" Drive Pro Socket Sets

- Forged and Hardened Chrome Vanadium Steel
- Corrosion-Resistant Chrome Plated Finish
- Tapered-End 6-Point Sockets
- Notched Sockets Lock on to Ratchets and Extensions with Spring-Loaded Ball Bearing Retainer
- Meets or Exceeds ANSI Specifications



11651

- 1-pc. 1/2" Dr. x 10" Ratchet Handle
- 1-pc. 5" Extension Bar
- 1-pc. 14" Flex Breaker Bar
- 13-pc. 1/2" Dr. 6-Point Sockets: 7/16, 1/2, 9/16, 5/8, 11/16, 3/4, 13/16, 7/8, 15/16, 1, 1-1/16, 1-1/8, 1-1/4"
- 1-pc. Storage Case

11701

- 1-pc. 1/2" Dr. x 10" Ratchet Handle
- 1-pc. 5" Extension Bar
- 1-pc. 14" Flex Breaker Bar
- 13-pc. 1/2" Dr. 6-Point Sockets (Metric): 10, 11, 12, 13, 14, 17, 19, 20, 21, 22, 23, 24, 27mm
- 1-pc. Storage Case

| Item | Description | Packaging | Cs | In |
|-------|---|-----------|----|----|
| 11651 | 17-pc. 1/2" Drive Pro Socket Set (SAE) | COLOR BOX | 6 | 6 |
| 11701 | 17-pc. 1/2" Drive Pro Socket Set (Metric) | COLOR BOX | 6 | 1 |

60-pc. 1/4", 3/8", and 1/2" Drive Pro Socket Sets

- Forged and Hardened Chrome Vanadium Steel
- Corrosion-Resistant Chrome Plated Finish
- Tapered-End 6-Point Sockets
- Notched Sockets Lock on to Ratchets and Extensions with Spring-Loaded Ball Bearing Retainer
- Meets or Exceeds ANSI Specifications

11761

- 1-pc. 1/4" Dr. x 5-1/2" Ratchet Handle
- 1-pc. 3/8" Dr. x 8" Ratchet Handle
- 1-pc. 1/2" Dr. x 10" Ratchet Handle
- 3-pc. Speed Discs: 1/4" Dr., 3/8" Dr., 1/2" Dr.
- 1-pc. 1/2" Dr. x 17" Flex Breaker Bar
- 2-pc. 1/4" Dr. Extension Bars: 2" and 4"
- 2-pc. 3/8" Dr. Extension Bars: 1-3/4" and 3"
- 1-pc. 1/2" Dr. Extension Bar: 5"
- 1-pc. 1/4" Dr. x 6" Spinner Handle
- 1-pc. 1/4" Dr. Universal Joint
- 9-pc. 1/4" Dr. 6-Point Sockets (SAE): 3/16, 7/32, 1/4, 9/32, 5/16, 11/32, 3/8, 7/16, 1/2"
- 7-pc. 1/4" Dr. Deepwell 6-Point Sockets (SAE): 1/4, 9/32, 5/16, 11/32, 3/8, 7/16, 1/2"
- 9-pc. 3/8" Dr. 6-Point Sockets (SAE): 3/8, 7/16, 1/2, 9/16, 5/8, 11/16, 3/4, 13/16, 7/8"
- 8-pc. 3/8" Dr. Deepwell 6-Point Sockets (SAE): 3/8, 7/16, 1/2, 9/16, 5/8, 11/16, 3/4, 13/16"
- 13-pc. 1/2" Dr. 6-Point Sockets (SAE): 7/16, 1/2, 9/16, 5/8, 11/16, 3/4, 13/16, 7/8, 15/16, 1", 1-1/16, 1-1/8, 1-1/4"
- 1-pc. Storage Case

11811

- 1-pc. 1/4" Dr. x 5-1/2" Ratchet Handle
- 1-pc. 3/8" Dr. x 8" Ratchet Handle
- 1-pc. 1/2" Dr. x 10" Ratchet Handle
- 3-pc. Speed Discs: 1/4" Dr., 3/8" Dr., 1/2" Dr.
- 1-pc. 1/2" Dr. x 17" Flex Breaker Bar
- 2-pc. 1/4" Dr. Extension Bars: 2" and 4"
- 2-pc. 3/8" Dr. Extension Bars: 1-3/4" and 3"
- 1-pc. 1/2" Dr. Extension Bar: 5"
- 1-pc. 1/4" Dr. x 6" Spinner Handle
- 1-pc. 1/4" Dr. Universal Joint
- 9-pc. 1/4" Dr. 6-Point Sockets (Metric): 4, 5, 5.5, 6, 7, 8, 9, 10, 11mm
- 7-pc. 1/4" Dr. Deepwell 6-Point Sockets (Metric): 5.5, 6, 7, 8, 9, 10, 11mm
- 9-pc. 3/8" Dr. 6-Point Sockets (Metric): 9, 10, 11, 12, 13, 14, 15, 17, 19mm
- 8-pc. 3/8" Dr. Deepwell 6-Point Sockets (Metric): 10, 11, 12, 13, 14, 15, 17, 19mm
- 13-pc. 1/2" Dr. 6-Point Sockets (Metric): 10, 11, 12, 13, 14, 17, 19, 20, 21, 22, 23, 24, 27mm
- 1-pc. Storage Case



| Item | Description | Packaging | Cs | In |
|-------|---|-----------|----|----|
| 11761 | 60-pc. 1/4", 3/8", 1/2" Drive Pro Socket Set (SAE) | COLOR BOX | 3 | 3 |
| 11811 | 60-pc. 1/4", 3/8", 1/2" Drive Pro Socket Set (Metric) | COLOR BOX | 3 | 1 |

11-pc. 3/8" Drive Pro Socket Sets

- Drop Forged, Heat Treated Chrome Vanadium Steel
- Corrosion-Resistant, Chrome Plated Finish
- Tapered-End, 6-Point Sockets with Notched, Lock-On Drive End
- Knurled-Grip Ratchet Handle with Lock-On Drive Tang
- Meets or Exceeds ANSI Specifications

1816

- 1-pc. 8" Ratchet Handle
- 10-pc. 3/8" Dr. 6-Point Sockets (SAE): 3/8, 7/16, 15/32, 1/2, 9/16, 5/8, 11/16, 3/4, 13/16, 7/8"

1817

- 1-pc. 8" Ratchet Handle
- 10-pc. 3/8" Dr. 6-Point Sockets (Metric): 10, 11, 12, 13, 14, 15, 16, 17, 18, 19mm

| Item | Description | Packaging | Cs | In |
|------|---|-------------------------|----|----|
| 1816 | 11-pc. 3/8" Drive Pro Socket Set (SAE) | PLASTIC HANG RACK/LABEL | 24 | 24 |
| 1817 | 11-pc. 3/8" Drive Pro Socket Set (Metric) | PLASTIC HANG RACK/LABEL | 24 | 6 |



11-pc. 1/2" Drive Pro Socket Sets

- Drop Forged, Heat Treated Chrome Vanadium Steel
- Corrosion-Resistant, Chrome Plated Finish
- Tapered-End, 6-Point Sockets with Notched, Lock-On Drive End
- Knurled-Grip Ratchet Handle with Lock-On Drive Tang
- Meets or Exceeds ANSI Specifications

1818

- 1-pc. 10" Ratchet Handle
- 10-pc. 1/2" Dr. 6-Point Sockets (SAE): 3/8, 7/16, 15/32, 1/2, 9/16, 5/8, 11/16, 3/4, 13/16, 7/8"

1819

- 1-pc. 10" Ratchet Handle
- 10-pc. 1/2" Dr. 6-Point Sockets (Metric): 10, 11, 12, 13, 14, 15, 16, 17, 18, 19mm

| Item | Description | Packaging | Cs | In |
|------|---|-------------------------|----|----|
| 1818 | 11-pc. 1/2" Drive Pro Socket Set (SAE) | PLASTIC HANG RACK/LABEL | 24 | 24 |
| 1819 | 11-pc. 1/2" Drive Pro Socket Set (Metric) | PLASTIC HANG RACK/LABEL | 24 | 6 |





21-pc. 3/4" Drive Jumbo Socket Sets

- Drop Forged, Heat-Treated Carbon Steel Construction
- Corrosion-Resistant Chrome Plated Finish
- Tapered-End, 6-Point Sockets with Notched Drive End Lock onto Ratchets and Extensions
- Ratchet Handle and Breaker Bar with Socket-Retaining Drive Tang and Non-Slip, Knurled Handle Grip

1100

- 1-pc. 3/4" Drive 19-1/2" Ratchet Handle
- 1-pc. 3/4" Drive 18" Flex Breaker Bar
- 2-pc. 3/4" Drive Extension Bars: 4", 8"
- 17-pc. 3/4" Drive 6-Point Sockets (Metric): 19, 22, 24, 26, 27, 28, 30, 32, 34, 36, 38, 41, 42, 45, 46, 48, 50mm
- Complete with Carry Case

1115

- 1-pc. 3/4" Drive 19-1/2" Ratchet Handle
- 1-pc. 3/4" Drive 18" Flex Breaker Bar
- 2-pc. 3/4" Drive Extension Bars: 4", 8"
- 16-pc. 3/4" Drive 6-Point Sockets (SAE): 7/8", 15/16", 1", 1-1/16", 1-1/8", 1-3/16", 1-1/4", 1-5/16", 1-3/8", 1-7/16", 1-1/2", 1-5/8", 1-3/4", 1-13/16", 1-7/8", 2"
- 1-pc. Carry Case

| Item | Description | Packaging | Cs | In |
|------|---|-----------|----|----|
| 1100 | 21-pc. 3/4" Drive Jumbo Socket Set (Metric) | COLOR BOX | 2 | 2 |
| 1115 | 21-pc. 3/4" Drive Jumbo Socket Set (SAE) | COLOR BOX | 2 | 1 |



21-pc. 1" Drive Jumbo Socket Set (SAE)

- Drop Forged, Heat Treated Carbon Steel Construction
- Corrosion-Resistant Chrome Plated Finish
- Tapered-End, 12-Point Sockets with Lock-On Notched Drive End
- 43-Tooth, Knurled-Grip Ratchet Handle with Lock-On Drive Tang

- 1-pc. 1" Drive 25" Ratchet Handle
- 1-pc. 1" Drive 22" Sliding T-Head Breaker Bar
- 1-pc. 1" Drive 8" Extension Bar
- 1-pc. 1" Drive 18" Extension Bar
- 16-pc. 1" Drive 12-Point Sockets (SAE): 1-5/8", 1-11/16", 1-3/4", 1-13/16", 1-7/8", 2", 2-1/8", 2-3/16", 2-1/4", 2-3/8", 2-1/2", 2-5/8", 2-3/4", 2-15/16", 3", 3-1/8"
- 1-pc. Steel Carry Case

| Item | Description | Packaging | Cs | In |
|------|--|------------------|----|----|
| 1120 | 21-pc. 1" Drive Jumbo Socket Set (SAE) | PLAIN BOX/NO UPC | 1 | 1 |



26-pc. 3/4" and 1" Drive Jumbo Socket Set (SAE)

- Drop Forged, Heat Treated Manganese Ratchets, Sockets and Extensions
- Durable Sandblasted Finish
- Tapered 12-Point Socket Ends for Easy Access to Nuts and Bolts
- Notches in Sockets Lock onto Ratchets and Extensions
- Knurled Pattern on Ratchet Handles Provides Excellent Gripping Power
- Spring Loaded Ball Bearing Locks Sockets Securely in Position
- Features a Heavy Duty Metal Carry Case for Organized Storage of All Components

- 1-pc. 3/4" Dr. Ratchet Head
- 1-pc. 3/4" Dr. x 21" Breaker Bar Handle
- 1-pc. 3/4" Dr. x 21" Extension Bar
- 1-pc. 3/4" Dr. x 8" Extension Bar
- 1-pc. 3/4" Dr. (F) x 1" Dr. (M) Adapter
- 1-pc. Sliding T-Bar Adapter
- 17-pc. 3/4" Dr. 12-Point Sockets (SAE): 15/16, 1, 1-1/16, 1-1/8, 1-1/4, 1-3/16, 1-5/16, 1-3/8, 1-7/16, 1-1/2, 1-5/8, 1-11/16, 1-3/4, 1-13/16, 1-7/8, 2"
- 3-pc. 1" Dr. 12-Point Sockets (SAE): 2-1/4, 2-1/2, 2-3/4"
- Complete with Steel Carry Case

| Item | Description | Packaging | Cs | In |
|------|---|---------------|----|----|
| 1118 | 26-pc. 3/4" and 1" Drive Jumbo Socket Set (SAE) | PLAIN BOX/UPC | 1 | 1 |



9-pc. 3/4" Drive Jumbo Socket Set (SAE)

- Drop Forged, Heat-Treated Carbon Steel Construction
- Corrosion-Resistant Chrome Plated Finish
- Tapered-End, 12-Point Sockets
- Notched End Locks onto Drive Tang
- 8-pc. 3/4" Drive Sockets - 12-point (SAE): 2-1/16", 2-1/8", 2-3/16", 2-1/4", 2-5/16", 2-3/8", 2-7/16", 2-1/2"
- 1-pc. Carry Case

| Item | Description | Packaging | Cs | In |
|------|---|-----------|----|----|
| 1110 | 9-pc. 3/4" Drive Jumbo Socket Set (SAE) | COLOR BOX | 2 | 1 |



11-pc. 1/4" and 3/8" Drive Star Socket Set

- Drop Forged, Heat Treated Chrome Vanadium Steel
- Corrosion-Resistant, Chrome-Plated Finish
- Notched Drive Locks onto Ratchet or Extension
- Tapered-End Star Drive Sockets
- 5-pc. 1/4" Dr. Star Sockets: E4, E5, E6, E7, E8
- 5-pc. 3/8" Dr. Star Sockets: E10, E12, E14, E16, E18
- 1-pc. Storage Rail

| Item | Description | Packaging | Cs | In |
|------|--|--------------------|----|----|
| 1355 | 11-pc. 1/4" and 3/8" Drive Star Socket Set | SLIDE BLISTER CARD | 48 | 6 |

9-pc. 1/4" Drive Socket Sets

- Drop Forged Carbon Steel Construction
- Corrosion-Resistant, Chrome Plated Finish
- Tapered-End 6-Point Sockets

1804

- 8-pc. 1/4" Dr. 6-Point Sockets (SAE): 3/16, 1/4, 9/32, 5/16, 11/32, 3/8, 7/16, 1/2"
- 1-pc. Storage Rail

| Item | Description | Packaging | Cs | In |
|------|--------------------------------------|--------------------|----|----|
| 1804 | 9-pc. 1/4" Drive Socket Set (SAE) | SLIDE BLISTER CARD | 48 | 48 |
| 1805 | 9-pc. 1/4" Drive Socket Set (Metric) | SLIDE BLISTER CARD | 48 | 12 |

1805

- 8-pc. 1/4" Dr. 6-Point Sockets (Metric): 6, 7, 8, 9, 10, 11, 12, 13mm
- 1-pc. Storage Rail



9-pc. 3/8" Drive Socket Sets

- Drop Forged, Heat Treated Chrome Vanadium Steel
- Corrosion-Resistant, Chrome-Plated Finish
- Notched Drive Locks onto Ratchet or Extension
- Tapered-End 6-Point Sockets
- Meets or Exceeds ANSI Specifications

1806

- 8-pc. 3/8" Dr. 6-Point Sockets (SAE): 3/8, 7/16, 1/2, 9/16, 5/8, 11/16, 3/4, and 13/16"
- 1-pc. Storage Rail

| Item | Description | Packaging | Cs | In |
|------|--------------------------------------|--------------------|----|----|
| 1806 | 9-pc. 3/8" Drive Socket Set (SAE) | SLIDE BLISTER CARD | 48 | 48 |
| 1807 | 9-pc. 3/8" Drive Socket Set (Metric) | SLIDE BLISTER CARD | 48 | 6 |

1807

- 8-pc. 3/8" Dr. 6-Point Sockets (Metric): 10, 11, 12, 13, 14, 15, 17, 19mm
- 1-pc. Storage Rail



13-pc. 3/8" Drive Socket Sets

- Drop Forged Carbon Steel Construction
- Corrosion-Resistant, Chrome Plated Finish
- Tapered-End 6-Point Sockets

1814

- 12-pc. 3/8" Dr. 6-Point Sockets (SAE): 5/16, 11/32, 3/8, 13/32, 7/16, 15/32, 1/2, 9/16, 19/32, 5/8, 11/16, 3/4"
- 1-pc. Storage Rail

| Item | Description | Packaging | Cs | In |
|------|---------------------------------------|--------------------|----|----|
| 1814 | 13-pc. 3/8" Drive Socket Set (SAE) | SLIDE BLISTER CARD | 36 | 36 |
| 1815 | 13-pc. 3/8" Drive Socket Set (Metric) | SLIDE BLISTER CARD | 36 | 6 |

1815

- 12-pc. 3/8" Dr. 6-Point Sockets (Metric): 8, 9, 10, 11, 12, 13, 14, 15, 16, 17, 18, 19mm
- 1-pc. Storage Rail



8 Socket Sets



9-pc. 1/4" Drive Deepwell Socket Sets

- Drop Forged Carbon Steel Construction
- Corrosion-Resistant Chrome Plated Finish
- Notched Drive Locks onto Ratchet or Extension
- Tapered-End 6-Point Sockets

1215

- 8-pc. 1/4" Dr. Deepwell 6-Point Sockets (SAE): 3/16, 7/32, 1/4, 9/32, 5/16, 11/32, 3/8, 7/16"
- 1-pc. Storage Rack

1220

- 8-pc. 1/4" Dr. Deepwell 6-Point Sockets (Metric): 5.5, 6, 7, 8, 9, 10, 11, 12mm
- 1-pc. Storage Rack

| Item | Description | Packaging | Cs | In |
|------|---|-------------------------|----|----|
| 1215 | 9-pc. 1/4" Drive Deepwell Socket Set (SAE) | PLASTIC HANG RACK/LABEL | 40 | 10 |
| 1220 | 9-pc. 1/4" Drive Deepwell Socket Set (Metric) | PLASTIC HANG RACK/LABEL | 40 | 10 |



9-pc. 3/8" Drive Deepwell Socket Sets

- Drop Forged Carbon Steel Construction
- Corrosion-Resistant Chrome Plated Finish
- Notched Drive Locks onto Ratchet or Extension
- Tapered-End 6-Point Sockets

1225

- 8-pc. 3/8" Dr. Deepwell 6-Point Sockets (SAE): 3/8, 7/16, 1/2, 9/16, 5/8, 11/16, 3/4, 13/16"
- 1-pc. Storage Rack

1230

- 8-pc. 3/8" Dr. Deepwell 6-Point Sockets (Metric): 10, 11, 12, 13, 14, 15, 17, 19mm
- 1-pc. Storage Rack

| Item | Description | Packaging | Cs | In |
|------|---|-------------------------|----|----|
| 1225 | 9-pc. 3/8" Drive Deepwell Socket Set (SAE) | PLASTIC HANG RACK/LABEL | 20 | 10 |
| 1230 | 9-pc. 3/8" Drive Deepwell Socket Set (Metric) | PLASTIC HANG RACK/LABEL | 20 | 10 |



9-pc. 3/8" Drive Deepwell Socket Sets

- Drop Forged, Heat Treated Chrome Vanadium Steel
- Corrosion-Resistant Chrome Plated Finish
- Notched Drive Locks onto Ratchet or Extension
- Tapered-End 6-Point Sockets

1235

- 8-pc. 3/8" Dr. Deepwell 6-Point Sockets (SAE): 3/8, 7/16, 1/2, 9/16, 5/8, 11/16, 3/4, 13/16"
- 1-pc. Storage Rack

1240

- 8-pc. 3/8" Dr. Deepwell 6-Point Sockets (Metric): 10, 11, 12, 13, 14, 15, 17, 19mm
- 1-pc. Storage Rack

| Item | Description | Packaging | Cs | In |
|------|---|-------------------------|----|----|
| 1235 | 9-pc. 3/8" Drive Deepwell Socket Set (SAE) | PLASTIC HANG RACK/LABEL | 20 | 10 |
| 1240 | 9-pc. 3/8" Drive Deepwell Socket Set (Metric) | PLASTIC HANG RACK/LABEL | 20 | 10 |



9-pc. 1/2" Drive Deepwell Socket Sets

- Drop Forged, Heat Treated Chrome Vanadium Steel
- Corrosion-Resistant Chrome Plated Finish
- Notched Drive Locks onto Ratchet or Extension
- Tapered-End 6-Point Sockets

1255

- 8-pc. 1/2" Dr. Deepwell 6-Point Sockets (SAE): 1/2, 9/16, 5/8, 11/16, 3/4, 13/16, 7/8, 15/16"
- 1-pc. Storage Rack

1260

- 8-pc. 1/2" Dr. Deepwell 6-Point Sockets (Metric): 13, 14, 15, 17, 18, 19, 21, 22mm
- 1-pc. Storage Rack

| Item | Description | Packaging | Cs | In |
|------|---|-------------------------|----|----|
| 1255 | 9-pc. 1/2" Drive Deepwell Socket Set (SAE) | PLASTIC HANG RACK/LABEL | 16 | 8 |
| 1260 | 9-pc. 1/2" Drive Deepwell Socket Set (Metric) | PLASTIC HANG RACK/LABEL | 16 | 8 |

9-pc. 1/2" Drive Deepwell Socket Sets

- Drop Forged Carbon Steel Construction
- Corrosion-Resistant Chrome Plated Finish
- Notched Drive Locks onto Ratchet or Extension
- Tapered-End 6-Point Sockets

1245

- 8-pc. 1/2" Dr. Deepwell 6-Point Sockets (SAE): 1/2, 9/16, 5/8, 11/16, 3/4, 13/16, 7/8, 15/16"
- 1-pc. Storage Rack

1250

- 8-pc. 1/2" Dr. Deepwell 6-Point Sockets (Metric): 13, 14, 15, 17, 18, 19, 21, 22mm
- 1-pc. Storage Rack

| Item | Description | Packaging | Cs | In |
|------|---|-------------------------|----|----|
| 1245 | 9-pc. 1/2" Drive Deepwell Socket Set (SAE) | PLASTIC HANG RACK/LABEL | 16 | 16 |
| 1250 | 9-pc. 1/2" Drive Deepwell Socket Set (Metric) | PLASTIC HANG RACK/LABEL | 16 | 8 |



9-pc. 1/4" Drive Deepwell Socket Sets

- Drop Forged Carbon Steel Construction
- Corrosion-Resistant Chrome Plated Finish
- Notched Drive End Locks onto Ratchet or Extension
- Tapered-End 6-Point Sockets

1216

- 8-pc. 1/4" Dr. Deepwell 6-Point Sockets (SAE): 3/16, 7/32, 1/4, 9/32, 5/16, 11/32, 3/8, 7/16"
- 1-pc. 8-Clip Socket Holder

1221

- 8-pc. 1/4" Dr. Deepwell 6-Point Sockets (Metric): 5.5, 6, 7, 8, 9, 10, 11, 12mm
- 1-pc. 8-Clip Socket Holder

| Item | Description | Packaging | Cs | In |
|------|---|--------------------|----|----|
| 1216 | 9-pc. 1/4" Drive Deepwell Socket Set (SAE) | SLIDE BLISTER CARD | 36 | 36 |
| 1221 | 9-pc. 1/4" Drive Deepwell Socket Set (Metric) | SLIDE BLISTER CARD | 36 | 6 |



9-pc. 3/8" Drive Deepwell Socket Sets

- Drop Forged Carbon Steel Construction
- Corrosion-Resistant Chrome Plated Finish
- Notched Drive End Locks onto Ratchet or Extension
- Tapered-End 6-Point Sockets

1226

- 8-pc. 3/8" Dr. Deepwell 6-Point Sockets (SAE): 3/8, 7/16, 1/2, 9/16, 5/8, 11/16, 3/4, 13/16"
- 1-pc. 8-Clip Socket Holder

1231

- 8-pc. 3/8" Dr. Deepwell 6-Point Sockets (Metric): 10, 11, 12, 13, 14, 15, 17, 19mm
- 1-pc. 8-Clip Socket Holder

| Item | Description | Packaging | Cs | In |
|------|---|--------------------|----|----|
| 1226 | 9-pc. 3/8" Drive Deepwell Socket Set (SAE) | SLIDE BLISTER CARD | 24 | 24 |
| 1231 | 9-pc. 3/8" Drive Deepwell Socket Set (Metric) | SLIDE BLISTER CARD | 24 | 6 |



9-pc. 1/2" Drive Deepwell Socket Sets

- Drop Forged Carbon Steel Construction
- Corrosion-Resistant Chrome Plated Finish
- Notched Drive End Locks onto Ratchet or Extension
- Tapered-End 6-Point Sockets

1246

- 8-pc. 1/2" Dr. Deepwell 6-Point Sockets (SAE): 1/2, 9/16, 5/8, 11/16, 3/4, 13/16, 7/8, 15/16"
- 1-pc. 8-Clip Socket Holder

1251

- 8-pc. 1/2" Dr. Deepwell 6-Point Sockets (Metric): 13, 14, 15, 17, 18, 19, 21, 22mm
- 1-pc. 8-Clip Socket Holder

| Item | Description | Packaging | Cs | In |
|------|---|--------------------|----|----|
| 1246 | 9-pc. 1/2" Drive Deepwell Socket Set (SAE) | SLIDE BLISTER CARD | 16 | 16 |
| 1251 | 9-pc. 1/2" Drive Deepwell Socket Set (Metric) | SLIDE BLISTER CARD | 16 | 8 |



10 Individual Sockets

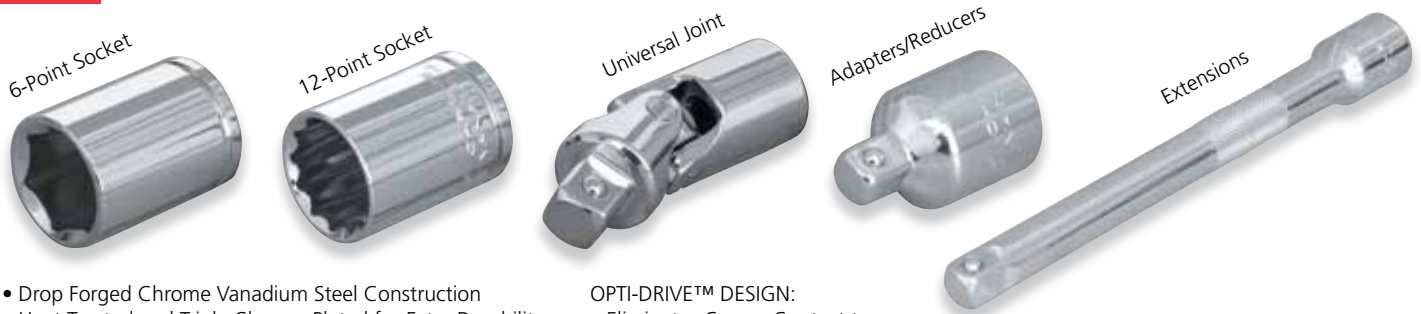

- Drop Forged Chrome Vanadium Steel Construction
- Heat Treated and Triple Chrome Plated for Extra Durability
- Notches in Sockets Lock onto Ratchets or Extensions

- OPTI-DRIVE™ DESIGN:
- Eliminates Corner Contact to Prevent Fastener from Rounding Off

1/4" Drive Sockets and Accessories

| SAE SIZES | | METRIC SIZES | |
|------------------------|-------------------------------------|------------------------|--------------------------------------|
| SHALLOW 6-POINT | | SHALLOW 6-POINT | |
| 14100 | 1/4" DR X 3/16" SHALLOW SKT (6-PT) | 14109 | 1/4" DR X 4MM SHALLOW SKT (6-PT) |
| 14101 | 1/4" DR X 7/32" SHALLOW SKT (6-PT) | 14110 | 1/4" DR X 5MM SHALLOW SKT (6-PT) |
| 14102 | 1/4" DR X 1/4" SHALLOW SKT (6-PT) | 14111 | 1/4" DR X 6MM SHALLOW SKT (6-PT) |
| 14103 | 1/4" DR X 9/32" SHALLOW SKT (6-PT) | 14112 | 1/4" DR X 7MM SHALLOW SKT (6-PT) |
| 14104 | 1/4" DR X 5/16" SHALLOW SKT (6-PT) | 14113 | 1/4" DR X 8MM SHALLOW SKT (6-PT) |
| 14105 | 1/4" DR X 11/32" SHALLOW SKT (6-PT) | 14114 | 1/4" DR X 9MM SHALLOW SKT (6-PT) |
| 14106 | 1/4" DR X 3/8" SHALLOW SKT (6-PT) | 14115 | 1/4" DR X 10MM SHALLOW SKT (6-PT) |
| 14107 | 1/4" DR X 7/16" SHALLOW SKT (6-PT) | 14116 | 1/4" DR X 11MM SHALLOW SKT (6-PT) |
| 14108 | 1/4" DR X 1/2" SHALLOW SKT (6-PT) | 14117 | 1/4" DR X 12MM SHALLOW SKT (6-PT) |
| DEEP 6-POINT | | DEEP 6-POINT | |
| 14118 | 1/4" DR X 3/16" DEEP SOCKET (6-PT) | 14127 | 1/4" DR UNIVERSAL JOINT |
| 14119 | 1/4" DR X 7/32" DEEP SOCKET (6-PT) | 14128 | 1/4" DR X 3" EXTENSION BAR |
| 14120 | 1/4" DR X 1/4" DEEP SOCKET (6-PT) | 14129 | 1/4" DR X 6" EXTENSION BAR |
| 14121 | 1/4" DR X 9/32" DEEP SOCKET (6-PT) | 14269 | 1/4" DR (F) X 3/8" DRIVE (M) ADAPTOR |
| 14122 | 1/4" DR X 5/16" DEEP SOCKET (6-PT) | | |
| 14123 | 1/4" DR X 11/32" DEEP SOCKET (6PT) | | |
| 14124 | 1/4" DR X 3/8" DEEP SOCKET (6-PT) | | |
| 14125 | 1/4" DR X 7/16" DEEP SOCKET (6-PT) | | |
| 14126 | 1/4" DR X 1/2" DEEP SOCKET (6-PT) | | |

SOCKET ACCESSORIES

- 14127 1/4" DR UNIVERSAL JOINT
- 14128 1/4" DR X 3" EXTENSION BAR
- 14129 1/4" DR X 6" EXTENSION BAR
- 14269 1/4" DR (F) X 3/8" DRIVE (M) ADAPTOR

3/8" Drive Sockets and Accessories

| SAE SIZES | SHALLOW 6-POINT | SHALLOW 12-POINT | DEEP 6-POINT | |
|--------------|-------------------------------------|-----------------------------------|--------------------------------------|--------------------------------------|
| | 14130 | 3/8" DR X 3/8" SHALLOW SKT (6-PT) | 14154 | 3/8" DR X 3/8" SHALLOW SKT (12-PT) |
| 14131 | 3/8" DR X 7/16" SHALLOW SKT (6-PT) | 14155 | 3/8" DR X 7/16" SHALLOW SKT (12-PT) | |
| 14132 | 3/8" DR X 1/2" SHALLOW SKT (6-PT) | 14156 | 3/8" DR X 1/2" SHALLOW SKT (12-PT) | |
| 14133 | 3/8" DR X 9/16" SHALLOW SKT (6-PT) | 14157 | 3/8" DR X 9/16" SHALLOW SKT (12-PT) | |
| 14134 | 3/8" DR X 5/8" SHALLOW SKT (6-PT) | 14158 | 3/8" DR X 5/8" SHALLOW SKT (12-PT) | |
| 14135 | 3/8" DR X 11/16" SHALLOW SKT (6-PT) | 14159 | 3/8" DR X 11/16" SHALLOW SKT (12-PT) | |
| 14136 | 3/8" DR X 3/4" SHALLOW SKT (6-PT) | 14160 | 3/8" DR X 3/4" SHALLOW SKT (12-PT) | |
| 14137 | 3/8" DR X 13/16" SHALLOW SKT (6-PT) | 14161 | 3/8" DR X 13/16" SHALLOW SKT (12-PT) | |
| 14138 | 3/8" DR X 7/8" SHALLOW SKT (6-PT) | 14162 | 3/8" DR X 7/8" SHALLOW SKT (12-PT) | |
| | | | 14177 | 3/8" DR X 5/16" DEEP SOCKET (6-PT) |
| | | | 14178 | 3/8" DR X 3/8" DEEP SOCKET (6-PT) |
| | | | 14179 | 3/8" DR X 7/16" DEEP SOCKET (6-PT) |
| | | | 14180 | 3/8" DR X 1/2" DEEP SOCKET (6-PT) |
| | | | 14181 | 3/8" DR X 9/16" DEEP SOCKET (6-PT) |
| | | | 14182 | 3/8" DR X 5/8" DEEP SOCKET (6-PT) |
| | | | 14183 | 3/8" DR X 11/16" DEEP SOCKET (6-PT) |
| | | | 14184 | 3/8" DR X 3/4" DEEP SOCKET (6-PT) |
| | | | 14185 | 3/8" DR X 13/16" DEEP SOCKET (6-PT) |
| | | | 14186 | 3/8" DR X 7/8" DEEP SOCKET (6-PT) |
| | | | 14187 | 3/8" DR X 15/16" DEEP SOCKET (6-PT) |
| METRIC SIZES | SHALLOW 6-POINT | SHALLOW 12-POINT | DEEP 6-POINT | |
| | 14139 | 3/8" DR X 7MM SHALLOW SKT (6-PT) | 14163 | 3/8" DR X 7MM SHALLOW SKT (12-PT) |
| 14140 | 3/8" DR X 8MM SHALLOW SKT (6-PT) | 14164 | 3/8" DR X 8MM SHALLOW SKT (12-PT) | |
| 14141 | 3/8" DR X 9MM SHALLOW SKT (6-PT) | 14165 | 3/8" DR X 9MM SHALLOW SKT (12-PT) | |
| 14142 | 3/8" DR X 10MM SHALLOW SKT (6-PT) | 14166 | 3/8" DR X 10MM SHALLOW SKT (12-PT) | |
| 14143 | 3/8" DR X 11MM SHALLOW SKT (6-PT) | 14167 | 3/8" DR X 11MM SHALLOW SKT (12-PT) | |
| 14144 | 3/8" DR X 12MM SHALLOW SKT (6-PT) | 14168 | 3/8" DR X 12MM SHALLOW SKT (12-PT) | |
| 14145 | 3/8" DR X 13MM SHALLOW SKT (6-PT) | 14169 | 3/8" DR X 13MM SHALLOW SKT (12-PT) | |
| 14146 | 3/8" DR X 14MM SHALLOW SKT (6-PT) | 14170 | 3/8" DR X 14MM SHALLOW SKT (12-PT) | |
| 14147 | 3/8" DR X 15MM SHALLOW SKT (6-PT) | 14171 | 3/8" DR X 15MM SHALLOW SKT (12-PT) | |
| 14148 | 3/8" DR X 16MM SHALLOW SKT (6-PT) | 14172 | 3/8" DR X 16MM SHALLOW SKT (12-PT) | |
| 14149 | 3/8" DR X 17MM SHALLOW SKT (6-PT) | 14173 | 3/8" DR X 17MM SHALLOW SKT (12-PT) | |
| 14151 | 3/8" DR X 18MM SHALLOW SKT (6-PT) | 14174 | 3/8" DR X 18MM SHALLOW SKT (12-PT) | |
| 14152 | 3/8" DR X 19MM SHALLOW SKT (6-PT) | 14175 | 3/8" DR X 19MM SHALLOW SKT (12-PT) | |
| 14153 | 3/8" DR X 21MM SHALLOW SKT (6-PT) | 14176 | 3/8" DR X 21MM SHALLOW SKT (12-PT) | |
| | | | 14206 | 3/8" DR X 1-3/4" EXTENSION BAR |
| | | | 14207 | 3/8" DR X 3" EXTENSION BAR |
| | | | 14208 | 3/8" DR X 6" EXTENSION BAR |
| | | | 14209 | 3/8" DR X 8" EXTENSION BAR |
| | | | 14210 | 3/8" DR UNIVERSAL JOINT |
| | | | 14270 | 3/8" DR (F) X 1/2" DRIVE (M) ADAPTER |
| | | | 14271 | 3/8" DR (F) X 1/4" DRIVE (M) REDUCER |

SOCKET ACCESSORIES

- 14203 3/8" DR X 5/8" SPARK PLUG SOCKET
- 14204 3/8" DR X 3/4" SPARK PLUG SOCKET
- 14205 3/8" DR X 13/16" SPARK PLUG SOCKET

- 14206 3/8" DR X 1-3/4" EXTENSION BAR
- 14207 3/8" DR X 3" EXTENSION BAR
- 14208 3/8" DR X 6" EXTENSION BAR
- 14209 3/8" DR X 8" EXTENSION BAR
- 14210 3/8" DR UNIVERSAL JOINT
- 14270 3/8" DR (F) X 1/2" DRIVE (M) ADAPTER
- 14271 3/8" DR (F) X 1/4" DRIVE (M) REDUCER

COLOR-CODED TABS

SAE sizes
BLACK tabs

METRIC sizes
RED tabs



- Space-Saving Hang Tabs Hold Sockets Securely and Allow Customers Hands-On Interaction with Product
- Easy-to-Read Size, Specifications, and ANSI Rating on Front Side
- Lifetime Warranty and Barcode on Reverse Side

• All Individual Sockets and Accessories are Shipped Case: 144-pcs. and Inner Box: 6-pcs.

1/2" Drive Sockets and Accessories

| SAE SIZES | SHALLOW 6-POINT | SHALLOW 12-POINT | DEEP 6- & 12-POINT |
|--------------|--|---|--|
| | 14273 1/2" DR X 3/8" SHALLOW SKT (6-PT) | 14211 1/2" DR X 3/8" SHALLOW SKT (12-PT) | 14236 1/2" DR X 1/2" DEEP SOCKET (12-PT) |
| | 14274 1/2" DR X 7/16" SHALLOW SKT (6-PT) | 14212 1/2" DR X 7/16" SHALLOW SKT (12-PT) | 14237 1/2" DR X 9/16" DEEP SOCKET (12-PT) |
| | 14275 1/2" DR X 1/2" SHALLOW SKT (6-PT) | 14213 1/2" DR X 1/2" SHALLOW SKT (12-PT) | 14238 1/2" DR X 5/8" DEEP SOCKET (12-PT) |
| | 14276 1/2" DR X 9/16" SHALLOW SKT (6-PT) | 14214 1/2" DR X 9/16" SHALLOW SKT (12-PT) | 14239 1/2" DR X 11/16" DEEP SOCKET (12-PT) |
| | 14277 1/2" DR X 5/8" SHALLOW SKT (6-PT) | 14215 1/2" DR X 5/8" SHALLOW SKT (12-PT) | 14240 1/2" DR X 3/4" DEEP SOCKET (12-PT) |
| | 14278 1/2" DR X 11/16" SHALLOW SKT (6-PT) | 14216 1/2" DR X 11/16" SHALLOW SKT (12-PT) | 14241 1/2" DR X 13/16" DEEP SOCKET (12-PT) |
| | 14279 1/2" DR X 3/4" SHALLOW SKT (6-PT) | 14217 1/2" DR X 3/4" SHALLOW SKT (12-PT) | 14242 1/2" DR X 7/8" DEEP SOCKET (12-PT) |
| | 14280 1/2" DR X 13/16" SHALLOW SKT (6-PT) | 14218 1/2" DR X 13/16" SHALLOW SKT (12-PT) | 14243 1/2" DR X 15/16" DEEP SOCKET (12-PT) |
| | 14281 1/2" DR X 7/8" SHALLOW SKT (6-PT) | 14219 1/2" DR X 7/8" SHALLOW SKT (12-PT) | 14244 1/2" DR X 1/2" DEEP SOCKET (6-PT) |
| | 14282 1/2" DR X 15/16" SHALLOW SKT (6-PT) | 14220 1/2" DR X 15/16" SHALLOW SKT (12-PT) | 14245 1/2" DR X 9/16" DEEP SOCKET (6-PT) |
| | 14283 1/2" DR X 1" SHALLOW SKT (6-PT) | 14221 1/2" DR X 1" SHALLOW SKT (12-PT) | 14246 1/2" DR X 5/8" DEEP SOCKET (6-PT) |
| | 14284 1/2" DR X 1-1/16" SHALLOW SKT (6-PT) | 14222 1/2" DR X 1-1/16" SHALLOW SKT (12-PT) | 14247 1/2" DR X 11/16" DEEP SOCKET (6-PT) |
| | 14285 1/2" DR X 1-1/8" SHALLOW SKT (6-PT) | 14223 1/2" DR X 1-1/8" SHALLOW SKT (12-PT) | 14248 1/2" DR X 3/4" DEEP SOCKET (6-PT) |
| | 14286 1/2" DR X 1-1/4" SHALLOW SKT (6-PT) | 14224 1/2" DR X 1-1/4" SHALLOW SKT (12-PT) | 14249 1/2" DR X 13/16" DEEP SOCKET (6-PT) |
| | | | 14250 1/2" DR X 7/8" DEEP SOCKET (6-PT) |
| | | | 14251 1/2" DR X 15/16" DEEP SOCKET (6-PT) |
| METRIC SIZES | SHALLOW 6-POINT | SHALLOW 12-POINT | DEEP 6-POINT |
| | 14287 1/2" DR X 12MM SHALLOW SKT (6-PT) | 14225 1/2" DR X 12MM SHALLOW SKT (12-PT) | 14252 1/2" DR X 12MM DEEP SOCKET (6-PT) |
| | 14288 1/2" DR X 13MM SHALLOW SKT (6-PT) | 14226 1/2" DR X 13MM SHALLOW SKT (12-PT) | 14253 1/2" DR X 13MM DEEP SOCKET (6-PT) |
| | 14289 1/2" DR X 14MM SHALLOW SKT (6-PT) | 14227 1/2" DR X 14MM SHALLOW SKT (12-PT) | 14254 1/2" DR X 14MM DEEP SOCKET (6-PT) |
| | 14290 1/2" DR X 15MM SHALLOW SKT (6-PT) | 14228 1/2" DR X 15MM SHALLOW SKT (12-PT) | 14255 1/2" DR X 15MM DEEP SOCKET (6-PT) |
| | 14291 1/2" DR X 16MM SHALLOW SKT (6-PT) | 14229 1/2" DR X 16MM SHALLOW SKT (12-PT) | 14256 1/2" DR X 16MM DEEP SOCKET (6-PT) |
| | 14292 1/2" DR X 17MM SHALLOW SKT (6-PT) | 14230 1/2" DR X 17MM SHALLOW SKT (12-PT) | 14257 1/2" DR X 17MM DEEP SOCKET (6-PT) |
| | 14293 1/2" DR X 18MM SHALLOW SKT (6-PT) | 14231 1/2" DR X 18MM SHALLOW SKT (12-PT) | 14258 1/2" DR X 18MM DEEP SOCKET (6-PT) |
| | 14294 1/2" DR X 19MM SHALLOW SKT (6-PT) | 14232 1/2" DR X 19MM SHALLOW SKT (12-PT) | 14259 1/2" DR X 19MM DEEP SOCKET (6-PT) |
| | 14295 1/2" DR X 21MM SHALLOW SKT (6-PT) | 14233 1/2" DR X 21MM SHALLOW SKT (12-PT) | 14260 1/2" DR X 21MM DEEP SOCKET (6-PT) |
| | 14296 1/2" DR X 22MM SHALLOW SKT (6-PT) | 14234 1/2" DR X 22MM SHALLOW SKT (12-PT) | 14261 1/2" DR X 22MM DEEP SOCKET (6-PT) |
| | 14297 1/2" DR X 24MM SHALLOW SKT (6-PT) | 14235 1/2" DR X 24MM SHALLOW SKT (12-PT) | 14262 1/2" DR X 24MM DEEP SOCKET (6-PT) |

| | | | |
|--------------------|--|-----------------------------------|--|
| SOCKET | 14263 1/2" DR X 5/8" SPARK PLUG SOCKET | 14265 1/2" DR X 3" EXTENSION BAR | 14268 1/2" DR UNIVERSAL JOINT |
| ACCESSORIES | 14264 1/2" DR X 13/16" SPARK PLUG SOCKET | 14266 1/2" DR X 5" EXTENSION BAR | 14272 1/2" DR (F) X 3/8" DRIVE (M) REDUCER |
| | | 14267 1/2" DR X 10" EXTENSION BAR | |

Spark Plug and Specialty Sockets

- Drop Forged, Heat Treated Steel Construction
- Corrosion-Resistant Chrome Plated Finish
- Built-in Rubber Grommet Grips Spark Plug for Easy Installation and Removal
- 6-Point Beveled-End Socket
- Notched Drive End Locks onto Ratchet or Extension

- 1828
- Drop Forged, Heat Treated Chrome Vanadium Steel
- Corrosion-Resistant Chrome Plated Finish
- 6-Point Beveled-End Socket
- Notched Drive End Locks onto Ratchet or Extension
- Fits Heating Element in Many Electric Water Heaters

- Drop Forged, Heat Treated Steel Construction
- Corrosion-Resistant Black Oxide Finish
- Built-in Rubber Grommet Grips Spark Plug for Easy Installation and Removal
- 6-Point Beveled-End Socket
- Notched Drive End Locks onto Ratchet or Extension
- Extra Long Design Reaches Spark Plugs on Engines with Overhead Camshafts



| Item | Description | Packaging | Cs | In |
|------|--|--------------------|----|----|
| 1785 | 3/8" Drive x 5/8" Spark Plug Socket | SLIDE BLISTER CARD | 72 | 6 |
| 1788 | 3/8" Drive x 5/8" Extra Long Spark Plug Socket | SLIDE BLISTER CARD | 72 | 12 |
| 1795 | 3/8" Drive x 13/16" Spark Plug Socket | SLIDE BLISTER CARD | 72 | 6 |
| 1828 | 1/2" Drive x 1-1/2" Water Heater Socket | SLIDE BLISTER CARD | 30 | 6 |

12 Bit Sockets

Individual Hex Bit Sockets



- Drop Forged Chrome Vanadium Steel Socket
- Chrome Vanadium Steel Bit with Corrosion-Resistant Black Oxide Finish
- Precision-Machined Tip for Exact Fit
- Notched Socket Locks onto Ratchet or Extension

| Item | Description | Packaging | Cs | In |
|------|-----------------------------------|------------------------|----|----|
| 1370 | 3/8" Drive x 5/32" Hex Bit Socket | PLASTIC HANG TAB/LABEL | 72 | 6 |
| 1371 | 3/8" Drive x 3/16" Hex Bit Socket | PLASTIC HANG TAB/LABEL | 72 | 6 |
| 1372 | 3/8" Drive x 7/32" Hex Bit Socket | PLASTIC HANG TAB/LABEL | 72 | 6 |
| 1373 | 3/8" Drive x 1/4" Hex Bit Socket | PLASTIC HANG TAB/LABEL | 72 | 6 |
| 1374 | 3/8" Drive x 5/16" Hex Bit Socket | PLASTIC HANG TAB/LABEL | 72 | 6 |
| 1375 | 3/8" Drive x 3/8" Hex Bit Socket | PLASTIC HANG TAB/LABEL | 72 | 6 |
| 1376 | 3/8" Drive x 6mm Hex Bit Socket | PLASTIC HANG TAB/LABEL | 72 | 6 |
| 1377 | 3/8" Drive x 8mm Hex Bit Socket | PLASTIC HANG TAB/LABEL | 72 | 6 |
| 1378 | 3/8" Drive x 10mm Hex Bit Socket | PLASTIC HANG TAB/LABEL | 72 | 6 |



10-pc. 3/8" Drive Star Bit Socket Set

- Drop Forged, Heat Treated Carbon Steel Sockets
- Precision-Machined Chrome Vanadium Steel Bits
- Durable Chrome Plated Finish on Sockets and Sandblasted Finish on Bits Resist Corrosion
- 9-pc. 3/8" Drive Star Bit Sockets: SD-10, SD-15, SD-20, SD-25, SD-27, SD-30, SD-40, SD-45, SD-50
- 1-pc. 9-Clip Socket Holder

| Item | Description | Packaging | Cs | In |
|------|---------------------------------------|--------------------|----|----|
| 1351 | 10-pc. 3/8" Drive Star Bit Socket Set | SLIDE BLISTER CARD | 36 | 6 |



7-pc. 3/8" Drive Ball Hex Bit Socket Set (SAE)

- Drop Forged Chrome Vanadium Steel Sockets
- Precision-Machined Chrome Vanadium Steel Bits
- Durable Chrome Plated Finish on Sockets and Brass-Coated Finish on Bits Resist Corrosion
- Notches in Sockets Lock on to Ratchets and Extensions
- 7-pc. Ball Hex Bits (SAE): 1/8", 5/32", 3/16", 7/32", 1/4", 5/16", 3/8"
- Complete with 7-Clip Socket Holder

| Item | Description | Packaging | Cs | In |
|------|--|--------------------|----|----|
| 1358 | 7-pc. 3/8" Drive Ball Hex Bit Socket Set (SAE) | SLIDE BLISTER CARD | 36 | 6 |

10-pc. 3/8" Drive Hex Bit Socket Sets

- Drop Forged, Heat Treated Carbon Steel Sockets
- Precision-Machined Chrome Vanadium Steel Bits
- Durable Chrome Plated Finish on Sockets and Sandblasted Finish on Bits Resist Corrosion



- | | |
|---|--|
| <p>1361</p> <ul style="list-style-type: none"> • 7-pc. Hex Bit Sockets (SAE): 1/8", 5/32", 3/16", 7/32", 1/4", 5/16", 3/8" • 2-pc. Screwdriver Bit Sockets: 1/4" Flat, #2 Phillips • 1-pc. 9-Clip Socket Holder | <p>1366</p> <ul style="list-style-type: none"> • 7-pc. Hex Bit Sockets (Metric): 3, 4, 5, 5.5, 6, 8, 10mm • 2-pc. Screwdriver Bit Sockets: 1/4" Flat, #2 Phillips • 1-pc. 9-Clip Socket Holder |
|---|--|

| Item | Description | Packaging | Cs | In |
|------|---|--------------------|----|----|
| 1361 | 10-pc. 3/8" Drive Hex Bit Socket Set (SAE) | SLIDE BLISTER CARD | 36 | 36 |
| 1366 | 10-pc. 3/8" Drive Hex Bit Socket Set (Metric) | SLIDE BLISTER CARD | 36 | 6 |

10-pc. 3/8" Drive Hex Bit Socket Sets

- Drop Forged, Heat Treated Carbon Steel Sockets
- Precision-Machined Chrome Vanadium Steel Bits
- Durable Chrome Plated Finish on Sockets and Sandblasted Finish on Bits Resist Corrosion

1360

- 7-pc. Hex Bit Sockets (SAE): 1/8", 5/32", 3/16", 7/32", 1/4", 5/16", 3/8"
- 2-pc. Screwdriver Bit Sockets: 1/4" Flat, #2 Phillips
- 1-pc. Storage Case

1365

- 7-pc. Hex Bit Sockets (Metric): 3, 4, 5, 5.5, 6, 8, 10mm
- 2-pc. Screwdriver Bit Sockets: 1/4" Flat, #2 Phillips
- 1-pc. Storage Case



| Item | Description | Packaging | Cs | In |
|------|---|-----------|----|----|
| 1360 | 10-pc. 3/8" Drive Hex Bit Socket Set (SAE) | COLOR BOX | 50 | 50 |
| 1365 | 10-pc. 3/8" Drive Hex Bit Socket Set (Metric) | COLOR BOX | 50 | 1 |

7-pc. 3/8" Drive Extra Long Star Bit Socket Set

- Hardened S-2 Steel Bits with Corrosion-Resistant Black Oxide Finish
- Forged Chrome Vanadium Steel Sockets
- Notched Drive Locks onto Drive Tang
- Use with 3/8" Drive Ratchets
- Two-Piece Design Allows Replacement of Worn or Damaged Bits
- 7-pc. 3/8" Drive Star Bit Sockets: SD-10, 15, 20, 25, 27, 30, 40
- Complete with Storage Case

| Item | Description | Packaging | Cs | In |
|------|---|-----------|----|----|
| 1352 | 7-pc. 3/8" Drive Extra Long Star Bit Socket Set | COLOR BOX | 24 | 24 |



7-pc. 3/8" Drive Extra Long Hex Bit Socket Sets

- Hardened S-2 Steel Bits with Corrosion-Resistant Black Oxide Finish
- Forged Chrome Vanadium Steel Sockets
- Notched Drive Locks onto Drive Tang
- Use with 3/8" Drive Ratchets
- Two-Piece Design Allows Replacement of Worn or Damaged Bits

1362

- 7-pc. 3/8" Drive Hex Bit Sockets (SAE): 1/8", 5/32", 3/16", 7/32", 1/4", 5/16", 3/8"
- Complete with Storage Case

1363

- 7-pc. 3/8" Drive Hex Bit Sockets (Metric): 3, 4, 5, 6, 7, 8, 10mm
- Complete with Storage Case

| Item | Description | Packaging | Cs | In |
|------|---|-----------|----|----|
| 1362 | 7-pc. 3/8" Drive Extra Long Hex Bit Socket Set (SAE) | COLOR BOX | 24 | 24 |
| 1363 | 7-pc. 3/8" Drive Extra Long Hex Bit Socket Set (Metric) | COLOR BOX | 24 | 1 |





Ratchet Handles

- Drop Forged Chrome Vanadium Steel
- Heat Treated and Chrome Plated
- Spring Loaded Ball Bearings Hold Sockets Securely
- Quick-Action Reverse Lever Metal Speed Spin Disc
- Rubber Grips on Handles Provide a Comfortable Grip and Added Torque

| Item | Description | Packaging | Cs | In |
|------|---------------------------------|------------------------|----|----|
| 1445 | 1/4" Drive x 6" Ratchet Handle | PLASTIC HANG TAB/LABEL | 72 | 6 |
| 1450 | 3/8" Drive x 8" Ratchet Handle | PLASTIC HANG TAB/LABEL | 48 | 6 |
| 1455 | 1/2" Drive x 10" Ratchet Handle | PLASTIC HANG TAB/LABEL | 36 | 6 |

Mechanic's Ratchet Handles

- Drop Forged, Heat Treated Chrome Vanadium Steel
- Chrome Plated Finish Resists Corrosion
- Spring-Loaded Ball Bearing Locks on to Sockets
- Built-in Speed Disc

| Item | Description | Packaging | Cs | In |
|------|--|------------------------|----|----|
| 1440 | 1/4" Drive x 6" Mechanic's Ratchet Handle | PLASTIC HANG TAB/LABEL | 72 | 6 |
| 1441 | 3/8" Drive x 8" Mechanic's Ratchet Handle | PLASTIC HANG TAB/LABEL | 48 | 6 |
| 1442 | 1/2" Drive x 10" Mechanic's Ratchet Handle | PLASTIC HANG TAB/LABEL | 36 | 6 |



Mechanic's Flex Ratchet Handles

- 180°, 5-Position Flex Head
- Drop Forged, Heat Treated Chrome Vanadium Steel
- Corrosion-Resistant Chrome Plated Finish
- Spring-Loaded Ball Bearing Locks on to Sockets
- Built-in Speed Disc

| Item | Description | Packaging | Cs | In |
|------|--|------------------------|----|----|
| 1460 | 3/8" Drive x 11" Mechanic's Flex Ratchet Handle | PLASTIC HANG TAB/LABEL | 36 | 6 |
| 1462 | 3/8" Drive x 11" Mechanic's Flex Offset Ratchet Handle | PLASTIC HANG TAB/LABEL | 36 | 6 |
| 1470 | 3/8" Drive x 6" Mechanic's Flex Stubby Ratchet Handle | PLASTIC HANG TAB/LABEL | 60 | 6 |



DIY Ratchet Handles

- Drop Forged Carbon Steel
- Chrome Plated Finish Resists Corrosion
- Spring Loaded Ball Bearing Locks on to Sockets
- Non-Slip Knurled Grip Handle

| Item | Description | Packaging | Cs | In |
|------|---------------------------------|--------------------|----|----|
| 1495 | 1/4" Drive x 5" Ratchet Handle | SLIDE BLISTER CARD | 72 | 12 |
| 1500 | 3/8" Drive x 8" Ratchet Handle | SLIDE BLISTER CARD | 60 | 12 |
| 1505 | 1/2" Drive x 10" Ratchet Handle | SLIDE BLISTER CARD | 50 | 10 |

Jumbo Ratchet Handles

- Drop Forged Steel Construction
- Heat Treated and Chrome Plated
- Spring Loaded Ball Bearings Lock Sockets Securely onto Ratchet Handle
- Durable Cast Steel Reverse Levers
- Knurled Handle for Sure Grip
- Long Lever Arms Provide Superior Leverage

| Item | Description | Packaging | Cs | In |
|------|---------------------------------|------------------|----|----|
| 1540 | 3/4" Drive x 18" Ratchet Handle | BULK/COLOR LABEL | 10 | 1 |
| 1545 | 1" Drive x 26" Ratchet Handle | BULK/COLOR LABEL | 5 | 1 |



1438



1466

Quick-Release Ratchet Handles

- Drop Forged, Heat Treated Chrome Vanadium Steel
- Corrosion-Resistant Chrome Plated Finish
- Comfortable, Non-Slip Soft Grip
- Quick-Release, Lock-On Drive Tang Prevents Dropped or Stuck Sockets

| Item | Description | Packaging | Cs | In |
|------|---|------------------------|----|----|
| 1476 | 1/4" Drive x 6" Quick-Release Ratchet Handle | PLASTIC HANG TAB/LABEL | 72 | 6 |
| 1477 | 3/8" Drive x 8" Quick-Release Ratchet Handle | PLASTIC HANG TAB/LABEL | 48 | 6 |
| 1478 | 1/2" Drive x 10" Quick-Release Ratchet Handle | PLASTIC HANG TAB/LABEL | 24 | 6 |

Finger/Palm Ratchets

- 1438**
- Forged, Heat-Treated Carbon Steel Construction
 - Corrosion-Resistant Chrome Plated Finish
 - Forward and Reverse Drive
 - Non-Slip, Knurled Finger Grip
 - Designed for Extra Speed, Especially in Tight Spaces

- 1466**
- Solid, Cast, Contoured Finger Grip Body
 - Corrosion-Resistant Chrome Plated Finish
 - Hardened Chrome Vanadium Steel Ratchet Construction
 - Compact Size for Tight Work Areas

| Item | Description | Packaging | Cs | In |
|------|------------------------------------|--------------------|----|----|
| 1438 | 3/8" Drive Speed Ratchet | SLIDE BLISTER CARD | 96 | 6 |
| 1466 | 3/8" Drive Mechanic's Palm Ratchet | SLIDE BLISTER CARD | 60 | 6 |



1395

7-pc. Nut Driver Set

- Drop Forged Carbon Steel Construction
- Corrosion-Resistant Nickel Plated Finish
- Color Coded Handles for Easy Size Selection
- 7-pc. Nut Drivers (SAE): 3/16, 1/4, 5/16, 11/32, 3/8, 7/16, 1/2"



1406

14-pc. Nut Driver Set

- Drop Forged Carbon Steel Construction
- Corrosion-Resistant Zinc Plated Finish
- Color Coded Handles for Easy Size Selection
- 7-pc. Nut Drivers (SAE): 3/16", 1/4", 5/16", 11/32", 3/8", 7/16", 1/2"
- 7-pc. Nut Drivers (Metric): 5, 6, 7, 9, 10, 11, 12mm

| Item | Description | Packaging | Cs | In |
|------|-----------------------|-----------------------|----|----|
| 1395 | 7-pc. Nut Driver Set | SEALED BLISTER - FULL | 48 | 6 |
| 1406 | 14-pc. Nut Driver Set | SEALED BLISTER - FULL | 24 | 4 |



7-pc. Pro Nut Driver Sets

- Drop Forged and Hardened Carbon Steel
- Corrosion-Resistant Chrome Plated Finish
- Color Coded Handles for Easy Size Selection

- 1398**
- 7-pc. Nut Drivers (SAE): 3/16, 1/4, 5/16, 11/32, 3/8, 7/16, 1/2"
- 1399**
- 7-pc. Nut Drivers (Metric): 5, 6, 7, 8, 10, 11, 12mm

| Item | Description | Packaging | Cs | In |
|------|--------------------------|-----------------------|----|----|
| 1398 | 7-pc. Pro Nut Driver Set | SEALED BLISTER - FULL | 40 | 5 |
| 1399 | 7-pc. Pro Nut Driver Set | SEALED BLISTER - FULL | 40 | 5 |



3/8" Drive x 12" Mechanic's Flex Breaker Bar

- Forged and Hardened Chrome Vanadium Steel
- Corrosion-Resistant Chrome Plated Finish
- 180° Flex Head
- Spring-Loaded Ball Bearing Locks on to Sockets

| Item | Description | Packaging | Cs | In |
|------|--|------------------------|----|----|
| 1695 | 3/8" Drive x 12" Mechanic's Flex Breaker Bar | PLASTIC HANG TAB/LABEL | 50 | 5 |



1/2" Drive x 15" Pro Flex Breaker Bar

- Forged, Heat Treated Carbon Steel
- Corrosion-Resistant Chrome Plated Finish
- 180° Flex Head
- Non-Slip Textured Rubber Handle Grip
- Spring-Loaded Ball Bearing Locks on to Sockets

| Item | Description | Packaging | Cs | In |
|------|---------------------------------------|------------------------|----|----|
| 1701 | 1/2" Drive x 15" Pro Flex Breaker Bar | PLASTIC HANG TAB/LABEL | 24 | 6 |



1/2" Drive x 16" Mechanic's Flex Breaker Bar

- Forged and Hardened Chrome Vanadium Steel
- Corrosion-Resistant Chrome Plated Finish
- 180° Flex Head
- Non-Slip Knurled Handle Grip
- Spring-Loaded Ball Bearing Locks on to Sockets

| Item | Description | Packaging | Cs | In |
|------|--|------------------------|----|----|
| 1702 | 1/2" Drive x 16" Mechanic's Flex Breaker Bar | PLASTIC HANG TAB/LABEL | 30 | 5 |



1/2" Drive x 25" Mechanic's Flex Breaker Bar

- Forged and Hardened Chrome Vanadium Steel
- Corrosion-Resistant Chrome Plated Finish
- 180° Flex Chrome Molybdenum Head
- Spring-Loaded Ball Bearing Locks on to Sockets

| Item | Description | Packaging | Cs | In |
|------|--|------------------|----|----|
| 1703 | 1/2" Drive x 25" Mechanic's Flex Breaker Bar | BULK/COLOR LABEL | 20 | 5 |



3/4" Drive x 24" Flex Breaker Bar

- Forged and Hardened Carbon Steel Construction
- Corrosion-Resistant Chrome Plated Finish
- 180° Flex Head
- Non-Slip Knurled Handle Grip
- Spring-Loaded Ball Bearing Locks on to Sockets

| Item | Description | Packaging | Cs | In |
|------|-----------------------------------|------------------|----|----|
| 1705 | 3/4" Drive x 24" Flex Breaker Bar | BULK/COLOR LABEL | 12 | 1 |



3-pc. Extension Bar Sets

- Drop Forged Carbon Steel
- Durable Chrome Plated Finish Resists Corrosion
- Spring Loaded Ball Bearing Locks on to Sockets

- 1595 • 3-pc. 1/4" Dr. Extensions: 3", 6", 9"
- 1600 • 3-pc. 3/8" Dr. Extensions: 3", 6", 8"
- 1605 • 3-pc. 1/2" Dr. Extensions: 3", 6", 8"

| Item | Description | Packaging | Cs | In |
|------|------------------------------------|------------------------|----|----|
| 1595 | 3-pc. 1/4" Drive Extension Bar Set | PLASTIC HANG TAB/LABEL | 40 | 10 |
| 1600 | 3-pc. 3/8" Drive Extension Bar Set | PLASTIC HANG TAB/LABEL | 30 | 10 |
| 1605 | 3-pc. 1/2" Drive Extension Bar Set | PLASTIC HANG TAB/LABEL | 30 | 10 |



3-pc. Extra Long Extension Bar Sets

- Drop Forged Carbon Steel
- Durable Chrome Plated Finish Resists Corrosion
- Spring-Loaded Ball Bearing Locks on to Sockets
- Notches on Extension Lock onto Ratchet Drive

- 1610 • 3-pc. 3/8" Dr. Extensions: 15", 18", 24"
- 1615 • 3-pc. 1/2" Dr. Extensions: 15", 18", 24"

| Item | Description | Packaging | Cs | In |
|------|---|------------------------|----|----|
| 1610 | 3-pc. 3/8" Drive Extra Long Extension Bar Set | PLASTIC HANG TAB/LABEL | 12 | 6 |
| 1615 | 3-pc. 1/2" Drive Extra Long Extension Bar Set | PLASTIC HANG TAB/LABEL | 10 | 5 |



3-pc. 3/4" Drive Extension Bar Set

- Drop Forged Heat Treated Carbon Steel
- Durable Chrome Plated Finish Resists Corrosion
- Spring-Loaded Ball Bearing Locks on to Sockets
- Notches on Extension Lock onto Ratchet Drive

- 3-pc. 3/4" Dr. Extensions: 8", 10", 12"
- Complete with Divided Storage Pouch

| Item | Description | Packaging | Cs | In |
|------|------------------------------------|-----------|----|----|
| 1630 | 3-pc. 3/4" Drive Extension Bar Set | POUCH/UPC | 10 | 1 |



9-pc. Combination Wobble Extension Bar Set

- Drop Forged, Heat Treated Chrome Vanadium Steel
- Corrosion-Resistant Chrome Plated Finish
- Knurled-Pattern Grip Area for Sure, Non-Slip Handling
- Spring-Loaded Ball Bearing Retains Socket
- Unique, Combination Design Fits into Socket in Two Positions: Fully Inserted for Standard Extension or Partially Inserted for Wobble Extension, Providing Offset Clearance for Hard-to-Reach Fasteners

- 3-pc. 1/4" Dr. Extensions: 2", 4", 9"
- 3-pc. 3/8" Dr. Extensions: 3", 6", 9"
- 3-pc. 1/2" Dr. Extensions: 1-3/4", 5", 10"

| Item | Description | Packaging | Cs | In |
|------|--|-----------|----|----|
| 1660 | 9-pc. Combination Wobble Extension Bar Set | COLOR BOX | 16 | 1 |



Universal Joints

- Drop Forged Carbon Steel
- Durable Chrome Plated Finish Resists Corrosion
- Spring-Loaded Ball Bearing Locks on to Sockets

1730

- 3-pc. Universal Joints: 1/4" Dr. (F) x 1/4" Dr. (M), 3/8" Dr. (F) x 3/8" Dr. (M), 1/2" Dr. (F) x 1/2" Dr. (M)

| Item | Description | Packaging | Cs | In |
|------|----------------------------|--------------------|-----|----|
| 1730 | 3-pc. Universal Joint Set | SLIDE BLISTER CARD | 120 | 10 |
| 1735 | 1/4" Drive Universal Joint | SLIDE BLISTER CARD | 360 | 12 |
| 1740 | 3/8" Drive Universal Joint | SLIDE BLISTER CARD | 216 | 12 |
| 1745 | 1/2" Drive Universal Joint | SLIDE BLISTER CARD | 144 | 12 |



3-pc. Ratchet Adapter Set

- Drop Forged Carbon Steel
- Durable Chrome Plated Finish Resists Corrosion
- Spring-Loaded Ball Bearing Locks on to Sockets

- 1-pc. 1/4" Dr. (F) x 3/8" Dr. (M) Adapter
- 1-pc. 3/8" Dr. (F) x 1/2" Dr. (M) Adapter
- 1-pc. 1/2" Dr. (F) x 3/4" Dr. (M) Adapter

| Item | Description | Packaging | Cs | In |
|------|---------------------------|--------------------|----|----|
| 1770 | 3-pc. Ratchet Adapter Set | SLIDE BLISTER CARD | 96 | 96 |



3-pc. Ratchet Reducer Set

- Drop Forged Carbon Steel
- Durable Chrome Plated Finish Resists Corrosion
- Spring-Loaded Ball Bearing Locks on to Sockets

- 1-pc. 3/8" Dr. (F) x 1/4" Dr. (M) Reducer
- 1-pc. 1/2" Dr. (F) x 3/8" Dr. (M) Reducer
- 1-pc. 3/4" Dr. (F) x 1/2" Dr. (M) Reducer

| Item | Description | Packaging | Cs | In |
|------|---------------------------|--------------------|----|----|
| 1775 | 3-pc. Ratchet Reducer Set | SLIDE BLISTER CARD | 96 | 96 |



Socket Holders

- Nickel Plated Steel Construction with Spring-Steel Socket Clips
- Holds 16 Sockets Each
- Carry in Tool Box or Mount to Wall or Workbench

1885

- 3-pc. 16-Clip Socket Holders: 1/4" Drive, 3/8" Drive, 1/2" Drive

| Item | Description | Packaging | Cs | In |
|------|--|--------------|-----|----|
| 1885 | 3-pc. 1/4", 3/8", 1/2" Drive Socket Holder Set | BLISTER CARD | 50 | 5 |
| 1890 | 1/4" Drive Pro Socket Holder | BLISTER CARD | 100 | 10 |
| 1895 | 3/8" Drive Pro Socket Holder | BLISTER CARD | 100 | 10 |
| 1900 | 1/2" Drive Pro Socket Holder | BLISTER CARD | 100 | 10 |

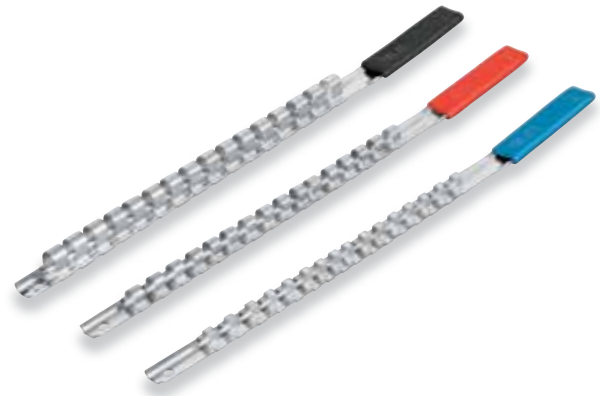

Pro Socket Holders

- Nickel Plated Steel Construction with Spring-Steel Socket Clips
- Color-Coded Non-Slip Handle Grips for Quick Size Reference
- Holds 16 Sockets Each

1887

- 3-pc. Socket Holders: 1/4", 3/8", 1/2"

| Item | Description | Packaging | Cs | In |
|------|--|------------------------|----|----|
| 1887 | 3-pc. 1/4", 3/8", 1/2" Drive Pro Socket Holder Set | PLASTIC HANG TAB/LABEL | 24 | 4 |
| 1891 | 1/4" Drive Socket Holder | PLASTIC HANG TAB/LABEL | 72 | 6 |
| 1896 | 3/8" Drive Socket Holder | PLASTIC HANG TAB/LABEL | 72 | 6 |
| 1901 | 1/2" Drive Socket Holder | PLASTIC HANG TAB/LABEL | 72 | 6 |



Round Magnetic Parts Tray

- Heavy-Gauge Polished Stainless Steel
- Soft Covering Over Magnet Prevents Damage to Finished Surfaces
- Mounts to Hood, Fenders, or Other Ferrous Metal Surfaces Around Work Area
- Keeps Nuts and Bolts, Parts, and Small Tools within Reach
- Prevents Lost or Misplaced Parts and Fasteners
- Capacity: 2 Lbs.
- Dimensions: 5-1/2" Diameter, 1-1/8" Deep

| Item | Description | Packaging | Cs | In |
|------|---------------------------|-----------------------|----|----|
| 1902 | Round Magnetic Parts Tray | SEALED BLISTER - FULL | 36 | 6 |



Rectangle Magnetic Parts Tray

- Heavy-Gauge Polished Stainless Steel
- Soft Covering Over Magnets Prevents Damage to Finished Surfaces
- Mounts to Hood, Fenders, or Other Ferrous Metal Surfaces Around Work Area
- Keeps Nuts and Bolts, Parts, and Small Tools within Reach
- Prevents Lost or Misplaced Parts and Fasteners
- Capacity: 4 Lbs.
- Dimensions: 9-1/16" L x 5-5/16" W x 1-5/16" D

| Item | Description | Packaging | Cs | In |
|------|-------------------------------|-----------------------|----|----|
| 1903 | Rectangle Magnetic Parts Tray | SEALED BLISTER - FULL | 24 | 4 |

20 Wrenches



9-pc. Combination Wrench Sets

- Drop Forged Chrome Vanadium Steel
- Heat Treated and Chrome Plated
- 15° Angled Open Ends
- Precision-Machined 12-Point Box Ends
- Meets or Exceeds ANSI Specifications

1910

- 9-pc. Combination Wrenches (SAE): 1/4", 5/16", 3/8", 7/16", 1/2", 9/16", 5/8", 11/16", 3/4"
- Complete with Storage Rack

1911

- 9-pc. Combination Wrenches (Metric): 6, 8, 10, 12, 13, 15, 17, 18, 19mm
- Complete with Storage Rack

| Item | Description | Packaging | Cs | In |
|------|---------------------------------------|-------------------------|----|----|
| 1910 | 9-pc. Combination Wrench Set (SAE) | PLASTIC HANG RACK/LABEL | 18 | 3 |
| 1911 | 9-pc. Combination Wrench Set (Metric) | PLASTIC HANG RACK/LABEL | 18 | 3 |



11-pc. Combination Wrench Sets

- Drop Forged Chrome Vanadium Steel
- Heat Treated and Chrome Plated
- 15° Angled Open Ends
- Precision-Machined 12-Point Box Ends
- Meets or Exceeds ANSI Specifications

1912

- 11-pc. Combination Wrenches (SAE): 1/4", 5/16", 3/8", 7/16", 1/2", 9/16", 5/8", 11/16", 3/4", 13/16", 7/8"
- Complete with Storage Rack

1913

- 11-pc. Combination Wrenches (Metric): 8, 10, 11, 12, 13, 14, 15, 16, 17, 18, 19mm
- Complete with Storage Rack

| Item | Description | Packaging | Cs | In |
|------|--|-------------------------|----|----|
| 1912 | 11-pc. Combination Wrench Set (SAE) | PLASTIC HANG RACK/LABEL | 12 | 3 |
| 1913 | 11-pc. Combination Wrench Set (Metric) | PLASTIC HANG RACK/LABEL | 12 | 3 |



SAE/Metric Combination Wrench Sets

- Drop Forged Chrome Vanadium Steel
- Heat Treated and Chrome Plated
- 15° Angled Open Ends
- Precision-Machined 12-Point Box Ends
- Meets or Exceeds ANSI Specifications

1917

- 6-pc. Stubby (SAE): 3/8", 7/16", 1/2", 9/16", 5/8", 11/16"
- 6-pc. Stubby (Metric): 10, 11, 12, 14, 16, 19mm
- 9-pc. Long (SAE): 1/4", 5/16", 3/8", 7/16", 1/2", 9/16", 5/8", 3/4", 7/8"
- 9-pc. Long (Metric): 7, 8, 9, 10, 12, 13, 15, 17, 18mm
- Complete with Storage Rack

1924

- 7-pc. (SAE): 5/16", 3/8", 7/16", 1/2", 9/16", 5/8", 3/4"
- 7-pc. (Metric): 8, 10, 12, 13, 15, 17, 19mm
- Complete with Storage Rack

| Item | Description | Packaging | Cs | In |
|------|--|-------------------------|----|----|
| 1917 | 30-pc. Combination Wrench Set (SAE/Metric) | PLASTIC HANG RACK/LABEL | 4 | 2 |
| 1924 | 14-pc. Combination Wrench Set (SAE/Metric) | PLASTIC HANG RACK/LABEL | 16 | 4 |



Stubby Combination Wrench Sets

- Drop Forged Chrome Vanadium Steel
- Heat Treated and Chrome Plated
- 15° Angled Open Ends
- Precision-Machined 12-Point Box Ends
- Meets or Exceeds ANSI Specifications

1920

- 8-pc. Combination Wrenches (SAE): 7/16", 1/2", 9/16", 5/8", 11/16", 3/4", 15/16", 1"
- Complete with Storage Rack

1921

- 10-pc. Combination Wrenches (Metric): 10, 11, 12, 13, 14, 15, 16, 17, 18, 19mm
- Complete with Storage Rack

| Item | Description | Packaging | Cs | In |
|------|---|-------------------------|----|----|
| 1920 | 8-pc. Stubby Combination Wrench Set (SAE) | PLASTIC HANG RACK/LABEL | 12 | 3 |
| 1921 | 10-pc. Stubby Combination Wrench Set (Metric) | PLASTIC HANG RACK/LABEL | 12 | 3 |



Stubby Combination Wrench Sets

- Drop Forged Heat Treated Carbon Steel
- Corrosion-Resistant Chrome Plated Finish
- 15° Angled Open Ends
- Precision-Machined 12-Point Box Ends
- Compact Size for Tight Work Areas
- Meets or Exceeds ANSI Specifications

1918

- 8-pc. Stubby Wrenches (SAE): 7/16, 1/2, 9/16, 5/8, 11/16, 3/4, 15/16, 1"
- Complete with Storage Case

1919

- 10-pc. Stubby Wrenches (Metric): 10, 11, 12, 13, 14, 15, 16, 17, 18, 19mm
- Complete with Storage Case

| Item | Description | Packaging | Cs | In |
|------|---|----------------------|----|----|
| 1918 | 8-pc. Stubby Combination Wrench Set (SAE) | BLOW MOLD TRAY/LABEL | 24 | 6 |
| 1919 | 10-pc. Stubby Combination Wrench Set (Metric) | BLOW MOLD TRAY/LABEL | 24 | 6 |



11-pc. Combination Wrench Sets

- Drop Forged Heat Treated Carbon Steel
- Corrosion-Resistant Chrome Plated Finish
- Precision-Machined 15° Angled Open Ends and 12-Point Offset Box Ends
- Meets or Exceeds ANSI Specifications

1925

- 11-pc. Combination Wrenches (SAE): 3/8, 7/16, 1/2, 9/16, 5/8, 11/16, 3/4, 13/16, 7/8, 15/16, 1"
- Complete with Roll-Up Storage Pouch

1930

- 11-pc. Combination Wrenches (Metric): 6, 8, 9, 10, 11, 12, 13, 15, 17, 18, 19mm
- Complete with Roll-Up Storage Pouch

| Item | Description | Packaging | Cs | In |
|------|--|-----------|----|----|
| 1925 | 11-pc. Combination Wrench Set (SAE) | COLOR BOX | 12 | 1 |
| 1930 | 11-pc. Combination Wrench Set (Metric) | COLOR BOX | 12 | 1 |



24-pc. Combination Wrench Set (SAE/Metric)

- Drop Forged Heat Treated Chrome Vanadium Steel
- Corrosion-Resistant Chrome Plated Finish
- Raised Panel for Added Strength
- Precision Machined 15° Angled Open Ends and 12-Point Offset Box Ends
- Meets or Exceeds ANSI Specifications

- 12-pc. (SAE): 1/4", 5/16", 3/8", 7/16", 1/2", 9/16", 5/8", 11/16", 3/4", 13/16", 7/8", 1"
- 12-pc. (Metric): 8, 10, 11, 12, 13, 14, 15, 17, 18, 19, 21, 24mm
- Complete with Roll-Up Storage Pouch

| Item | Description | Packaging | Cs | In |
|------|--|-----------|----|----|
| 1916 | 24-pc. Combination Wrench Set (SAE/Metric) | COLOR BOX | 6 | 1 |



14- and 15-pc. Combination Wrench Sets

- Drop Forged, Heat Treated Carbon Steel
- Polished, Corrosion-Resistant Chrome Plated Finish
- Precision-Machined 15° Angled Open Ends and 12-Point Offset Box Ends
- Meets or Exceeds ANSI Specifications

1940

- 14-pc. Combination Wrenches (SAE): 3/8, 7/16, 1/2, 9/16, 5/8, 11/16, 3/4, 13/16, 7/8, 15/16, 1, 1-1/16, 1-1/8, 1-1/4"
- Complete with Roll-Up Storage Pouch

1947

- 15-pc. Combination Wrenches (Metric): 10, 11, 12, 13, 14, 15, 16, 17, 18, 19, 20, 21, 22, 23, 24mm
- Complete with Roll-Up Storage Pouch

| Item | Description | Packaging | Cs | In |
|------|--|-------------------|----|----|
| 1940 | 14-pc. Combination Wrench Set (SAE) | COLOR BOX | 6 | 1 |
| 1947 | 15-pc. Combination Wrench Set (Metric) | POUCH/COLOR LABEL | 10 | 1 |



MaxTorq™ Combination Wrench Sets

- Drop Forged, Heat Treated High Carbon Steel
- Corrosion-Resistant Triple-Chrome-Plated and Polished Finish
- 15° Angled MaxTorq™ Open End Design Grips Fastener Head on Four Sides, Applying Twice the Torque of Standard Wrenches
- Precision-Machined 12-Point Offset Box Ends
- Long Pattern, Thin Panel Wrenches for Extra Leverage and Long Reach into Tight Spaces
- Meets or Exceeds ANSI Specifications

1937

- 14-pc. Combination Wrenches (SAE): 3/8", 7/16", 1/2", 9/16", 5/8", 11/16", 3/4", 13/16", 7/8", 15/16", 1", 1-1/16", 1-1/8", 1-1/4"
- Complete with Roll-Up Storage Pouch

1938

- 16-pc. Combination Wrenches (Metric): 10, 11, 12, 13, 14, 15, 16, 17, 18, 19, 21, 23, 24, 27, 30, 32mm
- Complete with Roll-Up Storage Pouch

| Item | Description | Packaging | Cs | In |
|------|---|-----------|----|----|
| 1937 | 14-pc. MaxTorq™ Combination Wrench Set (SAE) | COLOR BOX | 4 | 1 |
| 1938 | 16-pc. MaxTorq™ Combination Wrench Set (Metric) | COLOR BOX | 4 | 1 |



Angle Open End Wrench Sets

- Drop Forged, Heat Treated Carbon Steel
- Polished, Corrosion-Resistant Chrome Plated Finish
- Precision-Machined 15° and 45° Angled Open Ends
- Meets or Exceeds ANSI Specifications

2008

- 14-pc. Angle Open End Wrenches (SAE): 3/8", 7/16", 1/2", 9/16", 5/8", 11/16", 3/4", 13/16", 7/8", 15/16", 1", 1-1/16", 1-1/8", 1-1/4"
- Complete with Roll-Up Storage Pouch

2009

- 15-pc. Angle Open End Wrenches (Metric): 10, 11, 12, 13, 14, 15, 16, 17, 18, 19, 20, 21, 22, 23, 24mm
- Complete with Roll-Up Storage Pouch

| Item | Description | Packaging | Cs | In |
|------|---|-------------------|----|----|
| 2008 | 14-pc. Angle Open End Wrench Set (SAE) | POUCH/COLOR LABEL | 6 | 3 |
| 2009 | 15-pc. Angle Open End Wrench Set (Metric) | POUCH/COLOR LABEL | 6 | 1 |

14-pc. Combination Wrench Set (SAE)

- Drop Forged Chrome Vanadium Steel
- Heat Treated and Chrome Plated
- Precision-Machined 12-Point Box Ends
- 15° Angled Open Ends
- Meets or Exceeds ANSI Standards
- 14-pc. Combination Wrenches (SAE): 3/8", 7/16", 1/2", 9/16", 5/8", 11/16", 3/4", 13/16", 7/8", 15/16", 1", 1-1/16", 1-1/8", 1-1/4"
- Complete with Roll-Up Storage Pouch

| Item | Description | Packaging | Cs | In |
|------|-------------------------------------|-----------|----|----|
| 1942 | 14-pc. Combination Wrench Set (SAE) | COLOR BOX | 6 | 1 |



Jumbo Angle Open End Wrench Sets

- Drop Forged Heat Treated Carbon Steel
- Corrosion-Resistant Chrome Plated Finish
- Raised Panel for Added Strength
- Precision Machined 15° and 45° Angled Open Ends
- Meets or Exceeds ANSI Specifications

1958

- 4-pc. Open End Wrenches (SAE): 1-5/16", 1-3/8", 1-7/16", 1-1/2"
- Complete with Roll-Up Storage Pouch

1959

- 6-pc. Open End Wrenches (SAE): 1-3/8", 1-1/2", 1-5/8", 1-3/4", 1-7/8", 2"

| Item | Description | Packaging | Cs | In |
|------|---|-------------------|----|----|
| 1958 | 4-pc. Jumbo Angle Open End Wrench Set (SAE) | POUCH/COLOR LABEL | 6 | 3 |
| 1959 | 6-pc. Jumbo Angle Open End Wrench Set (SAE) | CORRUGATED BOX | 2 | 1 |



6-pc. Jumbo Combination Wrench Sets

- Drop Forged Heat Treated Carbon Steel
- Corrosion-Resistant Chrome Plated Finish
- Raised Panel for Added Strength
- Precision Machined 15° Angled Open Ends and 12-Point Offset Box Ends
- Meets or Exceeds ANSI Specifications

1960

- 6-pc. Jumbo Combination Wrenches (SAE): 1-3/8", 1-1/2", 1-5/8", 1-3/4", 1-7/8", 2"

1961

- 6-pc. Jumbo Combination Wrenches (Metric): 27, 30, 32, 33, 34, 35mm

| Item | Description | Packaging | Cs | In |
|------|---|----------------|----|----|
| 1960 | 6-pc. Jumbo Combination Wrench Set (SAE) | COLOR BOX | 2 | 1 |
| 1961 | 6-pc. Jumbo Combination Wrench Set (Metric) | CORRUGATED BOX | 2 | 1 |



4-pc. Jumbo Combination Wrench Set

- Drop Forged Heat Treated Carbon Steel
- Corrosion-Resistant Chrome Plated Finish
- Raised Panel for Added Strength
- Precision Machined 15° Angled Open Ends and 12-Point Offset Box Ends
- Meets or Exceeds ANSI Specifications

- 4-pc. Jumbo Combination Wrenches (SAE): 1-5/16, 1-3/8, 1-7/16, 1-1/2"
- Complete with Roll-Up Storage Pouch

| Item | Description | Packaging | Cs | In |
|------|------------------------------------|-------------------|----|----|
| 1955 | 4-pc. Jumbo Combination Wrench Set | POUCH/COLOR LABEL | 6 | 1 |



10-pc. Jumbo Combination Wrench Sets

- Drop Forged Heat Treated Carbon Steel
- Corrosion-Resistant Chrome Plated Finish
- Raised Panel for Added Strength
- Precision Machined 15° Angled Open Ends and 12-Point Offset Box Ends
- Meets or Exceeds ANSI Specifications

1962

- 10-pc. Jumbo Combination Wrenches (SAE): 1-5/16, 1-3/8, 1-7/16, 1-1/2, 1-5/8, 1-11/16, 1-3/4, 1-13/16, 1-7/8, 2"

1963

- 10-pc. Jumbo Combination Wrenches (Metric): 34, 36, 38, 41, 42, 44, 45, 46, 48, 50mm

| Item | Description | Packaging | Cs | In |
|------|--|----------------|----|----|
| 1962 | 10-pc. Jumbo Combination Wrench Set (SAE) | CORRUGATED BOX | 2 | 1 |
| 1963 | 10-pc. Jumbo Combination Wrench Set (Metric) | CORRUGATED BOX | 2 | 1 |



10-pc. Jumbo Combination Wrench Set (SAE)

- Industrial Grade Drop Forged Carbon Steel Construction
- Corrosion-Resistant Chrome Plated Finish
- 15° Angled Open Ends
- Precision-Machined Offset 12-Point Box Ends

- 10-pc. Jumbo Combination Wrenches: 1-5/16", 1-3/8", 1-7/16", 1-1/2", 1-5/8", 1-11/16", 1-3/4", 1-13/16", 1-7/8", 2"
- Complete with Heavy Duty Roll-Up Storage Pouch with Carry Handle

| Item | Description | Packaging | Cs | In |
|-------|---|------------------|----|----|
| 19621 | 10-pc. Jumbo Combination Wrench Set (SAE) | PLAIN BOX/NO UPC | 2 | 1 |

24 Wrenches



1965
1967

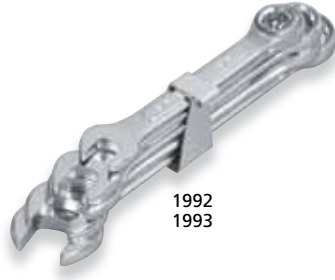

1992
1993



2205
2210



2216
2217

5-pc. Combination Wrench Sets

- Drop Forged Heat Treated Carbon Steel
- Polished Chrome Plated Finish Resists Corrosion
- Precision Machined 15° Angled Open Ends and 12-Point Offset Box Ends
- Meets or Exceeds ANSI Specifications

- 1965 • 5-pc. Combination Wrenches (SAE): 3/8, 7/16, 1/2, 9/16, 5/8"
 1967 • 5-pc. Combination Wrenches (Metric): 10, 11, 12, 13, 14mm
 1992 • 5-pc. Combination Wrenches (SAE): 3/8", 7/16", 1/2", 9/16", 5/8"
 1993 • 5-pc. Combination Wrenches (Metric): 8, 10, 12, 13, 17mm

| Item | Description | Packaging | Cs | In |
|------|---------------------------------------|--------------------|----|----|
| 1965 | 5-pc. Combination Wrench Set (SAE) | SLIDE BLISTER CARD | 36 | 6 |
| 1967 | 5-pc. Combination Wrench Set (Metric) | SLIDE BLISTER CARD | 36 | 6 |
| 1992 | 5-pc. Combination Wrench Set (SAE) | SLIDE BLISTER CARD | 36 | 6 |
| 1993 | 5-pc. Combination Wrench Set (Metric) | SLIDE BLISTER CARD | 36 | 6 |

Ratchet Box End Wrench Sets

- Rugged Carbon Steel and Nylon Housing
- Corrosion-Resistant Chrome Plated Finish
- Precision-Machined 6- and 12-Point Box Ends
- Lever Selector Reverses Drive Without Removing Tool from Fastener

- 2205 • 5-pc. Box End Ratchet Wrenches (SAE): 7/32" x 9/32", 1/4" x 5/16", 3/8" x 7/16", 1/2" x 9/16", 5/8" x 3/4"
 2210 • 5-pc. Box End Ratchet Wrenches (Metric): 5.5 x 7, 6 x 8, 9 x 10, 13 x 14, 16 x 19mm
 2216 • 3-pc. Box End Ratchet Wrenches (SAE): 3/8" x 7/16", 1/2" x 9/16", 5/8" x 3/4"
 2217 • 3-pc. Box End Ratchet Wrenches (Metric): 10 x 12, 13 x 14, 15 x 17mm

| Item | Description | Packaging | Cs | In |
|------|--|-----------------------|----|----|
| 2205 | 5-pc. Ratchet Box End Wrench Set (SAE) | SEALED BLISTER - HALF | 24 | 6 |
| 2210 | 5-pc. Ratchet Box End Wrench Set (Metric) | SEALED BLISTER - HALF | 24 | 6 |
| 2216 | 3-pc. Ratchet Offset Box End Wrench Set (SAE) | SEALED BLISTER - HALF | 36 | 6 |
| 2217 | 3-pc. Ratchet Offset Box End Wrench Set (Metric) | SEALED BLISTER - HALF | 36 | 6 |



7-pc. Ratcheting Combination Wrench Sets

- Drop Forged Heat Treated Steel Construction
- Corrosion-Resistant Chrome Plated Finish
- 15-Degree Angle Open End
- 72-Teeth Chrome Vanadium Ratcheting Box End
- Meets or Exceeds ANSI Specifications

- 2100
 • 7-pc. Ratcheting Combination Wrenches (SAE): 5/16", 3/8", 7/16", 1/2", 9/16", 5/8", 3/4"
 • Complete with Organizer/Storage Rack
 2104
 • 7-pc. Ratcheting Combination Wrenches (MM): 8, 10, 12, 13, 14, 15, 18 mm
 • Complete with Organizer/Storage Rack

| Item | Description | Packaging | Cs | In |
|------|--|-------------------------|----|----|
| 2100 | 7-pc. Ratcheting Combination Wrench Set (SAE) | PLASTIC HANG RACK/LABEL | 20 | 2 |
| 2104 | 7-pc. Ratcheting Combination Wrench Set (Metric) | PLASTIC HANG RACK/LABEL | 20 | 2 |



10-pc. Ratcheting Combination Wrench Sets

- Drop Forged Heat Treated Steel Construction
- Corrosion-Resistant Chrome Plated Finish
- 15-Degree Angle Open End
- 72-Teeth Chrome Vanadium Ratcheting Box End
- Meets or Exceeds ANSI Specifications

- 2107
 • 10-pc. Ratcheting Combination Wrenches (SAE): 1/4", 5/16", 3/8", 7/16", 1/2", 9/16", 5/8", 11/16", 3/4", 7/8"
 • Complete with Organizer/Storage Rack
 2110
 • 10-pc. Ratcheting Combination Wrenches (MM): 8, 9, 10, 11, 12, 13, 15, 17, 18, 19mm
 • Complete with Organizer/Storage Rack

| Item | Description | Packaging | Cs | In |
|------|---|-------------------------|----|----|
| 2107 | 10-pc. Ratcheting Combination Wrench Set (SAE) | PLASTIC HANG RACK/LABEL | 12 | 2 |
| 2110 | 10-pc. Ratcheting Combination Wrench Set (Metric) | PLASTIC HANG RACK/LABEL | 12 | 2 |

Individual Combination Wrenches

- Drop Forged Heat Treated Carbon Steel
- Polished Chrome Plated Finish
- Precision Machined 15° Angled Open End and 12-Point Offset Box End
- Meets or Exceeds ANSI Specifications

| Item | Description | Packaging | Cs | In |
|-------|----------------------------|------------------------|-----|----|
| 21231 | 6mm Combination Wrench | PLASTIC HANG TAB/LABEL | 200 | 10 |
| 21241 | 7mm Combination Wrench | PLASTIC HANG TAB/LABEL | 200 | 10 |
| 21251 | 8mm Combination Wrench | PLASTIC HANG TAB/LABEL | 200 | 10 |
| 21261 | 9mm Combination Wrench | PLASTIC HANG TAB/LABEL | 200 | 10 |
| 21271 | 10mm Combination Wrench | PLASTIC HANG TAB/LABEL | 200 | 10 |
| 21281 | 11mm Combination Wrench | PLASTIC HANG TAB/LABEL | 200 | 10 |
| 21291 | 12mm Combination Wrench | PLASTIC HANG TAB/LABEL | 200 | 10 |
| 21301 | 13mm Combination Wrench | PLASTIC HANG TAB/LABEL | 200 | 10 |
| 21311 | 14mm Combination Wrench | PLASTIC HANG TAB/LABEL | 200 | 10 |
| 21321 | 15mm Combination Wrench | PLASTIC HANG TAB/LABEL | 100 | 10 |
| 21331 | 16mm Combination Wrench | PLASTIC HANG TAB/LABEL | 100 | 10 |
| 21341 | 17mm Combination Wrench | PLASTIC HANG TAB/LABEL | 100 | 10 |
| 21351 | 18mm Combination Wrench | PLASTIC HANG TAB/LABEL | 100 | 10 |
| 21361 | 19mm Combination Wrench | PLASTIC HANG TAB/LABEL | 100 | 10 |
| 21371 | 20mm Combination Wrench | PLASTIC HANG TAB/LABEL | 50 | 5 |
| 21381 | 21mm Combination Wrench | PLASTIC HANG TAB/LABEL | 50 | 5 |
| 21391 | 22mm Combination Wrench | PLASTIC HANG TAB/LABEL | 50 | 5 |
| 21401 | 23mm Combination Wrench | PLASTIC HANG TAB/LABEL | 50 | 5 |
| 21411 | 24mm Combination Wrench | PLASTIC HANG TAB/LABEL | 50 | 5 |
| 21431 | 1/4" Combination Wrench | PLASTIC HANG TAB/LABEL | 200 | 10 |
| 21441 | 5/16" Combination Wrench | PLASTIC HANG TAB/LABEL | 200 | 10 |
| 21451 | 3/8" Combination Wrench | PLASTIC HANG TAB/LABEL | 200 | 10 |
| 21491 | 7/16" Combination Wrench | PLASTIC HANG TAB/LABEL | 200 | 10 |
| 21501 | 1/2" Combination Wrench | PLASTIC HANG TAB/LABEL | 200 | 10 |
| 21511 | 9/16" Combination Wrench | PLASTIC HANG TAB/LABEL | 200 | 10 |
| 21521 | 5/8" Combination Wrench | PLASTIC HANG TAB/LABEL | 100 | 10 |
| 21531 | 11/16" Combination Wrench | PLASTIC HANG TAB/LABEL | 100 | 10 |
| 21541 | 3/4" Combination Wrench | PLASTIC HANG TAB/LABEL | 100 | 10 |
| 21551 | 13/16" Combination Wrench | PLASTIC HANG TAB/LABEL | 50 | 5 |
| 21561 | 7/8" Combination Wrench | PLASTIC HANG TAB/LABEL | 50 | 5 |
| 21571 | 15/16" Combination Wrench | PLASTIC HANG TAB/LABEL | 50 | 5 |
| 21581 | 1" Combination Wrench | PLASTIC HANG TAB/LABEL | 50 | 5 |
| 21611 | 1-1/16" Combination Wrench | PLASTIC HANG TAB/LABEL | 50 | 5 |
| 21621 | 1-1/8" Combination Wrench | PLASTIC HANG TAB/LABEL | 30 | 5 |
| 21631 | 1-1/4" Combination Wrench | PLASTIC HANG TAB/LABEL | 30 | 5 |



PACKAGING

- Space-Saving Hang Tabs Hold Wrenches Securely and Allow Hands-On Interaction with Product
- Easy-to-Read Size on 4-Color Label
- Lifetime Warranty, Specifications and Barcode on Reverse Side



Individual Jumbo Combination Wrenches

- Drop Forged Heat Treated Carbon Steel
- Corrosion-Resistant Chrome Plated Finish
- 15° Angled Open Ends
- Precision-Machined 12-Point Box Ends
- Raised Panel for Added Strength
- Meets or Exceeds ANSI Specifications

| Item | Description | Packaging | Cs | In |
|-------|-----------------------------------|-----------|----|----|
| 1951 | 1-5/16" Jumbo Combination Wrench | BULK/UPC | 24 | 6 |
| 1952 | 1-3/8" Jumbo Combination Wrench | BULK/UPC | 24 | 6 |
| 1953 | 1-7/16" Jumbo Combination Wrench | BULK/UPC | 24 | 6 |
| 1954 | 1-1/2" Jumbo Combination Wrench | BULK/UPC | 24 | 6 |
| 19558 | 1-3/16" Jumbo Combination Wrench | BULK/UPC | 24 | 6 |
| 19559 | 1-9/16" Jumbo Combination Wrench | BULK/UPC | 12 | 4 |
| 19560 | 1-5/8" Jumbo Combination Wrench | BULK/UPC | 12 | 4 |
| 19561 | 1-11/16" Jumbo Combination Wrench | BULK/UPC | 12 | 4 |
| 19562 | 1-3/4" Jumbo Combination Wrench | BULK/UPC | 12 | 4 |
| 19563 | 1-13/16" Jumbo Combination Wrench | BULK/UPC | 12 | 4 |
| 19564 | 1-7/8" Jumbo Combination Wrench | BULK/UPC | 12 | 4 |
| 19565 | 2" Jumbo Combination Wrench | BULK/UPC | 6 | 2 |
| 19566 | 2-1/8" Jumbo Combination Wrench | BULK/UPC | 6 | 2 |
| 19567 | 2-1/4" Jumbo Combination Wrench | BULK/UPC | 6 | 2 |
| 19568 | 2-3/8" Jumbo Combination Wrench | BULK/UPC | 6 | 2 |
| 19569 | 2-1/2" Jumbo Combination Wrench | BULK/UPC | 6 | 2 |



26 Wrenches



4-pc. Adjustable Wrench Set

- Drop Forged, Heat Treated Carbon Steel
- Corrosion-Resistant Chrome Plated Finish
- Precision-Machined Jaws for Exact Fit and Smooth Adjustment
- Meets or Exceeds ANSI Specifications
- 4-pc. Adjustable Wrenches: 6", 8", 10", 12"
- Complete with Roll-Up Storage Pouch

| Wrench Size | Jaw Opening |
|-------------|-------------|
| 6" | 3/4" |
| 8" | 7/8" |
| 10" | 1-1/4" |
| 12" | 1-3/8" |

| Item | Description | Packaging | Cs | In |
|------|-----------------------------|-----------|----|----|
| 2291 | 4-pc. Adjustable Wrench Set | COLOR BOX | 10 | 1 |



Stubby Adjustable Wrench

- Drop Forged, Heat Treated Steel
- Corrosion-Resistant Chrome Plated Finish
- Comfortable Non-Slip Soft Handle Grip
- Compact Size for Tight Work Areas
- Full Size 1" Jaw Capacity
- Meets or Exceeds ANSI Specifications

| Item | Description | Packaging | Cs | In |
|------|--------------------------|------------------------|----|----|
| 2293 | Stubby Adjustable Wrench | PLASTIC HANG TAB/LABEL | 48 | 6 |

Adjustable Wrenches

- Drop Forged Heat Treated Carbon Steel
- Corrosion-Resistant Chrome Plated Finish
- Precision-Machined Jaws for Exact Fit and Smooth Adjustment
- Comfortable Cushioned Non-Slip Handle Grip
- Meets or Exceeds ANSI Specifications

| Item # | Wrench Size | Jaw Opening |
|--------|-------------|-------------|
| 2294 | 4" | 5/8" |
| 2300 | 6" | 3/4" |
| 2305 | 8" | 1" |
| 2315 | 10" | 1-1/4" |
| 2325 | 12" | 1-1/2" |
| 2330 | 15" | 1-7/8" |



| Item | Description | Packaging | Cs | In |
|------|-----------------------|------------------------|-----|----|
| 2294 | 4" Adjustable Wrench | PLASTIC HANG TAB/LABEL | 100 | 5 |
| 2300 | 6" Adjustable Wrench | PLASTIC HANG TAB/LABEL | 72 | 6 |
| 2305 | 8" Adjustable Wrench | PLASTIC HANG TAB/LABEL | 72 | 6 |
| 2315 | 10" Adjustable Wrench | PLASTIC HANG TAB/LABEL | 60 | 6 |
| 2325 | 12" Adjustable Wrench | PLASTIC HANG TAB/LABEL | 36 | 6 |
| 2330 | 15" Adjustable Wrench | SEALED BLISTER - HALF | 12 | 6 |

Jumbo Adjustable Wrenches

- Drop Forged Carbon Steel
- Heat Treated and Chrome Plated
- Polished Heads
- Smooth Open/Close Roller Action
- Accurate, Precision-Machined Jaws

| Item # | Wrench Size | Jaw Opening |
|--------|-------------|-------------|
| 2340 | 18" | 2-1/4" |
| 2341 | 24" | 2-1/2" |

| Item | Description | Packaging | Cs | In |
|------|-----------------------------|-----------|----|----|
| 2340 | 18" Jumbo Adjustable Wrench | BULK/UPC | 12 | 3 |
| 2341 | 24" Jumbo Adjustable Wrench | BULK/UPC | 6 | 3 |



Aluminum Pipe Wrenches

- Forged and Hardened Jaws and Nut
- Rugged Cast I-Beam Handle
- Spring Loaded Floating Jaw with Aggressive Teeth for Sure Grip
- Aluminum Construction Weighs 30% Less than Steel

2368

- 3-pc. Aluminum Pipe Wrenches: 14", 18", 24"
- Complete with Snap-in Carry Case

| Item # | Wrench Size | Jaw Capacity |
|--------|-------------|--------------|
| 2361 | 14" | 2-3/4" |
| 2362 | 18" | 3-3/8" |
| 2363 | 24" | 4-1/8" |
| 2364 | 36" | 5-1/2" |

| Item | Description | Packaging | Cs | In |
|------|--------------------------------|----------------------|----|----|
| 2361 | 14" Aluminum Pipe Wrench | TIE CARD | 24 | 4 |
| 2362 | 18" Aluminum Pipe Wrench | TIE CARD | 16 | 4 |
| 2363 | 24" Aluminum Pipe Wrench | TIE CARD | 12 | 2 |
| 2364 | 36" Aluminum Pipe Wrench | TIE CARD | 4 | 1 |
| 2368 | 3-pc. Aluminum Pipe Wrench Set | BLOW MOLD TRAY/LABEL | 4 | 1 |



Pipe Wrenches

- Forged and Hardened Jaws and Nut
- Rugged Cast I-Beam Handle
- Spring Loaded Floating Jaw with Aggressive Teeth for Sure Grip

2365

- 4-pc. Pipe Wrenches: 8", 10", 14", 18"

| Item # | Wrench Size | Jaw Capacity |
|--------|-------------|--------------|
| 2370 | 8" | 1-1/2" |
| 2376 | 10" | 1-7/8" |
| 2381 | 14" | 2-1/4" |
| 2386 | 18" | 3-1/8" |

| Item | Description | Packaging | Cs | In |
|------|-----------------------|-----------|----|----|
| 2365 | 4-pc. Pipe Wrench Set | COLOR BOX | 4 | 1 |
| 2370 | 8" Pipe Wrench | TIE CARD | 36 | 6 |
| 2376 | 10" Pipe Wrench | TIE CARD | 24 | 6 |
| 2381 | 14" Pipe Wrench | TIE CARD | 12 | 3 |
| 2386 | 18" Pipe Wrench | TIE CARD | 6 | 2 |



Pipe Wrenches

- Forged and Hardened Jaws and Nut
- Rugged Cast I-Beam Handle
- Non-Slip Cushioned Handle Reduces Fatigue
- Spring Loaded Floating Jaw with Aggressive Teeth for Sure Grip

| Item # | Wrench Size | Jaw Capacity |
|--------|-------------|--------------|
| 2371 | 8" | 1-1/2" |
| 2377 | 10" | 1-7/8" |
| 2382 | 14" | 2-1/4" |
| 2387 | 18" | 3-1/8" |

| Item | Description | Packaging | Cs | In |
|------|-----------------|-----------|----|----|
| 2371 | 8" Pipe Wrench | TIE CARD | 36 | 6 |
| 2377 | 10" Pipe Wrench | TIE CARD | 24 | 6 |
| 2382 | 14" Pipe Wrench | TIE CARD | 18 | 6 |
| 2387 | 18" Pipe Wrench | TIE CARD | 6 | 3 |



Jumbo Pipe Wrenches

- Forged and Hardened Jaws and Nut
- Rugged Cast I-Beam Handle
- Spring Loaded Floating Jaw with Aggressive Teeth for Sure Grip

| Item # | Wrench Size | Jaw Capacity |
|--------|-------------|--------------|
| 2390 | 24" | 3-3/4" |
| 2395 | 24" | 4" |

| Item | Description | Packaging | Cs | In |
|------|-----------------|-----------|----|----|
| 2390 | 24" Pipe Wrench | TIE CARD | 4 | 2 |
| 2395 | 36" Pipe Wrench | TIE CARD | 4 | 2 |





3/8" and 1/2" Dual Drive Torque Wrench

- Drop Forged, Heat Treated Chrome Vanadium Steel Shaft
- 3/8" and 1/2" Dual Drive Head
- Corrosion-Resistant Chrome Plated Finish
- Comfortable Floating Poly Handle
- Precision Needle Point Gauge
- Dual Scale 0-150 Ft./Lbs. and 0-20 Mkp Capacity

| Item | Description | Packaging | Cs | In |
|------|--|-----------------|----|----|
| 2430 | 3/8" and 1/2" Dual Drive Torque Wrench | COLOR HANG CARD | 24 | 6 |



1/4" Drive Click Torque Wrench

- Hardened Alloy Steel Handle
- Reversible Drive, Forged Chrome Vanadium Steel Ratchet Head
- Corrosion-Resistant Chrome Plated Finish
- Locking Micrometer Torque Adjustment with Non-Slip Knurled Grip
- Wrench Clicks when Torque Setting is Reached
- Meets or Exceeds Federal Specification GGG-W00686C

Specifications:

- Ratchet: CR-V, 24 Tooth
- Length: 10"
- Dual Range: 20-200 inch/lbs. / 23-230 cm/kg
- Increment: 1 inch/lb. / 0.53 cm/kg
- Calibration: +/- 4%
- 1-pc. 1/4" Drive Torque Wrench
- 1-pc. Storage Case
- Instruction Sheet / Torque Conversion Chart

| Item | Description | Packaging | Cs | In |
|------|--------------------------------|-----------|----|----|
| 2432 | 1/4" Drive Click Torque Wrench | COLOR BOX | 20 | 5 |

3/8" Drive Click Torque Wrench

- Hardened Alloy Steel Handle
- Reversible Drive, Forged Chrome Vanadium Steel Ratchet Head
- Corrosion-Resistant Chrome Plated Finish
- Locking Micrometer Torque Adjustment with Non-Slip Knurled Grip
- Wrench Clicks when Torque Setting is Reached
- Meets or Exceeds Federal Specification GGG-W00686C

Specifications:

- Ratchet: CR-V, 44 Tooth
- Length: 10"
- Dual Range: 120-960 inch/lbs. / 1.4-11.1 m/kg
- Increment: 12 inch/lb. / 0.14 m/kg
- Calibration: +/- 4%

| Item | Description | Packaging | Cs | In |
|------|--------------------------------|--------------------|----|----|
| 2435 | 3/8" Drive Click Torque Wrench | SLIDE BLISTER CARD | 20 | 5 |

3/8" Drive Click Torque Wrench

- Hardened Alloy Steel Handle
- Reversible Drive, Forged Chrome Vanadium Steel Ratchet Head
- Corrosion-Resistant Chrome Plated Finish
- Locking Micrometer Torque Adjustment with Non-Slip Knurled Grip
- Wrench Clicks when Torque Setting is Reached
- Meets or Exceeds Federal Specification GGG-W00686C

Specifications:

- Ratchet: CR-V, 45 Tooth
- Length: 10"
- Dual Range: 120-960 inch/lbs. / 1.4-11.1 m/kg
- Increment: 12 inch/lb. / 0.14 m/kg
- Calibration: +/- 4%
- 1-pc. 3/8" Drive Torque Wrench
- 1-pc. 3/8" Dr. (F) x 1/2 Dr. (M) Adapter
- 1-pc. Storage Case
- Instruction Sheet / Torque Conversion Chart

| Item | Description | Packaging | Cs | In |
|------|--------------------------------|-----------|----|----|
| 2455 | 3/8" Drive Click Torque Wrench | COLOR BOX | 20 | 5 |



1/2" Drive Click Torque Wrench

- Hardened Alloy Steel Handle
- Reversible Drive, Forged Chrome Vanadium Steel Ratchet Head
- Corrosion-Resistant Chrome Plated Finish
- Locking Micrometer Torque Adjustment with Non-Slip Knurled Grip
- Wrench Clicks when Torque Setting is Reached
- Meets or Exceeds Federal Specification GGG-W00686C

Specifications:

- Ratchet: CR-V, 24 Tooth
- Length: 18"
- Dual Range: 20-150 ft./lbs. / 2.8-20.7 m/kg
- Increment: 1 ft./lb. / 0.14 m/kg
- Calibration: +/- 4%

| Item | Description | Packaging | Cs | In |
|------|--------------------------------|--------------------|----|----|
| 2440 | 1/2" Drive Click Torque Wrench | SLIDE BLISTER CARD | 12 | 6 |



1/2" Drive Click Torque Wrench

- Hardened Alloy Steel Handle
- Reversible Drive, Forged Chrome Vanadium Steel Ratchet Head
- Corrosion-Resistant Chrome Plated Finish
- Locking Micrometer Torque Adjustment with Non-Slip Knurled Grip
- Wrench Clicks when Torque Setting is Reached
- Meets or Exceeds Federal Specification GGG-W00686C

Specifications:

- Ratchet: CR-V, 24 Tooth
- Length: 18"
- Dual Range: 20-150 ft./lbs. / 2.8-20.7 m/kg
- Increment: 1 ft./lb. / 0.14 m/kg
- Calibration: +/- 4%
- 1-pc. 1/2" Drive Torque Wrench
- 1-pc. 1/2" Dr. (F) x 3/8" Dr. (M) Reducer
- 1-pc. 1/2" Dr. 5" Extension Bar
- 1-pc. Storage Case
- Instruction Sheet / Torque Conversion Chart

| Item | Description | Packaging | Cs | In |
|------|--------------------------------|-----------|----|----|
| 2460 | 1/2" Drive Click Torque Wrench | COLOR BOX | 12 | 1 |



1/2" Drive Click Torque Wrench (250 ft.-lb.)

- Hardened Alloy Steel Handle
- Reversible Drive, Forged Chrome Vanadium Steel Ratchet Head
- Corrosion-Resistant Chrome Plated Finish
- Locking Micrometer Torque Adjustment with Non-Slip Knurled Grip
- Wrench Clicks when Torque Setting is Reached
- Meets or Exceeds Federal Specification GGG-W00686C

Specifications:

- Ratchet: CR-V, 24 Tooth
- Length: 24"
- Dual Range: 25-250 ft./lbs. / 3.5-34.5 m/kg
- Increment: 1 ft./lb. / 0.14 m/kg
- Calibration: +/- 4%

| Item | Description | Packaging | Cs | In |
|------|--|-----------|----|----|
| 2445 | 1/2" Drive Click Torque Wrench (250 ft.-lb.) | COLOR BOX | 10 | 10 |



Crowfoot Wrench Sets

- Drop Forged, Heat Treated Carbon Steel Construction
- Corrosion-Resistant Chrome Plated Finish

2575

- 10-pc. 3/8" Dr. Crowfoot Wrenches (SAE): 3/8", 7/16", 1/2", 9/16", 5/8", 11/16", 3/4", 13/16", 7/8", 1"
- Includes Hanging Storage Rail

2580

- 10-pc. 3/8" Dr. Crowfoot Wrenches (Metric): 10, 11, 13, 14, 15, 17, 19, 21, 22, 24mm
- Includes Hanging Storage Rail

2585

- 14-pc. 1/2" Dr. Crowfoot Wrenches (SAE): 1-1/16", 1-1/18", 1-3/16", 1-1/4", 1-5/6", 1-3/8", 1-7/16", 1-1/2", 1-5/8", 1-11/16", 1-3/4", 1-13/16", 1-7/8", 2"
- Complete with Snap-in Storage Tray

| Item | Description | Packaging | Cs | In |
|------|---|--------------------|----|----|
| 2575 | 10-pc. 3/8" Drive Crowfoot Wrench Set (SAE) | SLIDE BLISTER CARD | 30 | 6 |
| 2580 | 10-pc. 3/8" Drive Crowfoot Wrench Set (Metric) | SLIDE BLISTER CARD | 30 | 6 |
| 2585 | 14-pc. 1/2" Drive Jumbo Crowfoot Wrench Set (SAE) | COLOR BOX | 4 | 1 |



2575 / 2580



2585

Folding Hex Key Wrench Sets



- 25151**
- 9-pc. Hex (SAE): 5/64, 3/32, 7/64, 1/8, 9/64, 5/32, 3/16, 7/32, 1/4"
- 25161**
- 8-pc. Hex (Metric): 1.5, 2, 2.5, 3, 4, 5, 6, 8mm

- Rugged, Black Oxide Finished Chrome Vanadium Steel Wrenches
- Heavy Duty Color-Coded Housing
- Textured Non-Slip Grips

Folding Star Key Wrench Sets



- 25171**
- 8-pc. Star (SAE): SD-9, SD-10, SD-15, SD-20, SD-25, SD-27, SD-30, SD-40
- 2520**
- 9-pc. Hex (SAE): 5/64, 3/32, 7/64, 1/8, 9/64, 5/32, 3/16, 7/32, 1/4"
 - 2-pc. Star: SD-15, SD-20

| Item | Description | Packaging | Cs | In |
|-------|--|----------------------|----|----|
| 25151 | 9-pc. Folding Hex Key Wrench Set (SAE) | COLOR POLY HANG CARD | 24 | 4 |
| 25161 | 8-pc. Folding Hex Key Wrench Set (Metric) | COLOR POLY HANG CARD | 24 | 4 |
| 25171 | 8-pc. Folding Star Key Wrench Set | COLOR POLY HANG CARD | 24 | 4 |
| 2520 | 11-pc. Folding Hex and Star Key Wrench Clip | COLOR POLY HANG CARD | 36 | 6 |
| 25181 | 9-pc. Folding Ball Hex Key Wrench Set (SAE) | COLOR POLY HANG CARD | 24 | 4 |
| 25191 | 8-pc. Folding Ball Hex Key Wrench Set (Metric) | COLOR POLY HANG CARD | 24 | 4 |

Folding Ball Hex Key Wrench Sets



- Ball Hex Ends Allow up to a 25° Offset for Easy Access to Fasteners
- 25181**
- 9-pc. Ball Hex (SAE): 5/64, 3/32, 7/64, 1/8, 9/64, 5/32, 3/16, 7/32, 1/4"
- 25191**
- 8-pc. Ball Hex (MM): 1.5, 2, 2.5, 3, 4, 5, 6, 8mm

13-pc. Short Arm Hex Key Wrench Sets



- Short Arm Wrenches Access Fasteners in Tight Spaces

- 25211**
- 13-pc. Short Arm (SAE): .05, 1/16, 5/64, 3/32, 7/64, 1/8, 9/64, 5/32, 3/16, 7/32, 1/4, 5/16, 3/8"
- 25212**
- 13-pc. Short Arm (MM): 1.27, 1.5, 2, 2.5, 3, 3.5, 4, 4.5, 5, 5.5, 6, 8, 10mm

- Rugged, Black Oxide Finished Chrome Vanadium Steel Wrenches
- Color-Coded Storage Case Keeps Wrenches Organized
- Short Arm Wrenches Access Fasteners in Tight Spaces

9-pc. Long Arm Hex Key Wrench Sets

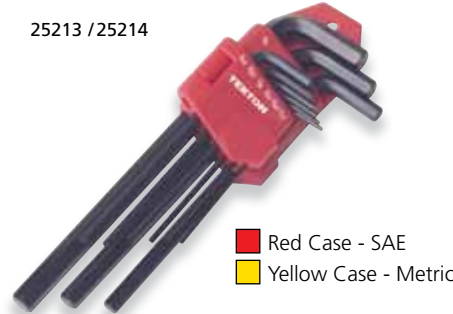

- Long Arm Wrenches for Extra Reach and Greater Torque

- 25213**
- 9-pc. (SAE): 1/16, 5/64, 3/32, 1/8, 5/32, 3/16, 1/4, 5/16, 3/8"
- 25214**
- 9-pc. (MM): 1.5, 2, 2.5, 3, 4, 5, 6, 8, 10mm

| Item | Description | Packaging | Cs | In |
|-------|--|--------------------|----|----|
| 25211 | 13-pc. Short Arm Hex Key Wrench Set (SAE) | SLIDE BLISTER CARD | 48 | 4 |
| 25212 | 13-pc. Short Arm Hex Key Wrench Set (Metric) | SLIDE BLISTER CARD | 48 | 4 |
| 25213 | 9-pc. Long Arm Hex Key Wrench Set (SAE) | SLIDE BLISTER CARD | 24 | 4 |
| 25214 | 9-pc. Long Arm Hex Key Wrench Set (Metric) | SLIDE BLISTER CARD | 24 | 4 |
| 25217 | 13-pc. Long Arm Hex Key Wrench Set (SAE) | SLIDE BLISTER CARD | 24 | 4 |
| 25218 | 13-pc. Long Arm Hex Key Wrench Set (Metric) | SLIDE BLISTER CARD | 24 | 4 |

13-pc. Long Arm Hex Key Wrench Sets



- 25217**
- 13-pc. Long Arm (SAE): .05, 1/16, 5/64, 3/32, 7/64, 1/8, 9/64, 5/32, 3/16, 7/32, 1/4, 5/16, 3/8"
- 25218**
- 13-pc. Long Arm (MM): 1.27, 1.5, 2, 2.5, 3, 3.5, 4, 4.5, 5, 5.5, 6, 8, 10mm

9-pc. Long Arm Ball Hex Key Wrench Sets

25215 / 25216



- Red Case - SAE
- Yellow Case - Metric

- Ball Hex Ends Allow up to a 25° Offset for Easy Access to Fasteners

25215

- 9-pc. (SAE): 1/16, 5/64, 3/32, 1/8, 5/32, 3/16, 1/4, 5/16, 3/8"

25216

- 9-pc. (MM): 1.5, 2, 2.5, 3, 4, 5, 6, 8, 10mm

- Rugged, Black Oxide Finished Chrome Vanadium Steel Wrenches
- Color-Coded Storage Case Keeps Wrenches Organized
- Long Arm Wrenches for Extra Reach and Greater Torque
- Ball Hex Ends Allow up to a 25° Offset for Easy Access to Fasteners

13-pc. Long Arm Ball Hex Key Wrench Sets

25219 / 25220



- Red Case - SAE
- Yellow Case - Metric

- Long Arm Wrenches for Extra Reach and Greater Torque

25219

- 13-pc. (SAE): .05, 1/16, 5/64, 3/32, 7/64, 1/8, 9/64, 5/32, 3/16, 7/32, 1/4, 5/16, 3/8"

25220

- 13-pc. (MM): 1.27, 1.5, 2, 2.5, 3, 3.5, 4, 4.5, 5, 5.5, 6, 8, 10mm

| Item | Description | Packaging | Cs | In |
|-------|--|--------------------|----|----|
| 25215 | 9-pc. Long Arm Ball Hex Key Wrench Set (SAE) | SLIDE BLISTER CARD | 24 | 4 |
| 25216 | 9-pc. Long Arm Ball Hex Key Wrench Set (Metric) | SLIDE BLISTER CARD | 24 | 4 |
| 25219 | 13-pc. Long Arm Ball Hex Key Wrench Set (SAE) | SLIDE BLISTER CARD | 24 | 4 |
| 25220 | 13-pc. Long Arm Ball Hex Key Wrench Set (Metric) | SLIDE BLISTER CARD | 24 | 4 |



22-pc. Long Arm Hex Key Wrench Set (SAE/Metric)

- Rugged, Black Oxide Finished Chrome Vanadium Steel Wrenches
- Color-Coded Storage Cases Keep Wrenches Organized
- Long Arm Wrenches for Extra Reach and Greater Torque
- 13-pc. Hex Key Wrenches (SAE): .05, 1/16, 5/64, 3/32, 7/64, 1/8, 9/64, 5/32, 3/16, 7/32, 1/4, 5/16, 3/8"
- 9-pc. Hex Key Wrenches (Metric): 1.5, 2, 2.5, 3, 4, 5, 6, 8, 10mm

| Item | Description | Packaging | Cs | In |
|-------|---|-----------------------|----|----|
| 25221 | 22-pc. Long Arm Hex Key Wrench Set (SAE/Metric) | SEALED BLISTER - FULL | 24 | 3 |



25-pc. Folding Hex Key Wrench Set (SAE/Metric/Star)

- Rugged, Black Oxide Finished Chrome Vanadium Steel Wrenches
- Heavy Duty Color-Coded Housings
- Textured Non-Slip Rubberized Grips
- 9-pc. Hex Key Wrenches (SAE): 5/64", 3/32", 7/64", 1/8", 9/64", 5/32", 3/16", 7/32", 1/4"
- 8-pc. Hex Key Wrenches (Metric): 1.5, 2, 2.5, 3, 4, 5, 6, 8mm
- 8-pc. Star Key Wrenches: SD-9, 10, 15, 20, 25, 27, 30, 40

| Item | Description | Packaging | Cs | In |
|-------|---|----------------------|----|----|
| 25222 | 25-pc. Folding Hex Key Wrench Set (SAE/Metric/Star) | COLOR POLY HANG CARD | 24 | 6 |

32 Wrenches



Key Ring Hex Key Wrench Sets

2485 / 2490

- Heat Treated Carbon Steel Construction
- Black Oxide Finish Resists Corrosion
- Key Ring Organizer with Removable Spring Wrench Retainers

2485

- 8-pc. Hex Key Wrenches: SAE - 1/16, 5/64, 3/32, 1/8, 5/32, 3/16, 7/32, 1/4"

2490

- 8-pc. Hex Key Wrenches: Metric - 1.5, 2, 2.5, 3, 4, 5, 5.5, 6mm

2500

- Heat Treated Carbon Steel Construction
- Chrome Plated (SAE) and Black Oxide (Metric) Finishes Resist Corrosion
- Key Ring Organizer with Removable Spring Wrench Retainers

- 7-pc. Hex Key Wrenches (SAE): - 1/16", 5/64", 3/32", 1/8", 5/32", 3/16", 7/32"

- 7-pc. Hex Key Wrenches (Metric): - 1.5, 2, 2.5, 3, 4, 5.5, 6mm

| Item | Description | Packaging | Cs | In |
|------|--|--------------|----|----|
| 2485 | 8-pc. Hex Key Wrench Set (SAE) | BLISTER CARD | 72 | 12 |
| 2490 | 8-pc. Hex Key Wrench Set (Metric) | BLISTER CARD | 72 | 12 |
| 2500 | 14-pc. Hex Key Wrench Set (SAE/Metric) | BLISTER CARD | 72 | 12 |



2512

2513

25-pc. Hex Key Wrench Sets

2512

- Heat Treated Carbon Steel Construction
- Black Oxide Finish Resists Corrosion
- Long Arm SAE Sizes and Short Arm Metric Sizes

- 12-pc. Long Arm (SAE): 0.05, 1/16, 5/64, 3/32, 7/64, 1/8, 9/64, 5/32, 3/16, 7/32, 1/4, 5/16, 3/8"

- 13-pc. Short Arm (Metric): 1.3, 1.5, 2, 2.5, 3, 4, 5, 5.5, 6, 7, 8, 10mm
- Complete with Storage/Organizer Pouch

2513

- Hardened and Tempered Chrome Vanadium Steel
- Black Oxide Finish Resists Corrosion
- Long Arm SAE Sizes and Short Arm Metric Sizes

- 12-pc. Long Arm (SAE): 1/16, 5/64, 3/32, 7/64, 1/8, 9/64, 5/32, 3/16, 7/32, 1/4, 5/16, 3/8"

- 13-pc. Short Arm (Metric): 1.5, 2, 2.5, 3, 4, 4.5, 5, 5.5, 6, 7, 8, 9, 10mm
- Complete with Storage/Organizer Pouch

| Item | Description | Packaging | Cs | In |
|------|--|-----------------------|----|----|
| 2512 | 25-pc. Hex Key Wrench Set (SAE/Metric) | POUCH/COLOR LABEL | 20 | 10 |
| 2513 | 25-pc. Hex Key Wrench Set (SAE/Metric) | SEALED BLISTER - FULL | 24 | 6 |



6-pc. Jumbo Hex Key Wrench Sets

- Heat Treated Chrome Vanadium Steel
- Black Oxide Finish Resists Corrosion

2535

- 6-pc. Wrenches (SAE): 3/8", 7/16", 1/2", 9/16", 5/8", 3/4"
- Complete with Snap-in Carry Case

2540

- 6-pc. Wrenches (Metric): 8, 10, 12, 14, 17, 19mm
- Complete with Snap-in Carry Case

| Item | Description | Packaging | Cs | In |
|------|---|----------------------|----|----|
| 2535 | 6-pc. Jumbo Hex Key Wrench Set (SAE) | BLOW MOLD TRAY/LABEL | 12 | 3 |
| 2540 | 6-pc. Jumbo Hex Key Wrench Set (Metric) | BLOW MOLD TRAY/LABEL | 12 | 3 |



10-pc. T-Handle Hex Key Wrench Sets

- Heat Treated Extruded Alloy Steel
- Black Oxide Finish for Durability
- Contoured Plastic T-Handles
- T-Handle Design Increases Turning Power and Provides a Sure Comfortable Grip
- Color Coded Handles for Easy Size Selection

2546

- 10-pc. Wrenches (SAE): 3/32", 7/64", 1/8", 9/64", 5/32", 3/16", 7/32", 1/4", 5/16", 3/8"
- Complete with Handy Steel Index Stand

2547

- 10-pc. Wrenches (Metric): 2, 2.5, 3, 4, 4.5, 5, 5.5, 6, 8, 10mm
- Complete with Handy Steel Index Stand

| Item | Description | Packaging | Cs | In |
|------|---|-----------------------|----|----|
| 2546 | 10-pc. T-Handle Hex Key Wrench Set (SAE) | SEALED BLISTER - FULL | 12 | 6 |
| 2547 | 10-pc. T-Handle Hex Key Wrench Set (Metric) | SEALED BLISTER - FULL | 12 | 6 |

3-pc. Flare Nut Wrench Sets

- Drop Forged, Heat Treated Carbon Steel Construction
- Corrosion-Resistant Chrome Plated Finish
- 15-Degree Offset Ends
- Use for Connection Fittings on Fuel, Brake, and Air Conditioning Lines
- Meets or Exceeds ANSI Standards

2640

- 3-pc. Wrenches (SAE): 3/8" x 7/16", 1/2" x 9/16", 5/8" x 11/16"

2645

- 3-pc. Wrenches (Metric): 10 x 12, 13 x 14, 15 x 17mm



| Item | Description | Packaging | Cs | In |
|------|-------------------------------------|--------------------|----|----|
| 2640 | 3-pc. Flare Nut Wrench Set (SAE) | SLIDE BLISTER CARD | 50 | 5 |
| 2645 | 3-pc. Flare Nut Wrench Set (Metric) | SLIDE BLISTER CARD | 50 | 5 |

6-pc. Flare Nut Wrench Sets

- Drop Forged, Heat Treated Carbon Steel Construction
- Corrosion-Resistant Chrome Plated Finish
- 15-Degree Offset Ends
- Use for Connection Fittings on Fuel, Brake, and Air Conditioning Lines
- Meets or Exceeds ANSI Standards

2650

- 6-pc. Wrenches (SAE): 1/4" x 5/16", 3/8" x 7/16", 1/2" x 9/16", 5/8" x 11/16", 3/4" x 13/16", 7/8" x 1"

2655

- 6-pc. Wrenches (Metric): 6 x 8, 10 x 12, 13 x 14, 15 x 17, 19 x 21, 22 x 24mm



| Item | Description | Packaging | Cs | In |
|------|-------------------------------------|--------------------|----|----|
| 2650 | 6-pc. Flare Nut Wrench Set (SAE) | SLIDE BLISTER CARD | 20 | 5 |
| 2655 | 6-pc. Flare Nut Wrench Set (Metric) | SLIDE BLISTER CARD | 20 | 5 |



12" Basin Wrench

- Hardened Steel Jaws with Aggressive Teeth
- Chrome Plated Finish Resists Corrosion
- Spring-Loaded Swivel Jaw Automatically Adjusts to Size to Grip Hard-to-Reach Fittings
- Sliding T-Handle

| Item | Description | Packaging | Cs | In |
|------|------------------|-----------------|----|----|
| 2672 | 12" Basin Wrench | COLOR HANG CARD | 40 | 10 |



12-pc. Wrench Holder

- Twelve Spring-Loaded Slots Securely Hold Wrenches While Organizer is Carried
- Heat Treated Steel with Chip Resistant Finish
- Comfortable Cushioned Carry Handle
- Complete with Holes for Mounting on Wall or Workbench

| Item | Description | Packaging | Cs | In |
|------|----------------------|--------------|----|----|
| 2685 | 12-pc. Wrench Holder | COLOR SLEEVE | 72 | 6 |

34 Screwdrivers



22-pc. Mechanic's Screwdriver Set

- Hardened and Tempered Chrome Vanadium Steel Shafts
- Corrosion-Resistant Chrome Plated Finish
- Precision-Machined, Vapor Blasted Magnetized Tips
- Comfortable, High-Torque Square Handles
- Hex Bolster for Wrench-Assisted Torque (on Most Sizes)
- 10-pc. Flat: 1/8" x 3", 5/32" x 4", 5/32" x 4" w/ Screw Holder, 3/16" x 4", 3/16" x 6", 1/4" x 1-1/2", 1/4" x 4", 1/4" x 6", 5/16" x 8", 3/8" x 10"
- 5-pc. Star Drive: SD-10, SD-15, SD-20, SD-25, SD-30
- 5-pc. Phillips: #0 x 3", #1 x 3", #2 x 1-1/2", #2 x 4", #3 x 6"
- 1-pc. Scratch Awl
- 1-pc. Tack Puller

| Item | Description | Packaging | Cs | In |
|------|-----------------------------------|--------------|----|----|
| 2759 | 22-pc. Mechanic's Screwdriver Set | BLISTER CARD | 10 | 1 |



2-pc. Mechanic's Screwdriver Set

- Hardened and Tempered Carbon Steel Shafts
- Durable Chrome Plated Finish Resists Corrosion
- Precision-Machined Vapor Blasted Magnetized Tips
- Comfortable Mechanic's-Style Handles
- 1-pc. Flat: 1/4" x 4"
- 1-pc. Phillips: #2 x 4"

| Item | Description | Packaging | Cs | In |
|------|----------------------------------|--------------------|----|----|
| 2762 | 2-pc. Mechanic's Screwdriver Set | SLIDE BLISTER CARD | 72 | 12 |



4-pc. Mechanic's Screwdriver Set

- Hardened and Tempered Carbon Steel Shafts
- Durable Chrome Plated Finish Resists Corrosion
- Precision-Machined Vapor Blasted Magnetized Tips
- Comfortable Mechanic's-Style Handles
- 2-pc. Flat: 3/16" x 3", 1/4" x 4"
- 2-pc. Phillips: #1 x 3", #2 x 4"

| Item | Description | Packaging | Cs | In |
|------|----------------------------------|--------------------|----|----|
| 2763 | 4-pc. Mechanic's Screwdriver Set | SLIDE BLISTER CARD | 72 | 12 |



5-pc. Mechanic's Screwdriver Set

- Hardened and Tempered Carbon Steel Shafts
- Durable Chrome Plated Finish Resists Corrosion
- Precision-Machined Vapor Blasted Magnetized Tips
- Comfortable Mechanic's-Style Handles
- Hex Bolster for Wrench-Assisted Torque (on Most Sizes)
- 3-pc. Flat: 3/16" x 3", 1/4" x 4", 5/16" x 6"
- 2-pc. Phillips: #1 x 3", #2 x 4"

| Item | Description | Packaging | Cs | In |
|------|----------------------------------|--------------------|----|----|
| 2764 | 5-pc. Mechanic's Screwdriver Set | SLIDE BLISTER CARD | 40 | 5 |



2-pc. Screw Holding Screwdriver Set

- Hardened and Tempered Chrome Vanadium Steel Shafts
- Durable Chrome Plated Finish
- Precision-Machined Tips
- Square Mechanic's-Style Handles
- Spring-Loaded Jaws Grip Screw Allowing One Hand to Position Workpiece
- 1-pc. Flat: 5/32" x 4"
- 1-pc. Phillips: #1 x 4"

| Item | Description | Packaging | Cs | In |
|------|-------------------------------------|--------------------|-----|----|
| 2800 | 2-pc. Screw Holding Screwdriver Set | SLIDE BLISTER CARD | 100 | 10 |



Star Drive Screwdriver Sets

- Hardened and Tempered Chrome Vanadium Steel Shafts
- Durable Chrome Plated Finish Resists Corrosion
- Precision-Machined Vapor Blasted and Magnetized Tips
- Comfortable Mechanic's-Style Handles

2950

- 2-pc. Star Drive Screwdrivers: SD-15, SD-20

2956

- 6-pc. Star Drive Screwdrivers: SD-10, SD-15, SD-20, SD-25, SD-27, SD-30
- Complete with Storage Rack and Mounting Screws

| Item | Description | Packaging | Cs | In |
|------|----------------------------------|------------------------|----|----|
| 2950 | 2-pc. Star Drive Screwdriver Set | PLASTIC HANG TAB/LABEL | 72 | 12 |
| 2956 | 6-pc. Star Drive Screwdriver Set | SLIDE BLISTER CARD | 24 | 6 |



6-pc. Mechanic's Screwdriver Set

- Hardened and Tempered Carbon Steel Shafts
- Durable Chrome Plated Finish Resists Corrosion
- Precision-Machined Vapor Blasted Magnetized Tips
- Comfortable Mechanic's-Style Handles
- Hex Bolster for Wrench-Assisted Torque (on Most Sizes)

- 4-pc. Flat: 3/16" x 3", 1/4" x 4", 5/16" x 6", 3/8" x 8"
- 2-pc. Phillips: #1 x 3", #2 x 4"

| Item | Description | Packaging | Cs | In |
|------|----------------------------------|--------------------|----|----|
| 2735 | 6-pc. Mechanic's Screwdriver Set | SLIDE BLISTER CARD | 24 | 6 |



8-pc. Mechanic's Screwdriver Set

- Hardened and Tempered Carbon Steel Shafts
- Durable Chrome Plated Finish Resists Corrosion
- Precision-Machined Vapor Blasted Magnetized Tips
- Comfortable Mechanic's-Style Handles
- Hex Bolster for Wrench-Assisted Torque (on Most Sizes)

- 5-pc. Flat: 1/4" x 1-1/2", 3/16" x 3", 1/4" x 4", 5/16" x 6", 3/8" x 8"
- 3-pc. Phillips: #2 x 1-1/2", #1 x 3", #2 x 4"

| Item | Description | Packaging | Cs | In |
|------|----------------------------------|-----------------------|----|----|
| 2757 | 8-pc. Mechanic's Screwdriver Set | SEALED BLISTER - FULL | 20 | 5 |

36 Screwdrivers



2767

Pro Screwdriver Sets

2767

- Hardened Chrome Vanadium Steel Shafts
- Magnetized Tips Prevent Dropped Fasteners
- Corrosion-Resistant Chrome Plated Finish
- Comfortable Non-Slip Soft Grip Triple Torque™ Handles
- Ready-to-Mount Workbench Storage Rack

- Flat: 1/4" Stubby, 3/16" x 3", 1/4" x 4"
- Phillips: #2 Stubby, #1 x 3", #2 x 4"

2768

- Hardened Chrome Vanadium Steel Shafts
- Corrosion-Resistant Chrome Plated Finish
- Comfortable Non-Slip Soft Grip Triple Torque™ Handles
- Precision-Milled Sandblasted Chrome Vanadium Steel 1/4" Drive Hex Bits

- 5-pc. Flat: 1/4" x 1-1/2", 1/8" x 3", 3/16" x 3", 1/4" x 4", 5/16" x 6"
- 5-pc. Phillips: #2 x 1-1/2", #0 x 3", #1 x 3", #2 x 4", #3 x 6"
- 2-pc. Precision Flat: 1/8" x 2", 3/32" x 2"
- 3-pc. Precision Phillips: #1 x 2", #0 x 2", #00 x 2"
- 1-pc. Tool Magnetizer/Demagnetizer
- 1-pc. Bit Driver
- 10-pc. 1" (1/4" Drive) Hex Bits: Flat: 5/32", 3/16", 1/4", 9/32"; Phillips: PH#0, PH#1, PH#2, PH#3; Star: SD-10, SD-20
- Complete with Bit Organizer Case



2768

| Item | Description | Packaging | Cs | In |
|------|----------------------------|-----------------------|----|----|
| 2767 | 6-pc. Pro Screwdriver Set | SEALED BLISTER - FULL | 24 | 6 |
| 2768 | 27-pc. Pro Screwdriver Set | SEALED BLISTER - FULL | 10 | 1 |

4-pc. Pro Screwdriver Set



27040

- 2-pc. Flat: 3/16" x 3", 1/4" x 4"
- 2-pc. Phillips: #1 x 3", #2 x 4"

8-pc. Pro Screwdriver Set



27041

- 4-pc. Flat: 3/16" x 3", 1/4" Stubby, 1/4" x 4", 1/4" x 6"
- 4-pc. Phillips: #1 x 3", #2 Stubby, #2 x 4", #2 x 6"

16-pc. Pro Screwdriver Set



27042

- 7-pc. Flat: 1/8" x 3" Pocket, 3/16" x 3", 3/16" x 4", 1/4" x 4", 1/4" x 6", 5/16" x 6", 1/4" Stubby
- 6-pc. Phillips: #0 x 3" Pocket, #1 x 3", #2 Stubby, #2 x 4", #2 x 6", #3 x 6"
- 3-pc. Specialty: #1 Ph. x 3/16" Flat Offset, #2 Ph. x 1/4" Flat Offset, 4-Way Flat Keychain Screwdriver

- Rugged Professional-Grade Chrome Molybdenum Steel
- 6-Flute Handle Design Provides Maximum Grip and Torque
- Triple Chrome-Plated Shafts and Blades Resist Corrosion
- Accurately Machined Tips for Precise Fit in Fasteners
- Magnetized Tips Help Prevent Dropped Fasteners

| Item | Description | Packaging | Cs | In |
|-------|----------------------------|-----------------------|----|----|
| 27040 | 4-pc. Pro Screwdriver Set | SEALED BLISTER - FULL | 40 | 4 |
| 27041 | 8-pc. Pro Screwdriver Set | SEALED BLISTER - FULL | 24 | 6 |
| 27042 | 16-pc. Pro Screwdriver Set | SEALED BLISTER - FULL | 12 | 6 |

Professional Screwdrivers

- Vapor Blasted Magnetized Tips
- Ribbed Tips Increase Grip on Fastener and Reduce Cam-Out (Flat Sizes)
- Oversized 6-Flute Contoured Handles for Sure Grip
- Hardened and Tempered Chrome Molybdenum Steel Shafts are Triple Chrome Plated for Extra Durability

Additional Tip Types Available in the Professional Series



Packaging

- Space-Saving Hang Tabs Hold Screwdrivers Securely and Allow Customers Hands-On Interaction with Product
- Easy-to-Read Size, Style, and Specifications on 4-Color Label
- Lifetime Warranty and Barcode on Reverse Side



| Item | Description | Packaging | Cs | In |
|-------|---------------------------------------|------------------------|----|----|
| 27000 | 1/4" Flat Pro Stubby Screwdriver | PLASTIC HANG TAB/LABEL | 72 | 6 |
| 27001 | 1/8" x 3-1/2" Flat Pocket Screwdriver | PLASTIC HANG TAB/LABEL | 72 | 6 |
| 27002 | 1/8" Flat x 3" Pro Screwdriver | PLASTIC HANG TAB/LABEL | 72 | 6 |
| 27003 | 3/16" Flat x 3" Pro Screwdriver | PLASTIC HANG TAB/LABEL | 72 | 6 |
| 27004 | 3/16" Flat x 4" Pro Screwdriver | PLASTIC HANG TAB/LABEL | 72 | 6 |
| 27005 | 1/4" Flat x 4" Pro Screwdriver | PLASTIC HANG TAB/LABEL | 72 | 6 |
| 27006 | 3/16" Flat x 6" Pro Screwdriver | PLASTIC HANG TAB/LABEL | 72 | 6 |
| 27007 | 1/4" Flat x 6" Pro Screwdriver | PLASTIC HANG TAB/LABEL | 72 | 6 |
| 27008 | 5/16" Flat x 6" Pro Screwdriver | PLASTIC HANG TAB/LABEL | 72 | 6 |
| 27009 | 3/16" Flat x 8" Pro Screwdriver | PLASTIC HANG TAB/LABEL | 72 | 6 |
| 27010 | 3/8" Flat x 8" Pro Screwdriver | PLASTIC HANG TAB/LABEL | 72 | 6 |
| 27011 | 3/16" Flat x 10" Pro Screwdriver | PLASTIC HANG TAB/LABEL | 72 | 6 |
| 27012 | #2 Ph Stubby Pro Screwdriver | PLASTIC HANG TAB/LABEL | 72 | 6 |
| 27013 | #0 Ph x 3" Pro Screwdriver | PLASTIC HANG TAB/LABEL | 72 | 6 |
| 27014 | #1 Ph x 3" Pro Screwdriver | PLASTIC HANG TAB/LABEL | 72 | 6 |
| 27015 | #2 Ph x 4" Pro Screwdriver | PLASTIC HANG TAB/LABEL | 72 | 6 |
| 27016 | #1 Ph x 6" Pro Screwdriver | PLASTIC HANG TAB/LABEL | 72 | 6 |
| 27017 | #2 Ph x 6" Pro Screwdriver | PLASTIC HANG TAB/LABEL | 72 | 6 |
| 27018 | #3 Ph x 6" Pro Screwdriver | PLASTIC HANG TAB/LABEL | 72 | 6 |
| 27022 | #1 Robertson x 4" Pro Screwdriver | PLASTIC HANG TAB/LABEL | 72 | 6 |
| 27023 | #2 Robertson x 4" Pro Screwdriver | PLASTIC HANG TAB/LABEL | 72 | 6 |
| 27024 | #3 Robertson x 4" Pro Screwdriver | PLASTIC HANG TAB/LABEL | 72 | 6 |
| 27030 | 4" Professional Scratch Awl | PLASTIC HANG TAB/LABEL | 72 | 6 |
| 27031 | 4" Professional Tack Puller | PLASTIC HANG TAB/LABEL | 72 | 6 |



4-pc. Mini Screwdriver Set

- Sandblasted Chrome Vanadium Steel
- Precision-Machined Tips for Exact Fit
- 6-Flute Handles for Fingertip Control
- Compact Size Small Jobs or Tight Work Areas
- 1-pc. Flat: 3/16"
- 1-pc. Flat: 1/4"
- 1-pc. Phillips: #1
- 1-pc. Phillips: #2

| Item | Description | Packaging | Cs | In |
|-------|----------------------------|--------------------|-----|----|
| 28071 | 4-pc. Mini Screwdriver Set | SLIDE BLISTER CARD | 288 | 12 |



6-pc. Long Precision Screwdriver Set

- Hardened and Tempered Carbon Steel Shafts
- Durable Chrome Plated Finish
- Knurled Nylon Handles for Fingertip Control
- Free-Turning End Caps Allow Constant Finger Pressure while Driving
- 1-pc. Flat: 2mm x 3"
- 1-pc. Flat: 3mm x 4"
- 1-pc. Flat: 4mm x 6"
- 1-pc. Phillips: #00 x 3"
- 1-pc. Phillips: #0 x 4"
- 1-pc. Phillips: #1 x 6"

| Item | Description | Packaging | Cs | In |
|------|--------------------------------------|--------------------|-----|----|
| 2974 | 6-pc. Long Precision Screwdriver Set | SLIDE BLISTER CARD | 120 | 12 |



6-pc. Precision Screwdriver Set

- Hardened Chrome Vanadium Steel
- Non-Slip Soft Grip Handles for Precise Control
- Free-Turning End Cap Allows Constant Finger Pressure While Turning
- Magnetized Tips
- Flat: 1.5mm x 50mm, 2mm x 50mm, 3mm x 50mm
- Phillips: #00 x 50mm, #0 x 50mm, #1 x 50mm
- Snap-in Organizer Case

| Item | Description | Packaging | Cs | In |
|------|---------------------------------|-----------------------|----|----|
| 2976 | 6-pc. Precision Screwdriver Set | SEALED BLISTER - FULL | 50 | 10 |



6-pc. Precision Screwdriver Set

- Hardened Carbon Steel Shafts with Black Oxide Finish
- Chrome Plated Alloy Steel Handles with Non-Slip Knurled Grips
- Free-Turning End Cap Allows Constant Finger Pressure while Driving
- 4-pc. Flat: 1.4mm, 2.0mm, 2.4mm, 3.0mm
- 2-pc. Phillips: #0-1, #1-2
- Complete with Organizer Case

| Item | Description | Packaging | Cs | In |
|------|---------------------------------|--------------------|----|----|
| 2985 | 6-pc. Precision Screwdriver Set | SLIDE BLISTER CARD | 96 | 12 |



16-pc. Precision Screwdriver Set

- Hardened Carbon Steel Shafts with Black Oxide Finish
- Chrome Plated Alloy Steel Handles with Non-Slip Knurled Grips
- Free-Turning End Cap Allows Constant Finger Pressure while Driving
- Hex and Nut Drivers with Hole in Handle for Lever Bar-Assisted Torque
- 6-pc. Flat: 1, 1.4, 2, 2.4, 3, 3.8mm
- 4-pc. Phillips: #0-2, #0, #1-2, #1-1
- 3-pc. Hex: 1.5, 2, 2.5mm
- 3-pc. Nut Drivers: 3, 4, 5mm
- Complete with Organizer Case

| Item | Description | Packaging | Cs | In |
|------|----------------------------------|--------------------|----|----|
| 2987 | 16-pc. Precision Screwdriver Set | SLIDE BLISTER CARD | 40 | 10 |



5-pc. Precision Nut Driver Set

- Hardened Carbon Steel Shafts with Black Oxide Finish
- Chrome Plated Alloy Steel Handles with Non-Slip Knurled Grips
- Free-Turning End Cap Allows Constant Finger Pressure while Driving
- Hole in Handle for Leverage Bar-Assisted Torque
- 5-pc. Nut Drivers: 3, 3.5, 4, 4.5, 5mm
- Complete with Organizer Case

| Item | Description | Packaging | Cs | In |
|------|--------------------------------|--------------------|----|----|
| 2988 | 5-pc. Precision Nut Driver Set | SLIDE BLISTER CARD | 72 | 12 |



7-pc. Precision Screwdriver with Magnifying Glass

- Hardened Carbon Steel Shafts with Black Oxide Finish
- Chrome Plated Alloy Steel Handles with Non-Slip Knurled Grips
- Free-Turning End Cap Allows Constant Finger Pressure while Driving
- Includes 2X Magnifying Glass for Better View of Small Projects
- 4-pc. Flat: 1.4mm, 2.0mm, 2.4mm, 3.0mm
- 2-pc. Phillips: #0-1, #1-2
- 1-pc. 2X Magnifying Glass
- Complete with Organizer Case

| Item | Description | Packaging | Cs | In |
|-------|---|--------------------|----|----|
| 82691 | 7-pc. Precision Screwdriver with Magnifying Glass | SLIDE BLISTER CARD | 96 | 6 |

40 Screwdrivers



6-pc. Screwdriver Set

- Hardened Carbon Steel Shafts
- Corrosion-Resistant Chrome Plated Finish
- Precision-Machined Magnetized Tips
- Sure Grip 4-Flute Handles
- 3-pc. Flat: 3/16" x 3", 1/4" x 4", 3/16" x 6"
- 3-pc. Phillips: #1 x 3", #2 x 4", #1 x 6"

| Item | Description | Packaging | Cs | In |
|------|-----------------------|--------------------|----|----|
| 2721 | 6-pc. Screwdriver Set | SLIDE BLISTER CARD | 48 | 6 |



5-pc. Screwdriver Set

- Hardened Carbon Steel Shafts
- Corrosion-Resistant Chrome Plated Finish
- Precision-Machined Magnetized Tips
- Sure Grip 4-Flute Handles
- 3-pc. Flat: 3/16" x 3", 1/4" x 4", 3/16" x 6"
- 2-pc. Phillips: #1 x 3", #2 x 4"

| Item | Description | Packaging | Cs | In |
|------|-----------------------|--------------------|----|----|
| 2725 | 5-pc. Screwdriver Set | SLIDE BLISTER CARD | 48 | 6 |



2-pc. Screwdriver Set

- Hardened Carbon Steel Shafts
- Corrosion-Resistant Chrome Plated Finish
- Precision-Machined Magnetized Tips
- Non-Slip Soft Handle Grips

- 2723
- 1-pc. Flat: 1/4" x 4"
 - 1-pc. Phillips: #2 x 4"

- 2724
- 2-pc. Flat: 3/16" x 4", 1/4" x 4"
 - 2-pc. Phillips: #1 x 4", #2 x 4"

| Item | Description | Packaging | Cs | In |
|------|-----------------------|--------------------|-----|----|
| 2723 | 2-pc. Screwdriver Set | SLIDE BLISTER CARD | 100 | 10 |
| 2724 | 4-pc. Screwdriver Set | SLIDE BLISTER CARD | 72 | 6 |



2-pc. Pocket Clip Screwdriver Set

- Heat Treated Carbon Steel Shafts
- Corrosion-Resistant Chrome Plated Finish
- Sure-Grip 6-Flute Handles
- Handy Pocket Pen Clip

- 1-pc. Flat: 1/8" x 2"
- 1-pc. Phillips: #0 x 2"

| Item | Description | Packaging | Cs | In |
|------|-----------------------------------|--------------------|----|----|
| 2971 | 2-pc. Pocket Clip Screwdriver Set | SLIDE BLISTER CARD | 72 | 12 |



Extra Long Screwdrivers

- Heat Treated Chrome Vanadium Steel Shaft
- Durable Chrome Plated Finish Resists Corrosion
- Precision-Machined Vapor Blasted Tip
- Cushioned Non-Slip Handle Grip

| Item | Description | Packaging | Cs | In |
|------|--|------------------|----|----|
| 2772 | 20" x 1/4" Flat Extra Long Screwdriver | BULK/COLOR LABEL | 48 | 6 |
| 2773 | 20" x #2 Phillips Extra Long Screwdriver | BULK/COLOR LABEL | 48 | 6 |



3-pc. Offset Screwdriver Set

- Heat-Treated Carbon Steel Construction
- Corrosion-Resistant Chrome Plated Finish
- Non-Slip Knurled Handles
- Reaches Fasteners Around Obstructions and in Tight Work Areas

- 1-pc. #1 Phillips x 3/16" Flat
- 1-pc. #2 Phillips x 1/4" Flat
- 1-pc. #3 Phillips x 5/16" Flat

| Item | Description | Packaging | Cs | In |
|------|------------------------------|--------------------|-----|----|
| 2944 | 3-pc. Offset Screwdriver Set | SLIDE BLISTER CARD | 100 | 10 |



2-pc. Offset Screwdriver Set

- Heat-Treated Carbon Steel Construction
- Corrosion-Resistant Chrome Plated Finish
- Non-Slip Knurled Handles
- Reaches Fasteners Around Obstructions and in Tight Work Areas

- 1-pc. #1 Phillips x 3/16" Flat
- 1-pc. #2 Phillips x 1/4" Flat

| Item | Description | Packaging | Cs | In |
|------|------------------------------|--------------------|-----|----|
| 2946 | 2-pc. Offset Screwdriver Set | SLIDE BLISTER CARD | 144 | 12 |

42 Screwdrivers



Screwdriver Sets

- Sandblasted, Chrome Vanadium Steel Bits
- Precision-Machined Bits for Exact Fit
- Chrome Plated Steel Shaft with Magnetic Bit Holder
- Comfortable Non-Slip Soft Handle Grip
- On-board Bit Storage in Handle Compartment

- 2790**
- 2-pc. Flat Bits (1"): 3/16", 1/4"
 - 2-pc. Phillips Bits (1"): #1, #2
 - 2-pc. Star Drive Bits (1"): SD-15, SD-20
 - 1-pc. Bit Screwdriver

- 2791**
- 2-pc. Flat Double-End Bits (2"): 1/8" x 5/32", 3/16" x 1/4"
 - 2-pc. Phillips Double-End Bits (2"): #0 x #1, #2 x #3
 - 1-pc. Star Drive Double-End Bit (2"): SD-15 x SD-20
 - 1-pc. Bit Screwdriver

| Item | Description | Packaging | Cs | In |
|------|-------------------------|-----------------------|-----|----|
| 2790 | 6-in-1 Screwdriver Set | SEALED BLISTER - HALF | 100 | 5 |
| 2791 | 10-in-1 Screwdriver Set | SEALED BLISTER - HALF | 100 | 5 |



6-in-1 Ratchet Screwdriver Set

- Sandblasted, Chrome Vanadium Steel Bits
- Precision-Machined Bits for Exact Fit
- Three-Function Ratchet Drive: Forward, Fixed, and Reverse
- Chrome Plated Steel Shaft with Magnetic Bit Holder
- Comfortable Non-Slip Soft Handle Grip
- On-board Bit Storage in Handle Compartment

- 2-pc. Flat Bits (1"): 3/16", 1/4"
- 2-pc. Phillips Bits (1"): #1, #2
- 2-pc. Star Drive Bits (1"): SD-15, 20
- 1-pc. Ratchet Bit Screwdriver

| Item | Description | Packaging | Cs | In |
|------|--------------------------------|-----------------------|-----|----|
| 2792 | 6-in-1 Ratchet Screwdriver Set | SEALED BLISTER - HALF | 100 | 10 |



6-in-1 Screwdriver Set

- Sandblasted, Chrome Vanadium Steel Bits
- Precision-Machined Bits for Exact Fit
- Chrome Plated Steel Shaft with Magnetic Bit Holder
- Comfortable Non-Slip Soft Handle Grip
- On-board Bit Storage in Handle Compartment

- 2-pc. Flat Bits (1"): 3/16", 1/4"
- 2-pc. Phillips Bits (1"): #1, #2
- 2-pc. Star Drive Bits (1"): SD-15, 20
- 1-pc. Bit Screwdriver

| Item | Description | Packaging | Cs | In |
|------|------------------------|-----------------------|-----|----|
| 2793 | 6-in-1 Screwdriver Set | SEALED BLISTER - HALF | 120 | 12 |



22-pc. Flex Head Ratchet Screwdriver Set

- Flex Head Screwdriver Locks at Five Drive Angles
- Three-Function Ratchet Drive: Forward, Fixed and Reverse
- Chrome Plated Magnetic Bit Holder
- Cushioned Non-Slip Handle Grip Reduces Fatigue
- Sandblasted Chrome Vanadium Steel Bits
- Precision-Milled Bit Tips for Exact Fit

- 1-pc. Flex Head Ratchet Screwdriver
- 3-pc. Flat Bits (1"): 5/32", 3/16", 1/4"
- 3-pc. Phillips Bits (1"): #0, #1, #2
- 6-pc. Star Drive Bits (1"): SD-10, 15, 20, 25, 27, 30
- 3-pc. Square Bits (1"): S-1, S-2, S-3
- 3-pc. Clutch Bits (1"): 5/32", 3/16", 1/4"
- 3-pc. Bit Organizers

| Item | Description | Packaging | Cs | In |
|------|--|--------------------|----|----|
| 2825 | 22-pc. Flex Head Ratchet Screwdriver Set | SLIDE BLISTER CARD | 48 | 6 |



- AVAILABLE IN DISPLAY QUANTITIES ONLY

6-in-1 Screwdriver

- Precision-Machined Sandblasted Chrome Vanadium Steel Bits
- Comfortable Oversized Mechanic's-Style Handle for Sure Grip
- Rugged Steel Bit Holder Shaft with Corrosion-Resistant Chrome Plated Finish
- Spring-Loaded Ball Bearings Lock Bits and Shaft in Place

- Six Drivers in One!
- Flat: 3/16" and 1/4"
- Phillips: #1 and #2
- Nut Drivers: 1/4" and 5/16"

| Item | Description | Packaging | Cs | In |
|------|--------------------|--------------------|----|----|
| 2799 | 6-in-1 Screwdriver | 12-PC. DISPLAY BOX | 10 | 1 |



- MINIMUM ORDER QUANTITY: 10-PC. POLYBAG

6-in-1 Screwdriver Replacement Bits

- Hardened Chrome Vanadium Steel Construction
- Corrosion-Resistant Sandblasted Finish
- Replacement Bit for TEKTON® #2799 6-in-1 Screwdriver and Most Standard 6-in-1 Screwdrivers

| Item | Description | Packaging | Cs | In |
|------|---|-----------------|------|-----|
| 2925 | 6-in-1 Screwdriver Replacement Bit (1/4" Flat x #2 Phillips) | 10 PCS. POLYBAG | 1000 | 100 |
| 2926 | 6-in-1 Screwdriver Replacement Bit (3/16" Flat x #1 Phillips) | 10 PCS. POLYBAG | 1000 | 100 |



- AVAILABLE IN DISPLAY QUANTITIES ONLY

2-in-1 Pocket Pro Screwdriver

- 4-1/2" Double-End Chrome Vanadium Steel Bit: 3/16" Flat x #1 Phillips
- Precision-Machined Magnetized Tips
- Compact Size with Pocket Clip

| Item | Description | Packaging | Cs | In |
|-------|-------------------------------|-----------------|----|----|
| 28031 | 2-in-1 Pocket Pro Screwdriver | 72-PC. FISHBOWL | 4 | 1 |



- AVAILABLE IN DISPLAY QUANTITIES ONLY

4-in-1 Pocket Screwdriver

- Durable Heat Treated Bits with Satin Finish
- Handy Pen Style Case with Pocket Clip
- Perfect For Electronics, Hobbies, and Eyeglasses Repairs
- Four Drivers in One: 1/8" Flat x #0 Phillips, 1/16" Flat x #00 Phillips

| Item | Description | Packaging | Cs | In |
|-------|---------------------------|--------------------|----|----|
| 28111 | 4-in-1 Pocket Screwdriver | 72-PC. DISPLAY BOX | 6 | 1 |



22-pc. T-Handle Socket Screwdriver Set

- Sandblasted, Chrome Vanadium Steel Bits
- Heat Treated, Chrome Plated 6-Point Sockets
- High-Torque T-Handle Driver
- Chrome Plated Carbon Steel Shaft
- Bit Storage in Handle
- 9-pc. 1/4" Drive 6-Point Sockets (SAE): 3/16", 7/32", 1/4", 5/16", 11/32", 3/8", 7/16", 15/32", 1/2"
- 5-pc. Flat Bits (1"): 1/8", 5/32", 3/16", 1/4", 9/32"
- 3-pc. Phillips Bits (1"): #1, #2, #3
- 3-pc. Star Drive Bits (1"): SD-15, SD-20, SD-30
- 1-pc. 1/4" Hex x 1/4" Dr. Socket Adapter
- 1-pc. T-Handle Driver
- Complete with Bit and Socket Organizers

| Item | Description | Packaging | Cs | In |
|------|--|-----------------------|----|----|
| 2822 | 22-pc. T-Handle Socket Screwdriver Set | SEALED BLISTER - FULL | 48 | 6 |



11-pc. Mini Ratchet and Bit Set

- Sandblasted, Hardened Chrome Vanadium Steel Bits with Precision-Milled Tips for Exact Fit
- Compact Ratchet with Forward/Reverse Drive and Built-in Speed Disc
- 2-pc. Flat Bits (1"): 3/16", 1/4"
- 3-pc. Phillips Bits (1"): #0, #1, #2
- 5-pc. Star Drive Bits (1"): SD-10, 15, 20, 25, 30
- 1-pc. 4" Ratchet Driver
- Complete with Bit Organizer

| Item | Description | Packaging | Cs | In |
|------|---------------------------------|--------------------|-----|----|
| 2888 | 11-pc. Mini Ratchet and Bit Set | SLIDE BLISTER CARD | 144 | 12 |



58-pc. Ratchet Driver and Bit Set

- Sandblasted Chrome Vanadium Steel Bits
- Ratchet Driver with Soft Non-Slip Handle Grip
- Forward, Fixed, and Reverse Drive Functions
- Chrome Plated Flex Extension
- 42-pc. 1" Screwdriver Bits:
 - Flat: 3mm, 4mm (2-pc.), 5mm (3-pc.), 6mm (2-pc.), 7mm
 - Star: SD-10, SD-15 (2-pc.), SD-20 (2-pc.), SD-25, SD-27, SD-30, SD-40
 - Hex: 2mm, 2.5mm, 3mm, 4mm, 5mm, 5.5mm, 6mm
 - Phillips: #0, #1 (3-pc.), #2 (4-pc.), #3 (2-pc.)
 - Pozi: PZ0, PZ1 (2-pc.), PZ2 (2-pc.), PZ3 (2-pc.)
- 7-pc. Nut Driver (SAE): 3/16", 1/4", 9/32", 11/32", 5/16", 3/8", 7/16"
- 7-pc. Nut Drivers (MM): 5, 6, 7, 8, 9, 10, 11mm
- 1-pc. 8" Flexible Extension
- 1-pc. Ratchet Driver Handle
- Complete with 8 Bit Organizers

| Item | Description | Packaging | Cs | In |
|------|-----------------------------------|-----------------------|----|----|
| 2837 | 58-pc. Ratchet Driver and Bit Set | SEALED BLISTER - FULL | 24 | 6 |

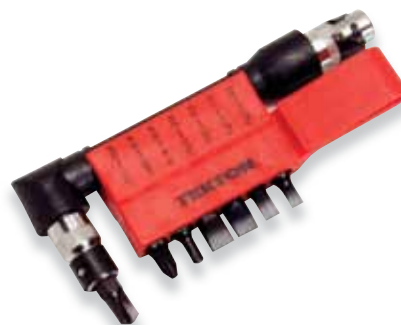

14-in-1 Offset Screwdriver Set

- Double-End Chrome Vanadium Steel Bits
- Precision-Milled Tips for Exact Fit
- Double-End Straight/90-Degree Offset Driver
- Reaches Screws in Angles and Tight Places that Conventional Drivers Cannot
- 7-pc. Driver Bits: #0 Phillips x 5/32" Flat, #1 Phillips x 3/16" Flat, #2 Phillips x 1/4" Flat, #3 Phillips x 9/32" Flat, SD-15 x SD-20, SD-10 x Drywall #2, S-2 x Clutch 1/4"
- 1-pc. Offset Driver
- Complete with Belt Storage Clip

| Item | Description | Packaging | Cs | In |
|------|--------------------------------|--------------------|----|----|
| 2945 | 14-in-1 Offset Screwdriver Set | SLIDE BLISTER CARD | 72 | 12 |

105-pc. Everybit™ Ratchet Screwdriver and Bit Set

- Every Bit for Any Project
- Twelve Bit Types, Each in a Full Range of Sizes

Screwdriver Bits:

- Chrome Vanadium, Chrome Molybdenum and S2 Steel Construction
- Corrosion-Resistant Sandblasted Finish
- Use Bits with any Power Driver

Ratchet Screwdriver:

- 3-Function Ratchet Screwdriver: Forward, Fixed, and Reverse Drive
- Comfortable, Oversized Quadra-Torque™ Handle Generates Extra Torque

- 10-pc. Flat Bits (1"): 3/32", 7/64", 1/8", 9/64", 5/32", 3/16", 7/32", 1/4", 9/32", 5/16"
- 6-pc. Phillips Bits (1"): #0, #1, #2, #3, #4; Dry: #2
- 5-pc. Square Bits (1"): S-0, S-1, S-2, S-3, S-4
- 16-pc. Star Drive Bits (1"): SD-5, 5.5, 6, 7, 8, 9, 10, 15, 20, 25, 27, 30, 35, 40, 45, 50
- 5-pc. Pozi Bits (1"): PZ-0, PZ-1, PZ-2, PZ-3, PZ-4
- 12-pc. Hex Bits (1"): (SAE) 1/16", 5/64", 3/32", 7/64", 1/8", 9/64", 5/32", 3/16", 7/32", 1/4", 9/32", 5/16"
- 10-pc. Hex Bits (1"): (Metric) 1.5, 2, 2.5, 3, 4, 5, 5.5, 6, 7, 8
- 5-pc. Clutch Bits (1"): 1/8", 5/32", 3/16", 1/4", 7/32"
- 9-pc. Tamper Star Drive Bits (1"): SD-8, 10, 15, 20, 25, 27, 30, 35, 40
- 6-pc. Tamper Hex Bits (1"): (SAE) 5/32", 9/64", 1/8", 7/64", 3/32", 5/64"
- 6-pc. Tamper Hex Bits (1"): (Metric) 2, 2.5, 3, 4, 5, 6
- 4-pc. Tri-Wing Bits (1"): 1, 2, 3, 4
- 4-pc. Spanner Bits (1"): 4, 6, 8, 10mm
- 3-pc. Torq Bits (1"): 6, 8, 10mm
- 1-pc. 2-5/16" Magnetic Extension Bit Holder
- 1-pc. 1/4" Hex X 1/4" Dr. Socket Adapter
- 1-pc. Quadra-Torque™ Ratchet Handle
- 1-pc. Organizer Carry Case



| Item | Description | Packaging | Cs | In |
|------|---|-----------------------|----|----|
| 2840 | 105-pc. Everybit™ Ratchet Screwdriver and Bit Set | SEALED BLISTER - FULL | 12 | 6 |



30-pc. Compact Screwdriver and Bit Set

- Heat Treated, Sandblasted, Chrome Vanadium Steel Bits
- Precision-Machined Tips
- Chrome Plated Shaft
- Strong Magnetic Bit Holder
- Contoured Fluted Handle for Sure Grip
- Convenient, Compact Snap-in Organizer Case for Easy Storage

- 5-pc. Flat Bits (1"): 1/8", 5/32", 3/16", 1/4", 9/32"
- 4-pc. Phillips Bits (1"): #0, #1, #2, #3
- 6-pc. Star Drive Bits (1"): SD-10, 15, 20, 25, 30, 40
- 4-pc. Square Bits (1"): S-0, S-1, S-2, S-3
- 5-pc. Hex Bits (1"): 5/64", 3/32", 7/64", 1/8", 9/64"
- 2-pc. Pozi Bits (1"): PZ-1, PZ-2
- 1-pc. 1/4" Hex x 1/4" Dr. Socket Adapter
- 1-pc. 1/4" Dr. x 1/4" Hex Socket/Bit Adapter
- 1-pc. Pro Driver Handle
- 1-pc. Snap-In Organizer Case

| Item | Description | Packaging | Cs | In |
|------|--|--------------------|----|----|
| 2842 | 30-pc. Compact Screwdriver and Bit Set | PLASTIC CASE/LABEL | 48 | 6 |

55-pc. Ratchet Screwdriver, Bit and Socket Set

- Sandblasted Chrome Vanadium Steel Bits
- Drop Forged Chrome Plated 6-Point Sockets
- 3-Function Ratchet Screwdriver: Forward, Fixed and Reverse Drive Positions
- Comfortable Oversized Screwdriver Handle
- Bits and Accessories Fit All Power and Cordless Drills and Drivers

- 1-pc. Ratchet Screwdriver
- 4-pc. Flat Bits (2"): 5/32", 3/16", 1/4", 9/32"
- 5-pc. Phillips Bits (2"): #0, #1, #2, #3 Dry: #2
- 3-pc. Square Bits (2"): S-1, S-2, S-3
- 5-pc. Hex Bits (1"): (SAE) 1/8", 5/32", 3/16", 7/32", 1/4"
- 5-pc. Hex Bits (1"): (Metric) 2, 3, 4, 5, 6
- 6-pc. Star Drive Bits (1"): SD-10, 15, 20, 25, 27, 30
- 1-pc. Bit Organizer
- 9-pc. 1/4" Dr. Sockets (SAE): 3/16", 7/32", 1/4", 5/16", 11/32", 3/8", 7/16", 15/32", 1/2"
- 9-pc. 1/4" Dr. Sockets (Metric): 5, 6, 7, 8, 9, 10, 11, 12, 13
- 2-pc. Socket Organizers
- 1-pc. 2-5/16" Magnetic Bit Holder
- 1-pc. 1/4" Hex x 1/4" Dr. Socket Adapter (2")
- 2-pc. Precision Screwdrivers: 2mm Flat, #00 Phillips
- 1-pc. Storage Case

| Item | Description | Packaging | Cs | In |
|------|--|-----------------------|----|----|
| 2846 | 55-pc. Ratchet Screwdriver, Bit and Socket Set | SEALED BLISTER - FULL | 12 | 1 |

46 Screwdrivers



7-pc. Impact Driver Sets

- Professional-Grade Impact Screwdriver with Non-Slip, Knurled Grip Handle
- Forward and Reverse Drive
- Corrosion-Resistant Chrome Plated Finish
- Hardened Chrome Vanadium Steel Bits
- Precision-Milled Tips for Exact Fit
- Loosens Rusted or Over-Tightened Screws

2905

- 1-pc. Impact Driver
- 4-pc. Screwdriver Bits: Flat: 5/16", 3/8" Phillips: #2, #3
- 1-pc. 3/8" Drive Bit Chuck
- 1-pc. Metal Storage Case

2910

- 1-pc. Impact Driver
- 4-pc. Screwdriver Bits: Flat: 5/16", 3/8" Phillips: #2, #3
- 1-pc. 1/2" Drive Bit Chuck
- 1-pc. Metal Storage Case

| Item | Description | Packaging | Cs | In |
|------|------------------------------------|-----------|----|----|
| 2905 | 7-pc. 3/8" Drive Impact Driver Set | COLOR BOX | 20 | 1 |
| 2910 | 7-pc. 1/2" Drive Impact Driver Set | COLOR BOX | 20 | 1 |



Magnetic Bit Holders

- Chrome Plated Alloy Steel Tube
- Universal Fit 1/4" Chrome Vanadium Steel Hex Shank
- Strong Magnet Retains Bit in Place
- Accepts any 1/4" Hex Shank Driver Bit

2887

- MINIMUM ORDER QUANTITY: 10-PC. POLYBAG

| Item | Description | Packaging | Cs | In |
|------|----------------------------|--------------------|------|-----|
| 2869 | 2-1/2" Magnetic Bit Holder | SLIDE BLISTER CARD | 288 | 12 |
| 2887 | 2-1/2" Magnetic Bit Holder | 10-PC. POLYBAG/UPC | 1000 | 100 |
| 2901 | 6" Magnetic Bit Holder | SLIDE BLISTER CARD | 288 | 12 |



8-pc. Impact Screwdriver Bit Set

- Hardened Chrome Vanadium Steel Bits
- Corrosion-Resistant Sandblasted Finish
- Precision-Milled Tips for Exact Fit
- Universal Fit 3/8" Hex Shanks

- 4-pc. Screwdriver Bits (1-7/16"): Flat: 5/16", 3/8"; Phillips Bits: #2, #3
- 4-pc. Screwdriver Bits (3-3/16"): Flat: 5/16", 3/8"; Phillips Bits: #2, #3

| Item | Description | Packaging | Cs | In |
|------|----------------------------------|--------------|----|----|
| 2915 | 8-pc. Impact Screwdriver Bit Set | BLISTER CARD | 72 | 12 |

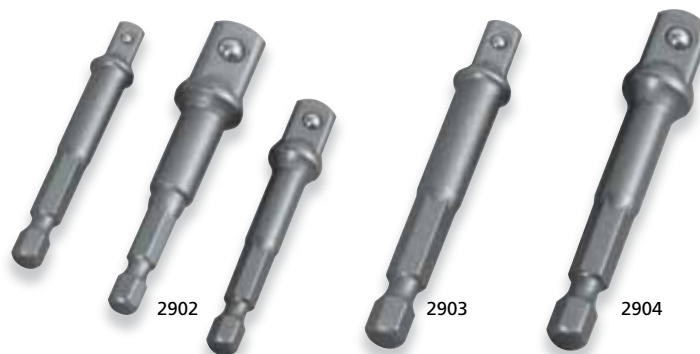

Power Extension Bars

- Sandblasted Chrome Vanadium Steel
- Spring-Loaded Ball Bearing Locks on to Sockets
- Adapts any Power Drill to Drive Sockets

2902

- 1-pc. 1/4" Hex x 1/4" Dr.
- 1-pc. 1/4" Hex x 3/8" Dr.
- 1-pc. 1/4" Hex x 1/2" Dr.

2903 / 2904

- MINIMUM ORDER QUANTITY: 10-PC. POLYBAG

| Item | Description | Packaging | Cs | In |
|------|---|--------------------|------|-----|
| 2902 | 3-pc. Power Socket Adapter Set | SLIDE BLISTER CARD | 72 | 12 |
| 2903 | 1/4" Hex x 1/4" Drive Power Extension Bar | 10-PC. POLYBAG/UPC | 1000 | 100 |
| 2904 | 1/4" Hex x 3/8" Drive Power Extension Bar | 10-PC. POLYBAG/UPC | 1000 | 100 |

25-pc. 1" Power Bit Set Ph #2

- Hardened Nickel Chrome Molybdenum Steel
- Sandblasted Finish Resists Corrosion
- Precision-Milled Tip for Exact Fit
- Universal Fit 1/4" Hex Shank

- 25-pc. Phillips Bits (1"): #2

| Item | Description | Packaging | Cs | In |
|-------|-------------------------------|--------------|----|----|
| 82545 | 25-pc. 1" Power Bit Set Ph #2 | BLISTER CARD | 72 | 6 |



Retracting Screw Holder/Driver

- Retractable Sleeve Guides Screw for a Straight Drive Every Time
- Magnetized Tip Holds Screw in Position for Accurate Start
- Allows One Hand Driving - Frees Second Hand for Positioning Work Pieces
- Prevents Screw Wandering in Tough Wood Grain and Near other Holes
- Screw Capacity: 2-1/2" Length
- Sandblasted Chrome Vanadium Steel Bits
- 1-pc. Retracting Screw Holder/Driver
- 2-pc. Flat Bits (1"): 3/16", 1/4"
- 2-pc. Phillips Bits (1"): #1, #2
- 1-pc. Drywall Bit (1"): #2
- 1-pc. Bit Holder



| Item | Description | Packaging | Cs | In |
|------|--------------------------------|--------------------|-----|----|
| 2899 | Retracting Screw Holder/Driver | SLIDE BLISTER CARD | 144 | 12 |

8" Flex Extension Bit Holder

- Flexible Heat-Treated Spring Steel Shaft
- Durable Corrosion-Resistant Enamel Finish
- Retainer Collar Locks Bit in Place
- Universal Fit for all 1/4" Hex Shank Screwdriver Bits
- Designed for Use with Power Drills and Drivers
- Replacement Retainer Collar Kit Included



| Item | Description | Packaging | Cs | In |
|------|------------------------------|--------------------|-----|----|
| 2900 | 8" Flex Extension Bit Holder | SLIDE BLISTER CARD | 144 | 12 |

11-pc. Bit and Driver Set

- Sandblasted S2 Steel Screwdriver Bits
- Knurled Locking Collar with Anodized Finish
- Stainless Steel Magnetic Bit Holder
- 1-pc. 2-3/8" Quick Release Bit Holder
- 9-pc. 1" Screwdriver Bits: Flat: 3/16", 1/4"; Phillips: #1, #2; Star Drive: SD-10, 15, 20, 25, 30
- 1-pc. 1" Socket Adapter

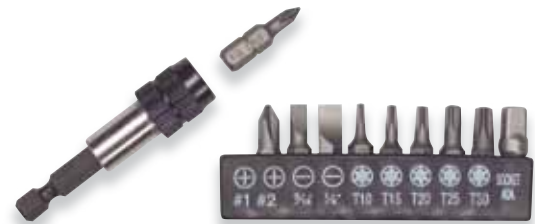

| Item | Description | Packaging | Cs | In |
|------|---------------------------|-----------------------|-----|----|
| 2909 | 11-pc. Bit and Driver Set | SEALED BLISTER - FULL | 144 | 24 |

33-pc. Security Bit Set

- Sandblasted Chrome Vanadium Steel Construction
- Precision-Milled Tips for Exact Fit
- Universal Fit 1/4" Hex Shank
- Security Bits Fit Five Common Styles of Tamper-Resistant Fasteners
- 3-pc. Torque Bits (1"): 6, 8, 10mm
- 4-pc. Spanner Bits (1"): 4, 6, 8, 10mm
- 4-pc. Tri-Wing Bits (1"): #1, #2, #3, #4
- 6-pc. Hex Bits (1"): (SAE) 5/32, 9/64, 1/8, 7/64, 3/32, 5/64
- 6-pc. Hex Bits (1"): (Metric) 2, 2.5, 3, 4, 5, 6mm
- 9-pc. Star Drive Bits (1"): SD-8, 10, 15, 20, 25, 27, 30, 35, 40
- 1-pc. 2-1/2" Magnetic Extension Bit Holder
- Complete with Bit Organizer



| Item | Description | Packaging | Cs | In |
|------|-------------------------|--------------------|----|----|
| 2930 | 33-pc. Security Bit Set | SLIDE BLISTER CARD | 72 | 12 |

33-pc. Screwdriver Bit Set

- Sandblasted Chrome Vanadium Steel Construction
- Precision-Milled Tips for Exact Fit
- Universal Fit 1/4" Hex Shank
- Features the Most Common Sizes in One Compact Set
- 32-pc. 1" Screwdriver Bits Sizes: Flat: 1/8, 5/32, 3/16, 1/4, 9/32" Phillips: #0, 1, 2 (3-Pcs.), #3 Drywall: #2 (2-Pc.) Star: SD-10, SD-15, SD-20, SD-25, SD-27, SD-30, SD-40 Square: S-0, S-1, S-2, S-3 Hex: 3/32, 5/64, 7/64, 1/8, 9/64, 5/32, 3/16, 1/4"
- 1-pc. 2-5/16" Magnetic Bit Holder
- Complete with Bit Organizer



| Item | Description | Packaging | Cs | In |
|-------|----------------------------|--------------------|----|----|
| 82157 | 33-pc. Screwdriver Bit Set | SLIDE BLISTER CARD | 72 | 6 |

48 Screwdrivers



6-pc. 1" Mini Star Bit Set

- Sandblasted S-2 Steel
- Precision Milled Tips for Exact Fit
- Universal Fit 1/4" Hex Shank
- 6-pc. Star Drive Bits (1"): 5, 5.5, 6, 7, 8, 9
- Complete with Bit Organizer

| Item | Description | Packaging | Cs | In |
|------|----------------------------|--------------------|-----|----|
| 2883 | 6-pc. 1" Mini Star Bit Set | SLIDE BLISTER CARD | 250 | 10 |



7-pc. 1" Security Star Bit Set

- Sandblasted S-2 Steel
- Precision-Milled Tips for Exact Fit
- Universal Fit 1/4" Hex Shank
- Security Bits Fit Tamper-Resistant Star Drive Fasteners
- 7-pc. Tamper Star Bits (1"): SD-10, 15, 20, 25, 27, 30, 40
- Complete with Bit Organizer

| Item | Description | Packaging | Cs | In |
|------|--------------------------------|--------------------|-----|----|
| 2886 | 7-pc. 1" Security Star Bit Set | SLIDE BLISTER CARD | 250 | 50 |



6-pc. 1" Star Drive Bit Set

- Sandblasted Chrome Vanadium Steel
- Precision-Milled Tips for Exact Fit
- Universal Fit 1/4" Hex Shank
- 6-pc. Star Drive Bits (1"): SD-10, 15, 20, 25, 27, 30
- Complete with Bit Organizer

| Item | Description | Packaging | Cs | In |
|------|-----------------------------|--------------------|-----|----|
| 2870 | 6-pc. 1" Star Drive Bit Set | SLIDE BLISTER CARD | 250 | 50 |



15-pc. 1/2" Drive Star Bit Set

- Drop Forged, Heat Treated Chrome Vanadium Steel
- Corrosion-Resistant Sandblasted Finish
- Precision-Machined Tips for Exact Fit
- 7-pc. 3/8" Hex Star Bits (1-1/4") : SD-20, SD-25, SD-30, SD-40, SD-45, SD-50, SD-55
- 7-pc. 3/8" Hex Star Bits (3") : SD-20, SD-25, SD-30, SD-40, SD-45, SD-50, SD-55
- 1-pc. 1/2" Drive Bit Adapter Socket
- Complete with Storage Case

| Item | Description | Packaging | Cs | In |
|------|--------------------------------|-----------------------|----|----|
| 4918 | 15-pc. 1/2" Drive Star Bit Set | SEALED BLISTER - FULL | 24 | 1 |

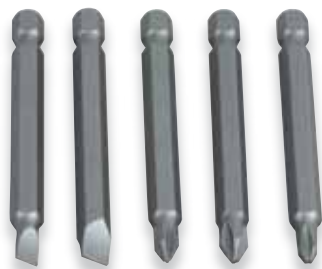

5-pc. 3" Power Bit Set

- Nickel Chrome Moly Steel Construction
- Durable Sandblasted Finish
- Precision-Milled for Exact Fit
- Universal 1/4" Hex Shank
- 2-pc. Flat Bits (3"): 3/16", 1/4"
- 2-pc. Phillips Bits (3"): #1, #2
- 1-pc. Drywall Bit (3"): #2

| Item | Description | Packaging | Cs | In |
|------|------------------------|--------------------|-----|----|
| 2919 | 5-pc. 3" Power Bit Set | SLIDE BLISTER CARD | 144 | 12 |



2912



2913

10-pc. Power Bit Sets

- Nickel Chrome Molybdenum Steel Construction
- Durable Sandblasted Finish
- Precision-Milled for Exact Fit
- Universal 1/4" Hex Shank
- 4-pc. Flat: 5/32", 3/16", 1/4", 9/32"
- 4-pc. Phillips: #0, #1, #2, #3
- 2-pc. Star Drive: SD-15, SD-20
- Complete with Workbelt Storage Clip

| Item | Description | Packaging | Cs | In |
|------|--|--------------------|----|----|
| 2912 | 10-pc. 2" Power Bit Set | SLIDE BLISTER CARD | 72 | 12 |
| 2913 | 10-pc. 2-1/2" Double-End Power Bit Set | SLIDE BLISTER CARD | 72 | 12 |



14-pc. Power Nut Driver Bit Set

- Forged and Hardened Chrome Vanadium Steel
- Corrosion-Resistant Sandblasted Finish
- Universal 1/4" Hex Shanks
- 7-pc. Power Nut Driver Bits (SAE): 3/16", 1/4", 9/32", 5/16", 11/32", 3/8", 7/16"
- 7-pc. Power Nut Driver Bits (Metric): 5, 5.5, 6, 7, 8, 10, 12mm
- Complete with Workbelt Storage Clip

| Item | Description | Packaging | Cs | In |
|------|---------------------------------|--------------------|----|----|
| 2928 | 14-pc. Power Nut Driver Bit Set | SLIDE BLISTER CARD | 72 | 12 |



7-pc. Power Nut Driver Bit Set

- Forged and Hardened Chrome Vanadium Steel
- Corrosion-Resistant Sandblasted Finish
- Universal 1/4" Hex Shanks
- 7-pc. Power Nut Driver Bits (SAE): 3/16", 1/4", 9/32", 5/16", 11/32", 3/8", 7/16"
- Complete with Workbelt Storage Clip

| Item | Description | Packaging | Cs | In |
|------|--------------------------------|--------------------|----|----|
| 2935 | 7-pc. Power Nut Driver Bit Set | SLIDE BLISTER CARD | 72 | 12 |

Magnetic Nut Drivers

- Sandblasted Chrome Vanadium Steel
- Magnet Retains Fastener in Place for Easy Starting
- Universal Fit 1/4" Hex Shank
- MINIMUM ORDER QUANTITY: 10-PC. POLYBAG

| Item | Description | Packaging | Cs | In |
|------|-------------------------------------|--------------------|-----|----|
| 2895 | 7/16" x 2-9/16" Magnetic Nut Driver | 10-PC. POLYBAG/UPC | 500 | 10 |
| 2896 | 1/4" x 2-9/16" Magnetic Nut Driver | 10-PC. POLYBAG/UPC | 500 | 10 |
| 2897 | 5/16" x 2-9/16" Magnetic Nut Driver | 10-PC. POLYBAG/UPC | 500 | 10 |
| 2898 | 3/8" x 2-9/16" Magnetic Nut Driver | 10-PC. POLYBAG/UPC | 500 | 10 |



3-pc. Magnetic Nut Driver Set

- Sandblasted Chrome Vanadium Steel
- Magnet Retains Fastener in Place for Easy Starting
- Universal Fit 1/4" Hex Shank
- 2-9/16" Overall Length

| Item | Description | Packaging | Cs | In |
|------|-------------------------------|--------------------|-----|----|
| 2906 | 3-pc. Magnetic Nut Driver Set | SLIDE BLISTER CARD | 144 | 12 |





20-pc. Quick-Change Power Drill Bit Set

- Carbide-Tipped Steel Masonry Drill Bits Power Through Concrete, Brick and Block
- Industrial High Speed Steel Drill Bits Penetrate Metal, Wood, Plastic and Fiberglass
- High-Carbon Steel Spade Bits Cut Quickly and Cleanly Through Wood
- Spring-Loaded Chuck Releases Bit with One Touch
- 1-pc. Quick Change Bit Chuck
- 10-pc. HSS Drill Bits (1/4" Hex Shank): 1/16, 5/64, 3/32, 7/64, 1/8, 9/64, 5/32, 3/16, 7/32, 1/4"
- 5-pc. Spade Drill Bits (1/4" Hex Shank): 3/8, 1/2, 5/8, 3/4, 7/8"
- 3-pc. Masonry Drill Bits (1/4" Hex Shank): 1/8, 3/16, 1/4"
- 1-pc. Snap-In Organizer Case

| Item | Description | Packaging | Cs | In |
|-------|---|-----------------------|----|----|
| 29431 | 20-pc. Quick-Change Power Drill Bit Set | SEALED BLISTER - FULL | 12 | 1 |

- 6-pc. Flat Bits (1"): 1/8" (2), 3/16" (2), 1/4" (2)
- 9-pc. Phillips Bits (1"): #0, #1 (2), #2 (5), #3
- 5-pc. Drywall Bits (1"): #2 (5)
- 4-pc. Square Bits (1"): #1, #2 (2), #3
- 6-pc. Hex Bits (1") (SAE): 3/32", 1/8", 5/32", 3/16", 7/32", 1/4"
- 4-pc. Hex Bits (1") (Metric): 3, 4, 5, 6mm
- 5-pc. Clutch Bits (1"): 1/8", 5/32", 3/16", 1/4", 7/32"
- 1-pc. 1/4" Hex x 1/4" Drive Socket Adapter
- 6-pc. Flat Bits (2"): 1/8", 5/32", 3/16", 1/4" (2), 9/32"
- 5-pc. Phillips Bits (2"): #0, #1, #2 (2), #3
- 2-pc. Drywall Bits (2"): #2 (2)
- 5-pc. Square Bits (2"): #0, #1, #2 (2), #3
- 7-pc. Star Drive Bits (2"): SD-10, 15, 20, 25, 27, 30, 40
- 2-pc. Double-Ended Bits (2-1/2"): #2 x 1/4", #1 x 3/16"
- 7-pc. Power Nut Drivers (SAE): 3/16", 1/4", 9/32", 5/16", 11/32", 3/8", 7/16"
- 7-pc. Power Nut Drivers (Metric): 5, 6, 7, 8, 9, 10, 11mm
- 1-pc. 2-5/16" Magnetic Bit Holder
- 2-pc. Screw Finders
- 2-pc. Round Bit Organizer Clips
- 4-Pc. Bit Organizer Clips
- 13-pc. High Carbon Steel Drill Bits: 1/16", 5/64", 3/32", 7/64", 1/8", 9/64", 5/32", 11/64", 3/16", 13/64", 7/32", 15/64", 1/4"
- 3-pc. Spade Bits (for Wood): 1/2", 5/8", 3/4"
- 8-pc. Brad Point Drill Bits (for Wood): 1/8", 5/32", 3/16", 1/4", 9/32", 5/16", 11/32", 3/8"
- 4-pc. Masonry Drill Bits (Carbide Tip): 1/8", 3/16", 1/4", 5/16"
- 4-pc. Hole Saws: 1-1/4", 1-1/2", 1-3/4", 2-1/8"
- 1-pc. Hole Saw Mandrel
- 1-pc. Nail Set
- 1-pc. Counter Sink
- Complete with Carry Case

| Item | Description | Packaging | Cs | In |
|-------|-----------------------------|-----------------------|----|----|
| 29437 | 125-pc. Drill and Drive Set | SEALED BLISTER - FULL | 6 | 1 |



42-pc. Quick-Change Power Driver Bit Set

- All-in-One Power Driver System Includes One-Touch, Quick-Change Bit Chuck
- Hardened, Chrome Vanadium Steel Bits with Corrosion-Resistant, Sandblasted Finish
- 1-pc. Quick-Change Bit Chuck
- 1-pc. Retracting Screw Holder/Driver
- 1-pc. 4" Extension Bit Holder
- 1-pc. 1/4" Hex x 3/8" Dr. Power Socket Adapter
- 7-pc. Power Nut Drivers (SAE): 3/16", 1/4", 9/32", 5/16", 11/32", 3/8", 7/16"
- 2-pc. Flat Bits (1"): 3/16", 1/4"
- 3-pc. Phillips Bits (1"): #1, #2 (2)
- 2-pc. Drywall Bits (1"): #2 (2)
- 5-pc. Star Drive Bits (1"): SD-10, 15, 20, 25, 30
- 7-pc. Flat Bits (2"): 1/8", 5/32", 3/16" (2), 1/4" (2), 9/32"
- 5-pc. Phillips Bits (2"): #0, #1, #2 (2), #3
- 2-pc. Drywall Bits (2"): #2 (2)
- 4-pc. Square Bits (2"): S-1, S-2 (2), S-3
- 1-pc. Tri-Fold Organizer Case

| Item | Description | Packaging | Cs | In |
|-------|--|-----------------------|----|----|
| 29432 | 42-pc. Quick-Change Power Driver Bit Set | SEALED BLISTER - FULL | 12 | 1 |

125-pc. Drill and Drive Set

- All-in-One Project Set for Power Drills with a Complete Assortment of Drill Bits, Screwdriver Bits and Accessories
- Precision-Milled, Chrome Vanadium Steel Screwdriver Bits with Rugged Sandblasted Finish
- Roll Forged, High Carbon Steel Multi-Purpose Drill Bits
- High Carbon Steel Spade Bits for Wood
- Carbide-Tipped Masonry Drill Bits



Individual Power Bits

- Sandblasted Chrome Vanadium Steel
- Precision Milled Bits
- 1/4" Hex Drive

• MINIMUM ORDER QUANTITY: 10-PC. POLYBAG

1" (25mm) BITS

| Item | Description | Packaging | Cs | In |
|------|----------------------------------|--------------------|------|-----|
| 2850 | #1 Square x 1" (25mm) Bit | 10-PC. POLYBAG/UPC | 1000 | 100 |
| 2851 | #2 Square x 1" (25mm) Bit | 10-PC. POLYBAG/UPC | 1000 | 100 |
| 2852 | #3 Square x 1" (25mm) Bit | 10-PC. POLYBAG/UPC | 1000 | 100 |
| 2853 | Sd-15 x 1" (25mm) Star Drive Bit | 10-PC. POLYBAG/UPC | 1000 | 100 |
| 2854 | Sd-20 x 1" (25mm) Star Drive Bit | 10-PC. POLYBAG/UPC | 1000 | 100 |
| 2855 | 3/16" Flat x 1" (25mm) Bit | 10-PC. POLYBAG/UPC | 1000 | 100 |
| 2856 | 1/4" Flat x 1" (25mm) Bit | 10-PC. POLYBAG/UPC | 1000 | 100 |
| 2857 | #0 Phillips x 1" (25mm) Bit | 10-PC. POLYBAG/UPC | 1000 | 100 |
| 2858 | #1 Phillips x 1" (25mm) Bit | 10-PC. POLYBAG/UPC | 1000 | 100 |
| 2859 | #3 Phillips x 1" (25mm) Bit | 10-PC. POLYBAG/UPC | 1000 | 100 |
| 2878 | #2 Drywall x 1" (25mm) Bit | 10-PC. POLYBAG/UPC | 1000 | 100 |
| 2921 | #2 Phillips x 1" (25mm) Bit | 10-PC. POLYBAG/UPC | 1000 | 100 |

2" (50mm) BITS

| Item | Description | Packaging | Cs | In |
|------|-----------------------------|--------------------|------|-----|
| 2860 | #1 Square x 2" (50mm) Bit | 10-PC. POLYBAG/UPC | 1000 | 100 |
| 2861 | #2 Square x 2" (50mm) Bit | 10-PC. POLYBAG/UPC | 1000 | 100 |
| 2862 | #3 Square x 2" (50mm) Bit | 10-PC. POLYBAG/UPC | 1000 | 100 |
| 2863 | 3/16" Flat x 2" (50mm) Bit | 10-PC. POLYBAG/UPC | 1000 | 100 |
| 2864 | 1/4" Flat x 2" (50mm) Bit | 10-PC. POLYBAG/UPC | 1000 | 100 |
| 2865 | #0 Phillips x 2" (50mm) Bit | 10-PC. POLYBAG/UPC | 1000 | 100 |
| 2866 | #1 Phillips x 2" (50mm) Bit | 10-PC. POLYBAG/UPC | 1000 | 100 |
| 2867 | #3 Phillips x 2" (50mm) Bit | 10-PC. POLYBAG/UPC | 1000 | 100 |
| 2922 | #2 Phillips x 2" (50mm) Bit | 10-PC. POLYBAG/UPC | 1000 | 100 |

2-1/2" (65mm) DOUBLE-END BITS

| Item | Description | Packaging | Cs | In |
|------|--|--------------------|------|-----|
| 2868 | #2 Square x 2-1/2" (65mm) Double-End Bit | 10-PC. POLYBAG/UPC | 1000 | 100 |
| 2879 | #2 Drywall x 2-1/2" (65mm) Double-End Bit | 10-PC. POLYBAG/UPC | 1000 | 100 |
| 2923 | #2 Phillips x 2-1/2" (65mm) Double-End Bit | 10-PC. POLYBAG/UPC | 1000 | 100 |
| 2924 | #2 Phillips x 1/4" Flat x 2-1/2" (65mm) Double-End Bit | 10-PC. POLYBAG/UPC | 1000 | 100 |

6" (150mm) BITS

| Item | Description | Packaging | Cs | In |
|------|------------------------------|--------------------|-----|----|
| 2871 | 3/16" Flat x 6" (150mm) Bit | 10-PC. POLYBAG/UPC | 500 | 10 |
| 2872 | 1/4" Flat x 6" (150mm) Bit | 10-PC. POLYBAG/UPC | 500 | 10 |
| 2874 | #1 Phillips x 6" (150mm) Bit | 10-PC. POLYBAG/UPC | 500 | 10 |
| 2876 | #2 Phillips x 6" (150mm) Bit | 10-PC. POLYBAG/UPC | 500 | 10 |
| 2877 | #3 Phillips x 6" (150mm) Bit | 10-PC. POLYBAG/UPC | 500 | 10 |

1" (25mm) DIMPLE BIT

| Item | Description | Packaging | Cs | In |
|------|------------------------------|--------------------|------|-----|
| 2920 | #2 Drywall Dimple Driver Bit | 10-PC. POLYBAG/UPC | 1000 | 100 |

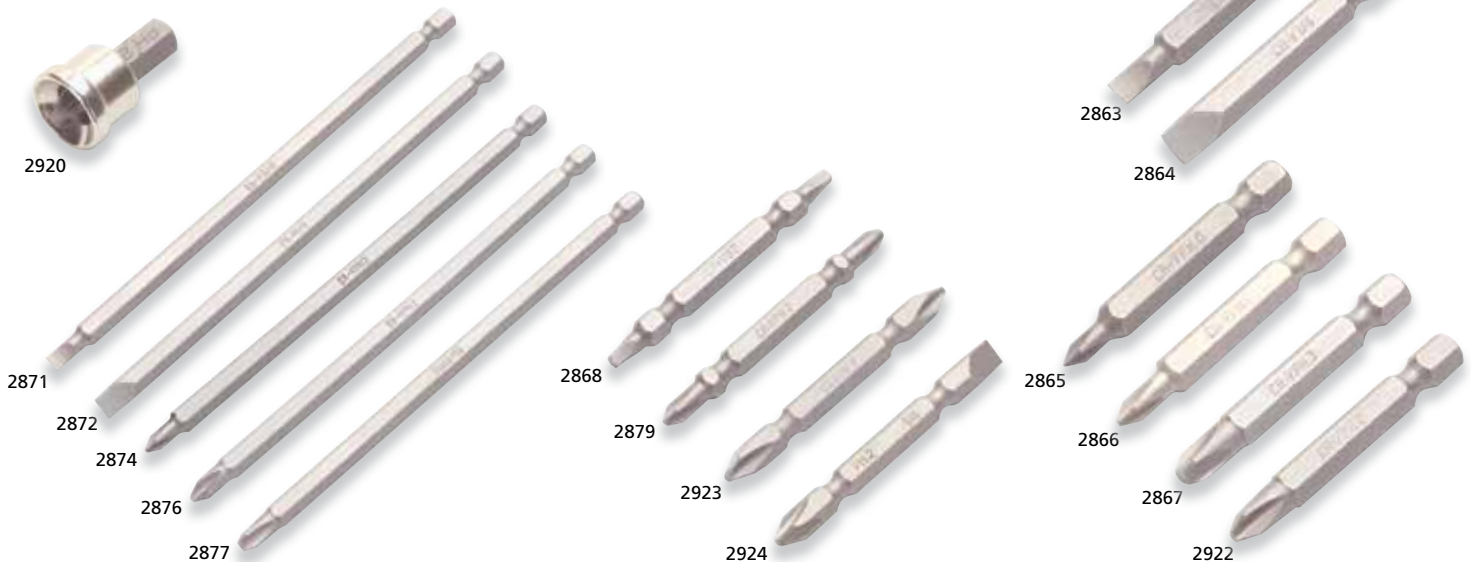



5-oz. Magnetic Tack Hammer

- Drop Forged, Heat Treated Steel Head
- Strong Magnetic Claw Holds Tacks and Nails
- Rugged Contoured Hardwood Handle
- Flat Face for Driving Tacks, Nails and Brads
- Steel Wedge Locks Head to Handle

| Item | Description | Packaging | Cs | In |
|------|----------------------------|------------------|----|----|
| 3010 | 5-oz. Magnetic Tack Hammer | BULK/COLOR LABEL | 72 | 12 |



8-oz. Wood Claw Hammer

- Solid Cast Steel Head with Semi-Polished, Lacquer-Coated Finish
- Full Size Round Striking Face
- Beveled-End Curved Claw
- Contoured Hardwood Handle
- Epoxy Bond Locks Head to Handle

| Item | Description | Packaging | Cs | In |
|------|------------------------|------------------|----|----|
| 3013 | 8-oz. Wood Claw Hammer | BULK/COLOR LABEL | 60 | 6 |



16-oz. Wood Hammers

Claw

- Drop Forged, Heat Treated Steel Head with Polished, Lacquer-Coated Finish
- Full Size Round Striking Face
- Beveled-End Curved Claw
- Contoured Hardwood Handle
- Epoxy Bond Locks Head to Handle

Rip

- Drop Forged, Heat Treated Steel Head with Polished, Lacquer-Coated Finish
- Full Size Round Striking Face
- Beveled-End Straight Rip Claw
- Contoured Hardwood Handle
- Epoxy Bond Locks Head to Handle

| Item | Description | Packaging | Cs | In |
|------|-------------------------|------------------|----|----|
| 3020 | 16-oz. Wood Claw Hammer | BULK/COLOR LABEL | 36 | 6 |
| 3030 | 16-oz. Wood Rip Hammer | BULK/COLOR LABEL | 36 | 6 |



16-oz. Hickory Claw Hammer

- Drop Forged, Heat Treated Steel Head
- Full Size Round Face for Accurate Striking
- Fully Polished, Lacquer Coated Head
- Beveled-End Curved Claw
- Rugged American Hickory Handle
- Epoxy Bond Locks Head to Handle

| Item | Description | Packaging | Cs | In |
|------|----------------------------|------------------|----|----|
| 3028 | 16-oz. Hickory Claw Hammer | BULK/COLOR LABEL | 36 | 6 |



8-oz. Tubular Steel Claw Hammer

- Solid Cast Steel Head with Semi-Polished, Lacquer-Coated Finish
- Full Size Round Striking Face
- Beveled-End Curved Claw
- Tubular Steel Handle with Cushioned Non-Slip Grip

| Item | Description | Packaging | Cs | In |
|------|---------------------------------|------------------|----|----|
| 3016 | 8-oz. Tubular Steel Claw Hammer | BULK/COLOR LABEL | 60 | 12 |

16-oz. Tubular Steel Hammers

Claw

- Drop Forged, Heat Treated Steel Head with Polished, Lacquer-Coated Finish
- Full Size Round Striking Face
- Beveled-End Curved Claw
- Rugged Tubular Steel Handle with Non-Slip Rubber Grip

Rip

- Drop Forged, Heat Treated Steel Head with Polished, Lacquer-Coated Finish
- Full Size Round Striking Face
- Beveled-End Straight Rip Claw
- Rugged Tubular Steel Handle with Non-Slip Rubber Grip

| Item | Description | Packaging | Cs | In |
|------|----------------------------------|------------------|----|----|
| 3048 | 16-oz. Tubular Steel Claw Hammer | BULK/COLOR LABEL | 36 | 6 |
| 3049 | 16-oz. Tubular Steel Rip Hammer | BULK/COLOR LABEL | 24 | 6 |



16-oz. Fiberglass Hammers

Claw

- Drop Forged, Heat Treated Steel Head with Polished, Lacquer-Coated Finish
- Full Size Round Striking Face
- Beveled-End Curved Claw
- Rugged 50% Fiberglass Handle with Non-Slip Rubber Grip
- Epoxy Bond Locks Head to Handle

Rip

- Drop Forged, Heat Treated Steel Head with Polished, Lacquer-Coated Finish
- Full Size Round Striking Face
- Beveled-End Straight Rip Claw
- Rugged 50% Fiberglass Handle with Non-Slip Rubber Grip
- Epoxy Bond Locks Head to Handle

| Item | Description | Packaging | Cs | In |
|------|-------------------------------|------------------|----|----|
| 3042 | 16-oz. Fiberglass Claw Hammer | BULK/COLOR LABEL | 36 | 6 |
| 3044 | 16-oz. Fiberglass Rip Hammer | BULK/COLOR LABEL | 36 | 6 |



16-oz. Fiberglass Hammers

Claw

- Drop Forged, Heat Treated Steel Head with Polished, Lacquer-Coated Finish
- Full Size Round Striking Face
- Beveled-End Curved Claw
- Rugged 35% Fiberglass Handle with Non-Slip Rubber Grip
- Epoxy Bond Locks Head to Handle

Rip

- Drop Forged, Heat Treated Steel Head with Polished, Lacquer-Coated Finish
- Full Size Round Striking Face
- Beveled-End Straight Rip Claw
- Rugged 35% Fiberglass Handle with Non-Slip Rubber Grip
- Epoxy Bond Locks Head to Handle

| Item | Description | Packaging | Cs | In |
|------|-------------------------------|------------------|----|----|
| 3040 | 16-oz. Fiberglass Claw Hammer | BULK/COLOR LABEL | 36 | 6 |
| 3045 | 16-oz. Fiberglass Rip Hammer | BULK/COLOR LABEL | 36 | 6 |

Jacketed Fiberglass Claw and Rip Hammers

Claw

- Drop Forged, Heat Treated Steel Head with Polished, Lacquer-Coated Finish
- Full Size Round Striking Face
- Beveled-End Curved Claw
- Jacketed Fiberglass Handle Protects Against Overstrikes
- Cushioned Non-Slip Rubber Handle Grip
- Contractor Grade - Meets or Exceeds ANSI Spec. B173.1

Rip

- Drop Forged, Heat Treated Steel Head with Polished, Lacquer-Coated Finish
- Full Size Round Striking Face
- Beveled-End Straight Rip Claw
- Jacketed Fiberglass Handle Protects Against Overstrikes
- Cushioned Non-Slip Rubber Handle Grip
- Contractor Grade - Meets or Exceeds ANSI Spec. B173.1

| Item | Description | Packaging | Cs | In |
|------|--|------------------|----|----|
| 3055 | 16-oz. Jacketed Fiberglass Claw Hammer | BULK/COLOR LABEL | 36 | 6 |
| 3056 | 16-oz. Jacketed Fiberglass Rip Hammer | BULK/COLOR LABEL | 36 | 6 |
| 3057 | 20-oz. Jacketed Fiberglass Claw Hammer | BULK/COLOR LABEL | 24 | 6 |
| 3058 | 20-oz. Jacketed Fiberglass Rip Hammer | BULK/COLOR LABEL | 24 | 6 |
| 3059 | 24-oz. Jacketed Fiberglass Rip Hammer | BULK/COLOR LABEL | 24 | 6 |





24-oz. Hickory-Handle Framing Hammer

- Drop Forged, Heat Treated Steel
- Rugged American Hickory Handle
- Mirror Polished, Lacquer Coated Head
- Precision-Milled Face Grips Nails
- Dual Steel Wedge System Locks Head to Handle
- Meets or Exceeds ANSI Spec. B173.1

| Item | Description | Packaging | Cs | In |
|------|--------------------------------------|------------------|----|----|
| 3066 | 24-oz. Hickory-Handle Framing Hammer | BULK/COLOR LABEL | 24 | 6 |



24-oz. Wood-Handle Framing Hammer

- Drop Forged, Heat Treated Steel
- Rugged Hardwood Handle
- Mirror Polished, Lacquer Coated Head
- Precision-Milled Face Grips Nails
- Epoxy Bond Locks Head to Handle

| Item | Description | Packaging | Cs | In |
|------|-----------------------------------|------------------|----|----|
| 3069 | 24-oz. Wood-Handle Framing Hammer | BULK/COLOR LABEL | 24 | 6 |



Wood Ball Pein Hammers

- Drop Forged, Heat Treated Steel Head
- Precision-Machined Face and Pein
- Semi-Polished, Lacquer Coated Head
- Rugged Contoured Hardwood Handle
- Epoxy Bond Locks Head to Handle

| Item | Description | Packaging | Cs | In |
|------|------------------------------|------------------|----|----|
| 3091 | 8-oz. Wood Ball Pein Hammer | BULK/COLOR LABEL | 72 | 6 |
| 3092 | 12-oz. Wood Ball Pein Hammer | BULK/COLOR LABEL | 60 | 6 |



4-pc. Fiberglass Ball Pein Hammer Set

- Drop Forged, Heat Treated Steel Heads
- Durable Polished and Lacquer-Coated Finish
- Epoxy Bonded Fiberglass Handles
- Textured Non-Slip Rubber Handle Grips
- 1-pc. 8-oz.
- 1-pc. 12-oz.
- 1-pc. 16-oz.
- 1-pc. 24-oz.

| Item | Description | Packaging | Cs | In |
|------|---------------------------------------|-----------|----|----|
| 3080 | 4-pc. Fiberglass Ball Pein Hammer Set | COLOR BOX | 8 | 1 |



Fiberglass Ball Pein Hammers

- Drop Forged, Heat Treated Steel Head
- Precision-Machined Face and Pein
- Semi-Polished, Lacquer Coated Head
- Fiberglass Handle for Sure Strength
- Cushioned Textured Non-Slip Rubber Handle Grip
- Epoxy Bond Locks Head to Handle

| Item | Description | Packaging | Cs | In |
|------|------------------------------------|------------------|----|----|
| 3081 | 8-oz. Fiberglass Ball Pein Hammer | BULK/COLOR LABEL | 48 | 6 |
| 3082 | 12-oz. Fiberglass Ball Pein Hammer | BULK/COLOR LABEL | 48 | 6 |
| 3083 | 16-oz. Fiberglass Ball Pein Hammer | BULK/COLOR LABEL | 36 | 6 |
| 3084 | 24-oz. Fiberglass Ball Pein Hammer | BULK/COLOR LABEL | 24 | 6 |
| 3086 | 32-oz. Fiberglass Ball Pein Hammer | BULK/COLOR LABEL | 12 | 4 |
| 3087 | 48-oz. Fiberglass Ball Pein Hammer | BULK/COLOR LABEL | 12 | 4 |

Machinist Hammers

3094

- Drop Forged, Heat Treated Steel Head
- Square and Tapered Striking Faces
- Fully Polished Head
- Rugged Contoured Hardwood Handle
- Steel Wedge Locks Head to Handle

3099

- Drop Forged, Heat Treated Steel Head
- Square and Tapered Striking Faces
- Fully Polished Head
- Rugged Contoured Hardwood Handle
- Epoxy Bond Locks Head to Handle

3112

- Drop Forged, Heat Treated Steel Head
- Fully Polished Head
- Square and Tapered Striking Faces
- Rugged 50% Fiberglass Handle
- Cushioned Textured Non-Slip Rubber Grip
- Epoxy Bond Locks Head to Handle

| Item | Description | Packaging | Cs | In |
|------|-----------------------------------|------------------|----|----|
| 3094 | 8-oz. Machinist Hammer | BULK/COLOR LABEL | 60 | 6 |
| 3099 | 3-lb. Machinist Hammer | BULK/COLOR LABEL | 12 | 6 |
| 3112 | 3-lb. Fiberglass Machinist Hammer | BULK/COLOR LABEL | 16 | 4 |



Cross Pein Hammers

- Drop Forged, Heat Treated Steel Head
- Precision-Machined Face and Pein
- Polished Face
- Rugged Contoured Hardwood Handle
- Epoxy Bond Locks Head to Handle

| Item | Description | Packaging | Cs | In |
|------|-------------------------|------------------|----|----|
| 3097 | 3-lb. Cross Pein Hammer | BULK/COLOR LABEL | 12 | 4 |
| 3098 | 4-lb. Cross Pein Hammer | BULK/COLOR LABEL | 12 | 6 |



Drilling Hammers

3100

- Drop Forged, Heat Treated Steel Head
- Round, Polished Striking Surfaces
- Rugged Contoured Hardwood Handle
- Epoxy Bond Locks Head to Handle

3101

- Drop Forged, Heat Treated Steel Head
- Round, Polished Striking Surfaces
- Rugged Contoured Hardwood Handle
- Epoxy Bond Locks Head to Handle

3108

- Drop Forged, Heat Treated Steel Head
- Fully Polished Head
- Square, Polished Striking Faces
- Rugged 50% Fiberglass Handle
- Cushioned Textured Non-Slip Rubber Grip
- Epoxy Bond Locks Head to Handle

| Item | Description | Packaging | Cs | In |
|------|----------------------------------|------------------|----|----|
| 3100 | 2-lb. Drilling Hammer | BULK/COLOR LABEL | 24 | 6 |
| 3101 | 3-lb. Drilling Hammer | BULK/COLOR LABEL | 12 | 4 |
| 3108 | 3-lb. Fiberglass Drilling Hammer | BULK/COLOR LABEL | 16 | 4 |



Sledge Hammers

3103

- Drop Forged, Heat Treated Steel Head
- Round, Polished Striking Surfaces
- Rugged Contoured Hardwood Handle
- Epoxy Bond Locks Head to Handle

3104

- Drop Forged, Heat Treated Steel Head
- Round, Polished Striking Surfaces
- Rugged Contoured Hardwood Handle
- Epoxy Bond Locks Head to Handle

3110

- Drop Forged, Heat Treated Steel Head
- Fully Polished Head
- Square, Polished Striking Faces
- Rugged 50% Fiberglass Handle
- Cushioned Textured Non-Slip Rubber Grip
- Epoxy Bond Locks Head to Handle

| Item | Description | Packaging | Cs | In |
|------|--------------------------------|------------------|----|----|
| 3103 | 3-lb. Sledge Hammer | BULK/COLOR LABEL | 12 | 4 |
| 3104 | 4-lb. Sledge Hammer | BULK/COLOR LABEL | 12 | 4 |
| 3110 | 3-lb. Fiberglass Sledge Hammer | BULK/COLOR LABEL | 16 | 4 |





3-pc. Rubber Mallet Set

- Double-Faced Solid Rubber Heads
- Rugged Natural Hardwood Handles
- General-Purpose Non-Marring Mallets for Sheet Metal Fabrication, Automotive Repairs, and Construction Applications
- 1-pc. 8-oz. (1-3/4" Dia.)
- 1-pc. 16-oz. (2-1/4" Dia.)
- 1-pc. 32-oz. (2-5/8" Dia.)

| Item | Description | Packaging | Cs | In |
|------|-------------------------|-----------|----|----|
| 3161 | 3-pc. Rubber Mallet Set | COLOR BOX | 12 | 1 |



Rubber Mallets

- Double-Faced Solid Rubber Head
- Round Striking Surfaces
- Rugged Hardwood Handle

| Item | Description | Packaging | Cs | In |
|------|----------------------|------------------|----|----|
| 3172 | 8-oz. Rubber Mallet | BULK/COLOR LABEL | 36 | 4 |
| 3174 | 16-oz. Rubber Mallet | BULK/COLOR LABEL | 36 | 4 |
| 3168 | 24-oz. Rubber Mallet | BULK/COLOR LABEL | 24 | 6 |
| 3169 | 32-oz. Rubber Mallet | BULK/COLOR LABEL | 16 | 4 |



8-oz. Rubber Mallet

- Double-Faced Solid Rubber Head
- 2" Round Striking Surfaces
- Rugged Tubular Steel Handle
- Cushioned Textured Non-Slip Handle Grip

| Item | Description | Packaging | Cs | In |
|------|---------------------|------------------|----|----|
| 3164 | 8-oz. Rubber Mallet | BULK/COLOR LABEL | 36 | 3 |



16-oz. White Rubber Mallet

- Double-Faced Solid Rubber Head
- 2-1/4" Round Striking Surfaces
- White Rubber will not Mark Surfaces
- Rugged Tubular Steel Handle
- Cushioned Textured Non-Slip Handle Grip

| Item | Description | Packaging | Cs | In |
|------|----------------------------|------------------|----|----|
| 3165 | 16-oz. White Rubber Mallet | BULK/COLOR LABEL | 36 | 4 |



16-oz. Fiberglass Rubber Mallet

- Double-Faced Solid Rubber Head
- 2-1/4" Round Striking Surfaces
- Rugged Fiberglass Handle
- Cushioned Textured Non-Slip Handle Grip

| Item | Description | Packaging | Cs | In |
|------|---------------------------------|------------------|----|----|
| 3166 | 16-oz. Fiberglass Rubber Mallet | BULK/COLOR LABEL | 24 | 4 |

Double-Face Soft Mallets

3176

- Two 20mm Diameter Replaceable Heads: Black Rubber Head for a Cushioned Strike, High Impact Plastic Head For a Positive Strike
- Rugged Contoured Hardwood Handle

3179

- Two 35mm Diameter Replaceable Heads: Black Rubber Head for a Cushioned Strike, High Impact Plastic Head For a Positive Strike
- Rugged Tubular Steel Handle
- Cushioned Non-Slip Rubber Handle Grip

3180

- Two 40mm Diameter Replaceable Heads: Black Rubber Head for a Cushioned Strike, High Impact Plastic Head For a Positive Strike
- Rugged Tubular Steel Handle
- Cushioned Non-Slip Rubber Handle Grip

| Item | Description | Packaging | Cs | In |
|------|-------------------------|------------------|-----|----|
| 3176 | Double-Face Soft Mallet | BULK/COLOR LABEL | 120 | 6 |
| 3179 | Double-Face Soft Mallet | BULK/COLOR LABEL | 48 | 6 |
| 3180 | Double-Face Soft Mallet | BULK/COLOR LABEL | 36 | 6 |



Fiberglass Brass Hammers

- Precision-Machined Solid Brass Head
- Non-Sparking Head will not Mar Finished Steel Surfaces
- Mirror-Polished, Lacquer-Coated Head
- Rugged 50% Fiberglass Jacketed Handle

| Item | Description | Packaging | Cs | In |
|------|--------------------------------|------------------|----|----|
| 3190 | 16-oz. Fiberglass Brass Hammer | BULK/COLOR LABEL | 24 | 4 |
| 3191 | 24-oz. Fiberglass Brass Hammer | BULK/COLOR LABEL | 24 | 4 |
| 3192 | 32-oz. Fiberglass Brass Hammer | BULK/COLOR LABEL | 16 | 4 |



Fiberglass Copper Hammers

- Precision-Machined Solid Copper Head
- Non-Sparking Head will not Mar Finished Steel Surfaces
- Mirror-Polished, Lacquer-Coated Head
- Rugged Jacketed Fiberglass Handle

| Item | Description | Packaging | Cs | In |
|------|---------------------------------|------------------|----|----|
| 3194 | 16-oz. Fiberglass Copper Hammer | BULK/COLOR LABEL | 36 | 4 |
| 3195 | 32-oz. Fiberglass Copper Hammer | BULK/COLOR LABEL | 16 | 2 |
| 3196 | 48-oz. Fiberglass Copper Hammer | BULK/COLOR LABEL | 12 | 2 |
| 3197 | 64-oz. Fiberglass Copper Hammer | BULK/COLOR LABEL | 10 | 2 |

Deadblow Hammers

- Steel Shot-Filled Head Adds Extra Force to Hammer Blows and Eliminates Rebound
- Steel Handle Encased in High-Impact, Rubberized Plastic to Prevent Marring
- Diamond Textured Non-Slip Handle

| Item | Description | Packaging | Cs | In |
|------|------------------------|------------------|----|----|
| 3182 | 16-oz. Deadblow Hammer | BULK/COLOR LABEL | 24 | 4 |
| 3183 | 24-oz. Deadblow Hammer | BULK/COLOR LABEL | 24 | 4 |
| 3184 | 32-oz. Deadblow Hammer | BULK/COLOR LABEL | 24 | 4 |
| 3188 | 48-oz. Deadblow Hammer | BULK/COLOR LABEL | 12 | 3 |





8-oz. Chipping Hammer

- Drop Forged, Heat Treated Steel Head
- Full Solid Steel Shaft
- Shock-Dampening Spring Handle
- Double-End Head Features 7/8" Chisel End and Slag Remover End
- Specially Designed for Welding Applications

| Item | Description | Packaging | Cs | In |
|------|-----------------------|------------------|----|----|
| 3079 | 8-oz. Chipping Hammer | BULK/COLOR LABEL | 36 | 6 |



Drywall Hammer

- Drop Forged, Heat Treated Steel Head
- Round Milled, Mesh Patterned Hammer Face
- Hatchet End for Chipping and Cutting Plaster and Drywall
- Mirror Polished, Lacquer Coated Head
- Rugged Hardwood Handle
- Dual Steel Wedge System Locks Head to Handle

| Item | Description | Packaging | Cs | In |
|------|----------------|------------------|----|----|
| 3072 | Drywall Hammer | BULK/COLOR LABEL | 24 | 6 |



Shingle Hatchet

- Drop Forged, Heat Treated Steel Head
- Square Precision-Milled Mesh Patterned Face
- Sharpened Hatchet End
- Mirror Polished, Lacquer Coated Head
- Rugged Solid American Hickory Handle
- Dual Steel Wedge System Locks Head to Handle
- Wrist Lanyard Prevents Dropping Tool

| Item | Description | Packaging | Cs | In |
|------|-----------------|------------------|----|----|
| 3073 | Shingle Hatchet | BULK/COLOR LABEL | 24 | 2 |



Felling Axes

- Drop Forged, Heat Treated Steel Head
- Rugged Contoured Hardwood Handle
- Epoxy Wedge Locks Head to Handle

| Item | Description | Packaging | Cs | In |
|------|-----------------------|------------------|----|----|
| 3240 | 1-1/4 lb. Felling Axe | BULK/COLOR LABEL | 24 | 6 |
| 3245 | 2 lb. Felling Axe | BULK/COLOR LABEL | 24 | 6 |
| 3250 | 2-1/2 lb. Felling Axe | BULK/COLOR LABEL | 12 | 6 |



Camp Axes

3280

- Drop Forged, Heat Treated Steel Head
- Fully Polished Head
- Rugged Tubular Steel Handle
- Cushioned Non-Slip Rubber Handle Grip
- 13" Overall Length

3283

- Drop Forged, Heat Treated Steel Head
- Fully Polished Head
- 50% Fiberglass Handle for Sure Strength
- Cushioned Non-Slip Rubber Handle Grip
- 13-1/4" Overall Length

| Item | Description | Packaging | Cs | In |
|------|--------------------------------|------------------|----|----|
| 3280 | 20-oz. Tubular Handle Camp Axe | BULK/COLOR LABEL | 36 | 6 |
| 3283 | 20-oz. Fiberglass Camp Axe | BULK/COLOR LABEL | 24 | 6 |



Tack Puller

- Drop Forged, Heat Treated Carbon Steel Blade
- Contoured Square Handle for Sure Grip
- "V"-Slot Angled Chisel Tip
- Pulls Stubborn Tacks, Brads and Staples
- 4" Blade Length, 7-1/2" Overall Length

| Item | Description | Packaging | Cs | In |
|------|-------------|--------------------|-----|----|
| 3304 | Tack Puller | SLIDE BLISTER CARD | 100 | 10 |



Utility Pry Bars

- Rugged Hardened and Tempered Steel
- Durable, Baked Enamel Finish
- Three Nail Slots: One in Center, One at Each End
- Beveled, Sharpened Ends Slide into Tight Spots
- Flat End for Heavy Duty Prying
- Rocker Hook End for Extra Leverage and Use in Confined Areas

| Item | Description | Packaging | Cs | In |
|------|------------------------|------------------|-----|----|
| 3305 | 7-1/2" Utility Pry Bar | BULK/COLOR LABEL | 240 | 12 |
| 3318 | 15" Utility Pry Bar | BULK/COLOR LABEL | 36 | 6 |
| 3320 | 18" Utility Pry Bar | BULK/COLOR LABEL | 36 | 6 |



11" Nail Claw

- Drop Forged Hardened Steel Construction
- Made from Solid Hex Bar Stock
- Non-Slip Cushioned Handle Grip
- 90° Angle Paw with Deep-"V" Nail Slot

| Item | Description | Packaging | Cs | In |
|------|---------------|------------------|----|----|
| 3310 | 11" Nail Claw | BULK/COLOR LABEL | 60 | 6 |



Wrecking Bars

- Drop Forged Hardened Steel Construction
- Made from Solid Hex Bar Stock
- Flat End for Prying and Lifting
- High-Leverage Hook End with Deep-"V" Nail Slot
- Durable Enamel Finish

| Item | Description | Packaging | Cs | In |
|------|------------------|------------------|----|----|
| 3323 | 12" Wrecking Bar | BULK/COLOR LABEL | 48 | 6 |
| 3324 | 18" Wrecking Bar | BULK/COLOR LABEL | 24 | 6 |



2-pc. Rolling Head Pry Bar Set

- Drop Forged Hardened Steel Construction
- Slim Tapered End with Fine Point Tip for Aligning Parts
- Rolling Head Hook End Delivers Maximum Leverage
- Durable Baked Enamel Finish

- 2-pc. Pry Bars: 12", 16"

| Item | Description | Packaging | Cs | In |
|------|--------------------------------|-----------------------|----|----|
| 3344 | 2-pc. Rolling Head Pry Bar Set | SEALED BLISTER - FULL | 24 | 4 |



4-pc. Rolling Head Pry Bar Set

- Drop Forged Hardened Steel Construction
- Slim Tapered End with Fine Point Tip for Aligning Parts
- Rolling Head Hook End Delivers Maximum Leverage
- Durable Baked Enamel Finish

- 4-pc. Pry Bars: 6", 12", 16", 20"

| Item | Description | Packaging | Cs | In |
|------|--------------------------------|-----------------------|----|----|
| 3346 | 4-pc. Rolling Head Pry Bar Set | SEALED BLISTER - FULL | 12 | 6 |



5-pc. Mechanic's Pry Bar Set

Mechanic's Pry Bars

- Rugged Hardened Square Stock Steel Shafts
- Durable Black Oxide Finish
- Sharpened, Beveled-End Angled Tips Slip into Tight Spots
- Oversized Mechanic's-Style Handles for Sure Grip

Rolling Head Pry Bar

- Drop Forged Hardened Steel Construction
- Slim Tapered End with Fine Point Tip for Aligning Parts
- Rolling Head Hook End Delivers Maximum Leverage
- Durable Baked Enamel Finish

- 4-pc. Pry Bars: 8", 12", 18", 24"
- 1-pc. Rolling Head Pry Bar: 16"

| Item | Description | Packaging | Cs | In |
|------|------------------------------|--------------------|----|----|
| 3350 | 5-pc. Mechanic's Pry Bar Set | SLIDE BLISTER CARD | 10 | 2 |



Mechanic's Pry Bars

- Rugged Hardened Square Stock Steel Shafts
- Durable Black Oxide Finish
- Sharpened, Bevel-End Angled Tips Slip into Tight Spots
- Oversized Countoured Handles for Sure Grip

3352

- 4-pc. Mechanic's Pry Bars: 8", 12", 18", 24"

| Item | Description | Packaging | Cs | In |
|------|------------------------------|-----------------------|----|----|
| 3352 | 4-pc. Mechanic's Pry Bar Set | SEALED BLISTER - FULL | 12 | 4 |
| 3358 | 12" Mechanic's Pry Bar | BULK/COLOR LABEL | 48 | 6 |
| 3359 | 18" Mechanic's Pry Bar | BULK/COLOR LABEL | 48 | 6 |
| 3360 | 24" Mechanic's Pry Bar | BULK/COLOR LABEL | 36 | 6 |



36" Jumbo Go-Through Pry Bars

3362

- Heat Treated Chrome Molybdenum Steel 5/8" Square Stock Shaft
- 30° Bent Tip for Extra Leverage
- Oversized Two-Hand Round Handle with Non-Slip Rubber Grips
- Handle Strike Plate for Driving into Tight Spaces

3363

- Heat Treated Chrome Molybdenum Steel 5/8" Square Stock Shaft
- Straight Tip for Extra Reach into Tight Spaces
- Oversized Two-Hand Round Handle with Non-Slip Rubber Grips
- Handle Strike Plate for Driving into Tight Spaces

| Item | Description | Packaging | Cs | In |
|------|---|------------------|----|----|
| 3362 | 36" Jumbo Go-Through Bent Tip Pry Bar | BULK/COLOR LABEL | 10 | 5 |
| 3363 | 36" Jumbo Go-Through Straight Tip Pry Bar | BULK/COLOR LABEL | 10 | 5 |



4-pc. Pry Bar Set

- Designed to Allow Hammer Striking for Positioning in Tight Spaces
- Large Striking Area with Hand Guard Protects Against Overstrikes
- Comfortable Oversized Handle with Non-Slip, Cushioned Grip
- Square Stock, Fully Hardened, Alloy Steel Shaft
- Precision-Ground, Beveled-End, Angled Tip Slips into Tight Spaces

- 4-pc. Pro-Guard Pry Bars: 8", 12", 18", 24"

| Item | Description | Packaging | Cs | In |
|------|-------------------|-----------------------|----|----|
| 3353 | 4-pc. Pry Bar Set | SEALED BLISTER - FULL | 6 | 2 |

Bolt Cutters

- Drop Forged Hardened Alloy Steel Jaws
- Compound Cutting Action Requires Less Effort
- Tubular Steel Handles with Cushioned Non-Slip Rubber Grips
- Adjustable and Replaceable Jaws
- Cuts Bolts, Chain, Threaded Rod, and More

3386

- Drop Forged Hardened Alloy Steel Jaws
- Compound Cutting Action Requires Less Effort
- Rolled Steel Handles with Cushioned Non-Slip Rubber Grips
- Cuts Bolts, Chain, Threaded Rod, and More

| Item | Description | Packaging | Cs | In |
|------|-----------------|----------------------|----|----|
| 3386 | 8" Bolt Cutter | COLOR POLY HANG CARD | 36 | 6 |
| 3388 | 12" Bolt Cutter | BULK/COLOR LABEL | 12 | 1 |
| 3391 | 14" Bolt Cutter | BULK/COLOR LABEL | 10 | 1 |
| 3400 | 18" Bolt Cutter | BULK/COLOR LABEL | 10 | 1 |
| 3410 | 24" Bolt Cutter | BULK/COLOR LABEL | 10 | 1 |
| 3416 | 30" Bolt Cutter | BULK/COLOR LABEL | 5 | 1 |
| 3421 | 36" Bolt Cutter | BULK/COLOR LABEL | 5 | 1 |



Slip Joint Pliers

- Drop Forged Heat Treated Steel Construction
- Precision-Machined Curved/Flat Combination Jaws
- Shear-Type Wire Cutter
- Corrosion-Resistant Chrome Plated Finish
- Cushioned Non-Slip Handle Grips
- Meets or Exceeds ANSI Specifications

3445

- 3-pc. Slip Joint Pliers: 6", 8", 10"

| Item | Description | Packaging | Cs | In |
|------|-----------------------------|-----------------------|-----|----|
| 3445 | 3-pc. Slip Joint Pliers Set | SEALED BLISTER - HALF | 25 | 5 |
| 3462 | 6" Slip Joint Pliers | COLOR POLY HANG CARD | 120 | 6 |
| 3467 | 8" Slip Joint Pliers | COLOR POLY HANG CARD | 60 | 6 |
| 3471 | 10" Slip Joint Pliers | COLOR POLY HANG CARD | 24 | 6 |



Groove Joint Pliers

- Drop Forged Heat Treated Steel Construction
- Precision-Milled Non-Slip Tongue and Groove Design Adjusts and Locks Jaw Capacity
- Durable Chrome Plated Finish
- Cushioned Non-Slip Handle Grips
- Meets or Exceeds ANSI Specifications

3583

- 1-pc. 6" Groove Joint Pliers
- 1-pc. 8" Groove Joint Pliers
- 1-pc. 10" Groove Joint Pliers
- 1-pc. 12" Groove Joint Pliers
- Complete w/PVC Roll-up Carrying Pouch

| Item | Description | Packaging | Cs | In |
|------|-------------------------------|-----------------------|-----|----|
| 3582 | 16" Groove Joint Pliers | COLOR POLY HANG CARD | 16 | 4 |
| 3583 | 4-pc. Groove Joint Pliers Set | SEALED BLISTER - HALF | 20 | 1 |
| 3586 | 6" Groove Joint Pliers | COLOR POLY HANG CARD | 120 | 6 |
| 3587 | 8" Groove Joint Pliers | COLOR POLY HANG CARD | 96 | 6 |
| 3588 | 10" Groove Joint Pliers | COLOR POLY HANG CARD | 60 | 6 |
| 3589 | 12" Groove Joint Pliers | COLOR POLY HANG CARD | 40 | 5 |

Long Nose Pliers

- Drop Forged Heat Treated Steel Construction
- Precision-Machined Long Nose Jaws
- Sharp, High Frequency Treated Wire Cutters
- Cushioned Non-Slip Handle Grips
- Meets or Exceeds ANSI Specifications

| Item | Description | Packaging | Cs | In |
|------|------------------------------|----------------------|----|----|
| 3507 | 6" Long Nose Pliers | COLOR POLY HANG CARD | 60 | 6 |
| 3511 | 8" Long Nose Pliers | COLOR POLY HANG CARD | 60 | 6 |
| 3517 | 6" 45° Bent Long Nose Pliers | COLOR POLY HANG CARD | 60 | 6 |
| 3518 | 8" 45° Bent Long Nose Pliers | COLOR POLY HANG CARD | 60 | 6 |
| 3520 | 6" 90° Bent Long Nose Pliers | COLOR POLY HANG CARD | 60 | 6 |



62 Pliers and Snips



Long Reach Pliers

- Drop Forged Heat Treated Carbon Steel
- Fully Polished Finish
- Precision-Machined Jaws
- Cushioned Non-Slip Handle Grips
- Long Reach Design for Tight Work Areas
- Meets or Exceeds ANSI Specifications

| Item | Description | Packaging | Cs | In |
|------|---|----------------------|----|----|
| 3490 | 11" Long Reach Long Nose Pliers | COLOR POLY HANG CARD | 60 | 6 |
| 3491 | 11" Long Reach 45° Bent Nose Pliers | COLOR POLY HANG CARD | 60 | 6 |
| 3492 | 11" Long Reach 90° Bent Nose Pliers | COLOR POLY HANG CARD | 60 | 6 |
| 3493 | 11" Long Reach 15° Bent Nose Pliers | COLOR POLY HANG CARD | 60 | 6 |
| 3494 | 11" Long Reach Duckbill Pliers | COLOR POLY HANG CARD | 60 | 6 |
| 3495 | 11" Long Reach Hose Ring Pliers | COLOR POLY HANG CARD | 60 | 6 |
| 3532 | 11" Long Reach Diagonal Cut Pliers | COLOR POLY HANG CARD | 60 | 6 |
| 3533 | 11" Long Reach 45° Offset Diagonal Cut Pliers | COLOR POLY HANG CARD | 60 | 6 |



Linesman Pliers

3536 - 3546

- Drop Forged Heat Treated Steel Construction
- Precision-Machined Upper and Lower Gripping Jaws
- Sharpened Wire Cutter
- Cushioned Non-Slip Handle Grips
- Meets or Exceeds ANSI Specifications

3548

- Professional Grade Drop Forged Heat Treated Steel Construction
- Precision-Machined Upper and Lower Gripping Jaws
- Sharpened Wire Cutter
- Wire and Terminal Crimper
- Cushioned Non-Slip Handle Grips
- Meets or Exceeds ANSI Specifications

| Item | Description | Packaging | Cs | In |
|------|--------------------------------|----------------------|----|----|
| 3536 | 6" Linesman Pliers | COLOR POLY HANG CARD | 60 | 6 |
| 3540 | 7" Linesman Pliers | COLOR POLY HANG CARD | 60 | 6 |
| 3546 | 8" Linesman Pliers | COLOR POLY HANG CARD | 60 | 6 |
| 3548 | 10" Heavy Duty Linesman Pliers | COLOR POLY HANG CARD | 36 | 6 |





End Nipper Pliers

- Drop Forged Heat Treated Steel Construction
- Precision-Machined Jaws
- Sharp High-Frequency Treated Cutting Edges
- Cushioned Non-Slip Handle Grips

| Item | Description | Packaging | Cs | In |
|------|----------------------|----------------------|----|----|
| 3525 | 6" End Nipper Pliers | COLOR POLY HANG CARD | 60 | 6 |
| 3530 | 8" End Nipper Pliers | COLOR POLY HANG CARD | 60 | 6 |



Diagonal Cut Pliers

- Drop Forged Heat Treated Steel Construction
- Precision-Machined Jaws
- Sharp High-Frequency Treated Cutting Edges
- Cushioned Non-Slip Handle Grips

| Item | Description | Packaging | Cs | In |
|------|----------------------------|----------------------|----|----|
| 3527 | 6" Diagonal Cut Pliers | COLOR POLY HANG CARD | 60 | 6 |
| 3531 | 7" Diagonal Cutting Pliers | COLOR POLY HANG CARD | 60 | 6 |

10" Fencing Pliers

- Drop Forged Heat Treated Steel Construction
- Precision-Machined Multi-Function Jaws
- Cushioned Non-Slip Handle Grips
- Seven Tools in One: Two Wire Splicing Crimpers, Milled Hammer Face, Staple Puller Claw, Two Shear-Type Wire Cutters, and Gripping Jaws

| Item | Description | Packaging | Cs | In |
|------|--------------------|----------------------|----|----|
| 3566 | 10" Fencing Pliers | COLOR POLY HANG CARD | 36 | 6 |



Precision Long Nose Pliers

- Drop Forged Heat Treated Steel Construction
- Spring-Loaded Self-Opening Hinge
- Cushioned Non-Slip Handle Grips
- Precision-Machined Jaws
- Sharp, High Frequency Treated Wire Cutters
- Meets or Exceeds ANSI Specifications

- | | |
|----------------------------|--------------------------|
| 3592 | 3596 |
| • 1-pc. Long Nose | • 1-pc. 4-3/4" Long Nose |
| • 1-pc. 45° Bent Long Nose | • 1-pc. 4-1/2" Diagonal |
| • 1-pc. Linesman | • 1-pc. 4-3/4" Bent Nose |
| • 1-pc. End Nipper | |
| • 1-pc. Diagonal Cut | |



| Item | Description | Packaging | Cs | In |
|------|-------------------------------------|-----------------------|-----|----|
| 3504 | Precision Needle Nose Pliers | COLOR POLY HANG CARD | 120 | 12 |
| 3506 | Precision Long Nose Pliers | COLOR POLY HANG CARD | 120 | 12 |
| 3516 | Precision 45° Bent Long Nose Pliers | COLOR POLY HANG CARD | 120 | 12 |
| 3522 | Precision End Nipper Pliers | COLOR POLY HANG CARD | 120 | 12 |
| 3526 | Precision Diagonal Cut Pliers | COLOR POLY HANG CARD | 120 | 12 |
| 3534 | Precision Linesman Pliers | COLOR POLY HANG CARD | 120 | 12 |
| 3592 | 5-pc. Precision Pliers Set | SEALED BLISTER - HALF | 30 | 5 |
| 3596 | 3-pc. Precision Pliers Set | SEALED BLISTER - HALF | 60 | 6 |



64 Pliers and Snips



Flex Grip Pliers

- Drop Forged, Fully Hardened Steel
- Precision-Machined Jaws
- Sharp, High Frequency Treated Wire Cutters
- Flex Grip Self-Opening Spring-Loaded Handles
- Cushioned Non-Slip Handle Grips
- Meets or Exceeds ANSI Specifications

| Item | Description | Packaging | Cs | In |
|-------|---------------------------------------|------------------------|----|----|
| 35072 | 6-1/2" Flex Grip Long Nose Pliers | PLASTIC HANG TAB/LABEL | 60 | 6 |
| 35073 | 8" Flex Grip Long Nose Pliers | PLASTIC HANG TAB/LABEL | 60 | 6 |
| 35074 | 6-1/2" Flex Grip 45° Bent Nose Pliers | PLASTIC HANG TAB/LABEL | 60 | 6 |
| 35075 | 8" Flex Grip 45° Bent Nose Pliers | PLASTIC HANG TAB/LABEL | 60 | 6 |
| 35076 | 6-1/2" Flex Grip Diagonal Cut Pliers | PLASTIC HANG TAB/LABEL | 60 | 6 |
| 35077 | 7-1/2" Flex Grip Diagonal Cut Pliers | PLASTIC HANG TAB/LABEL | 60 | 6 |
| 35078 | 8" Flex Grip Linesman Pliers | PLASTIC HANG TAB/LABEL | 60 | 6 |



3-pc. Utility Pliers Set

- Drop Forged, Heat Treated Steel Construction
- Precision-Machined Jaws with Polished Finish
- Cushioned Non-Slip Handle Grips
- Meets or Exceeds ANSI Specifications

- 1-pc. 6" Diagonal Cut Pliers
- 1-pc. 8" Linesman Pliers
- 1-pc. 8" Long Nose Pliers

| Item | Description | Packaging | Cs | In |
|------|--------------------------|-----------------------|----|----|
| 3552 | 3-pc. Utility Pliers Set | SEALED BLISTER - HALF | 20 | 5 |



3-pc. Utility Pliers Set

- Drop Forged, Heat Treated Steel Construction
- Precision-Machined Jaws
- Cushioned Non-Slip Handle Grips
- Meets or Exceeds ANSI Specifications

- 1-pc. 6" Slip Joint Pliers
- 1-pc. 8" Long Nose Pliers
- 1-pc. 10" Groove Joint Pliers

| Item | Description | Packaging | Cs | In |
|------|--------------------------|-----------------------|----|----|
| 3560 | 3-pc. Utility Pliers Set | SEALED BLISTER - HALF | 24 | 4 |

5-pc. Utility Pliers Set

- Drop Forged, Heat Treated Steel Construction
- Precision-Machined Jaws
- Cushioned Non-Slip Handle Grips
- General-Purpose Project Assortment for Auto, Garage, and Home

- 1-pc. 6" Diagonal Cut Pliers
- 1-pc. 8" Long Nose Pliers
- 1-pc. 8" Linesman Pliers
- 1-pc. 5-in-1 Combination Tool
- 1-pc. 10" Locking Pliers

| Item | Description | Packaging | Cs | In |
|------|--------------------------|-----------------------|----|----|
| 3557 | 5-pc. Utility Pliers Set | SEALED BLISTER - HALF | 20 | 1 |





Snap Ring Pliers

- Drop Forged, Heat Treated High-Carbon Steel
- Precision-Machined, Black Oxide Finished Tips
- Self-Opening Spring-Loaded Handles
- Cushioned Non-Slip Handle Grips

3576

- 1-pc. 6" Internal Bent Tip
- 1-pc. 6" Internal Straight Tip
- 1-pc. 6" External Bent Tip
- 1-pc. 6" External Straight Tip

| Item | Description | Packaging | Cs | In |
|------|---------------------------------------|-----------------------|----|----|
| 3571 | 7" Internal Bent Tip Snap Ring Pliers | COLOR POLY HANG CARD | 72 | 6 |
| 3572 | 7" External Bent Tip Snap Ring Pliers | COLOR POLY HANG CARD | 72 | 6 |
| 3573 | 7" Internal Snap Ring Pliers | COLOR POLY HANG CARD | 72 | 6 |
| 3574 | 7" External Snap Ring Pliers | COLOR POLY HANG CARD | 72 | 6 |
| 3576 | 4-pc. Heavy Duty Snap Ring Pliers | SEALED BLISTER - HALF | 30 | 5 |



8-in-1 Universal Snap Ring Pliers Set

- Heat Treated Carbon Steel Construction
- Corrosion-Resistant Black Oxide Finish
- Precision-Machined Tips
- Self-Opening, Spring-Loaded Handles
- Comfortable, Cushioned Non-Slip Grips
- Universal Internal/External Heads
- Size Range: Internal: 3/4" - 1-3/4", External: 1" - 2-1/2", Tip Size: .060"

- 2-pc. Straight Tip Heads
- 1-pc. 45° Bent Tip Head
- 1-pc. 90° Bent Tip Head
- 1-pc. Handle Assembly
- Complete with Storage Case

| Item | Description | Packaging | Cs | In |
|------|---------------------------------------|--------------------|----|----|
| 3578 | 8-in-1 Universal Snap Ring Pliers Set | PLASTIC CASE/LABEL | 24 | 6 |



6-in-1 Snap Ring Pliers Set

- Heat-Treated Carbon Steel Construction
- Corrosion-Resistant Black Oxide Finish
- Precision-Machined and Hardened Universal Interchangeable Tips
- Self-Opening, Spring-Loaded Handles
- Comfortable, Cushioned Non-Slip Grips
- Size Range: Internal: 1/4" - 1-3/4", External: 1/4" - 2-1/2", Tip Diameter: .040" and .050"

- 1-pc. External Pliers
- 1-pc. Internal Pliers
- 2-pc. Straight Tip (.040")
- 2-pc. Straight Tip (.050")
- 2-pc. 45° Bent Tip (.050")
- 2-pc. 90° Bent Tip (.050")
- Complete with Tip Storage Case

| Item | Description | Packaging | Cs | In |
|------|-----------------------------|--------------------|----|----|
| 3570 | 6-in-1 Snap Ring Pliers Set | SLIDE BLISTER CARD | 72 | 12 |



5-pc. Snap Ring Pliers Set

- Heat Treated Carbon Steel Construction
- Durable Black Oxide Finish
- Precision-Machined Tips
- Cushioned Non-Slip Handle Grips
- Reversible Jaws Convert Pliers for Use with Both Internal and External Snap Rings
- Size Range: Internal: 3/4" - 1-3/4", External: 3/4" - 2-1/2", Tip Size: .060" and .090"

- 2-pc. 6" Straight Tip (.060")
- 1-pc. 6" 90° Bent Tip (.060")
- 1-pc. 8" Straight Tip (.090")
- 1-pc. 8" 90° Bent Tip (.090")

| Item | Description | Packaging | Cs | In |
|------|----------------------------|-----------|----|----|
| 3580 | 5-pc. Snap Ring Pliers Set | COLOR BOX | 24 | 6 |

66 Pliers and Snips



Locking Pliers

- Drop Forged Hardened Steel Jaws
- Rugged 5-Rivet Construction
- Durable Chrome Plated Finish
- Knurled Thumbscrew Sets Jaw Capacity
- Anvil-Type Wire Cutter

| Item | Description | Packaging | Cs | In |
|------|---------------------------------|----------------------|----|----|
| 3701 | 5" Curved Jaw Locking Pliers | COLOR POLY HANG CARD | 72 | 6 |
| 3706 | 7" Curved Jaw Locking Pliers | COLOR POLY HANG CARD | 60 | 6 |
| 3707 | 7" Straight Jaw Locking Pliers | COLOR POLY HANG CARD | 60 | 6 |
| 3711 | 10" Curved Jaw Locking Pliers | COLOR POLY HANG CARD | 48 | 6 |
| 3712 | 10" Straight Jaw Locking Pliers | COLOR POLY HANG CARD | 60 | 6 |



Long Nose Locking Pliers

- Drop Forged Hardened Steel Jaws
- Rugged 5-Rivet Construction
- Durable Chrome Plated Finish
- Knurled Thumbscrew Sets Jaw Capacity
- Anvil-Type Wire Cutter

| Item | Description | Packaging | Cs | In |
|------|-----------------------------|----------------------|----|----|
| 3719 | 6" Long Nose Locking Pliers | COLOR POLY HANG CARD | 72 | 6 |
| 3721 | 9" Long Nose Locking Pliers | SLIDE BLISTER CARD | 72 | 12 |

2-pc. Locking Plier Set

- Drop Forged Hardened Steel Jaws
- Rugged 5-Rivet Construction
- Durable Chrome Plated Finish
- Knurled Thumbscrew Sets Jaw Capacity
- Anvil-Type Wire Cutter



- 1-pc. 7" Curved Jaw Locking Plier
- 1-pc. 10" Curved Jaw Locking Plier

| Item | Description | Packaging | Cs | In |
|-------|-------------------------|-----------------------|----|----|
| 82591 | 2-pc. Locking Plier Set | SEALED BLISTER - FULL | 24 | 4 |

3-pc. Curved Jaw Locking Pliers Set

- Drop Forged Hardened Steel Jaws
- Rugged 5-Rivet Construction
- Durable Chrome Plated Finish
- Knurled Thumbscrew Sets Jaw Capacity
- Anvil-Type Wire Cutter



- 3-pc. Locking Pliers: 5", 7", 10"
- Complete with Roll-up Storage Pouch

| Item | Description | Packaging | Cs | In |
|------|-------------------------------------|-----------|----|----|
| 3730 | 3-pc. Curved Jaw Locking Pliers Set | COLOR BOX | 20 | 1 |



Aviation Tin Snips

- Forged and Hardened High Carbon Alloy Steel Jaws
- Serrated Cutting Edges
- Compound Hinge Delivers More Force with Less Effort
- Non-Slip Cushioned Handle Grips Reduce Fatigue
- Handle Lock for Safe Storage

| Item | Description | Packaging | Cs | In |
|------|---------------------------------|--------------------|----|----|
| 3636 | Right Cut Aviation Tin Snips | SLIDE BLISTER CARD | 40 | 8 |
| 3641 | Left Cut Aviation Tin Snips | SLIDE BLISTER CARD | 40 | 8 |
| 3646 | Straight Cut Aviation Tin Snips | SLIDE BLISTER CARD | 40 | 8 |



Straight Pattern Tin Snips

- Drop Forged, Heat Treated, High Carbon Steel
- Polished Finish Resists Corrosion
- Rugged, Hardened Cutting Edges
- Comfortable, Non-Slip Cushioned Grips Reduce Fatigue

| Item | Description | Packaging | Cs | In |
|------|--------------------------------|----------------------|----|----|
| 3655 | 8" Straight Pattern Tin Snips | COLOR POLY HANG CARD | 36 | 6 |
| 3660 | 10" Straight Pattern Tin Snips | COLOR POLY HANG CARD | 36 | 6 |
| 3665 | 12" Straight Pattern Tin Snips | COLOR POLY HANG CARD | 24 | 4 |

5-in-1 Combination Tool

- Hardened Steel Construction
- High-Contrast Size Range Markings
- Non-Slip Cushioned Finger Grip Handles
- Cuts and Rethreads Bolt Sizes 4-40, 6-32, 8-32, 10-24, and 10-32
- Strips Solid or Stranded 10-22 AWG wire
- Crimps Wire Terminal Sizes 10-12, 14-16, and 18-22 AWG
- Anvil-Type Wire Cutter
- Ignition Terminal Crimper
- 7-1/2" Length

| Item | Description | Packaging | Cs | In |
|------|-------------------------|--------------------|----|----|
| 3761 | 5-in-1 Combination Tool | SLIDE BLISTER CARD | 72 | 6 |

8-in-1 Electrician's Combination Tool

- Hardened Steel Construction
- High-Contrast Size Range Markings
- Non-Slip Cushioned Handle Grips
- Cuts and Rethreads Bolt Sizes M3, 6-32, M4, 8-32, 10-32
- Strips Solid or Stranded 8-22 AWG wire
- Crimps Insulated Wire Terminal Sizes 10-22 AWG
- Crimps Non-Insulated Wire Terminal Sizes 10-22 AWG
- Anvil-Type Wire Cutter
- Shear-Type Wire and Fastener Cutter
- Ignition Terminal Crimper
- 9-3/4" Length

| Item | Description | Packaging | Cs | In |
|------|---------------------------------------|--------------------|----|----|
| 3775 | 8-in-1 Electrician's Combination Tool | SLIDE BLISTER CARD | 36 | 6 |



3794



3796

Adjustable Wire Stripper

- 3794**
- Hardened Steel Construction
 - Cuts and Strips Wire Sizes 10-24 AWG
 - Set Screw Locks Wire Stripper Capacity
 - Looping Holes Bend Wire for Proper Fit Around Screw Terminals
 - Self-Opening Spring-Loaded Hinge
 - 4" Length

- 3796**
- Hardened Steel Construction
 - Strips Solid and Stranded Wire Sizes 10-18 AWG
 - Crimps Wire Terminal Sizes 14-24 AWG
 - Shear-Type Wire Cutter
 - Looping Holes Bend Wire for Proper Fit Around Screw Terminals
 - Self-Opening Spring-Loaded Hinge
 - Non-Slip Cushioned Handle Grips
 - 6" Length

| Item | Description | Packaging | Cs | In |
|------|--------------------------|--------------------|-----|----|
| 3794 | Adjustable Wire Stripper | SLIDE BLISTER CARD | 120 | 12 |
| 3796 | Wire Stripper/Crimper | SLIDE BLISTER CARD | 120 | 12 |

5-in-1 Combination Tool and 30-pc. Terminal Kit

- Hardened Steel Construction
- High-Contrast Size Range Markings
- Non-Slip Cushioned Finger Grip Handles
- Cuts and Rethreads Bolt Sizes 4-40, 6-32, 8-32, 10-24, and 10-32
- Strips Solid or Stranded 10-22 AWG wire
- Crimps Wire Terminal Sizes 10-12, 14-16, and 18-22 AWG
- Anvil-Type Wire Cutter
- Ignition Terminal Crimper
- 7-1/2" Length

- 1-pc. Combination Tool
- 6-pc. Ring Terminals - Stud 4-6, 22-18 AWG
- 6-pc. Ring Terminals - Stud 4-6, 16-14 AWG
- 4-pc. Ring Terminals - Stud 10, 22-16 AWG
- 4-pc. Ring Terminals - Stud 10, 16-14 AWG
- 5-pc. Block Spade Terminals - Stud 8, 16-14 AWG
- 5-pc. Block Spade Terminals - Stud 10, 22-16 AWG

| Item | Description | Packaging | Cs | In |
|------|---|--------------------|----|----|
| 3765 | 5-in-1 Combination Tool and 30-pc. Terminal Kit | SLIDE BLISTER CARD | 50 | 10 |

84-pc. Insulated Terminal Set

- Heavy Insulating Sleeve Protects Wire Connection
- Solderless Crimp Connection
- NEMA Color Coded
- UL Listed

- 5-pc. Ring Terminals - Stud 4-6, 18-22 AWG
- 5-pc. Ring Terminals - Stud 10, 18-22 AWG
- 5-pc. Ring Terminals - Stud 4-6, 14-16 AWG
- 5-pc. Ring Terminals - Stud 8, 14-16 AWG
- 5-pc. Ring Terminals - Stud 10, 14-16 AWG
- 4-pc. Ring Terminals - Stud 8-10, 10-12 AWG
- 4-pc. Ring Terminals - Stud 1/4", 10-12
- 4-pc. Butt Connectors - 18-22 AWG
- 5-pc. Butt Connectors - 14-16 AWG
- 4-pc. Butt Connectors - 10-12 AWG
- 4-pc. Block Spade Terminals - Stud 8-10, 18-22 AWG
- 5-pc. Block Spade Terminals - Stud 10, 18-22 AWG
- 5-pc. Block Spade Terminals - Stud 8, 14-16 AWG
- 5-pc. Block Spade Terminals - Stud 10, 14-16 AWG
- 4-pc. 1/4" Push-on Tab (M) Terminals - 18-22 AWG
- 5-pc. 1/4" Push-on Tab (F) Terminals - 18-22 AWG
- 5-pc. 1/4" Push-on Tab (M) Terminals - 14-18 AWG
- 5-pc. 1/4" Push-on Tab (F) Terminals - 14-18 AWG

| Item | Description | Packaging | Cs | In |
|------|-------------------------------|--------------------|----|----|
| 3782 | 84-pc. Insulated Terminal Set | SLIDE BLISTER CARD | 72 | 12 |

Automatic Wire Stripper/Cutter

- Strips and Cuts Solid or Stranded Wire Sizes 10-32 AWG
- Automatically Adjusts to Wire Size and Strips Insulation in One Motion
- Can Strip Multiple Wires at the Same Time
- Inch/Metric Jaw Markings Measure Strip Length
- Shear-Type Wire Cutter
- Comfortable Contoured Handles

| Item | Description | Packaging | Cs | In |
|------|--------------------------------|--------------------|----|----|
| 3792 | Automatic Wire Stripper/Cutter | SLIDE BLISTER CARD | 60 | 6 |





Rosin Core Solder

- 7262**
- General Purpose Lead-Free Rosin Core Solder
 - Solder Composition: 100% Sn
 - Melting Range: 227-229°C
 - Convenient Dispensing Storage Container
 - Net Weight: 5 oz.

- 7263**
- General Purpose Lead-Free Rosin Core Solder
 - Solder Composition: 96% Sn / 4% Ag
 - Melting Range: 217-220° C
 - Convenient Dispensing Storage Container
 - Net Weight: 5 oz.

| Item | Description | Packaging | Cs | In |
|------|-------------------|--------------------|----|----|
| 7262 | Rosin Core Solder | SLIDE BLISTER CARD | 72 | 2 |
| 7263 | Rosin Core Solder | SLIDE BLISTER CARD | 72 | 2 |



100-Watt Soldering Gun

- Insulated Polymer Body with Comfortable Pistol-Grip Handle
- Trigger Action Instantly Heats Tip
- Built-in Worklight Provides Focused Illumination
- Replaceable Nickel Plated Tips
- UL Listed
- General-Purpose Soldering Gun for Electronics Repair, Wiring Connections, and Automotive Electrical System Repairs

- Specifications:
- Max. Tip Temperature: 700°
 - Power Usage: 110-120V, 100W
 - Cord Length: 5'

- 1-pc. Soldering Gun
- 1-pc. Chisel Tip
- 1-pc. Soldering Tip
- 1-pc. Tip Wrench
- 1-pc. Solder Dispenser
- 1-pc. Flux

| Item | Description | Packaging | Cs | In |
|------|------------------------|-----------------------|----|----|
| 7278 | 100-Watt Soldering Gun | SEALED BLISTER - FULL | 24 | 4 |



30-Watt Soldering Iron

- Insulated Pencil-Type Polymer Handle
- Replaceable Nickel Plated Tip
- UL Listed
- Complete with Tip Stand
- General-Purpose Soldering Iron for Electronics Repair, Wiring Connections, Automotive Electrical System Repairs, and Circuit Boards

- Specifications:
- Max. Tip Temperature: 700°
 - Power Usage: 110-120V, 30W
 - Cord Length: 5-1/2'

| Item | Description | Packaging | Cs | In |
|------|------------------------|--------------------|-----|----|
| 7266 | 30-Watt Soldering Iron | SLIDE BLISTER CARD | 100 | 5 |



3/4" x 60' Electrical Tape

- Stretchy Vinyl Tape Conforms to Irregular Contours
- General Purpose
- UL Listed
- Suitable for use up to 600V and 80°C (176°F)
- Black, 3/4" x 60' x 7mil

| Item | Description | Packaging | Cs | In |
|------|----------------------------|------------------|-----|----|
| 7375 | 3/4" x 60' Electrical Tape | BULK/COLOR LABEL | 240 | 10 |



5-pc. Color Vinyl Tape

- Standard-Grade Vinyl Tape with Medium Adhesion
- Ideal for Marking and Color Coding Applications
- Roll Length: 12'
- Roll Width: 3/4"
- Thickness: 7 mil

| Item | Description | Packaging | Cs | In |
|------|------------------------|--------------------|-----|----|
| 7385 | 5-pc. Color Vinyl Tape | SLIDE BLISTER CARD | 100 | 10 |



16-Range Electric Multi-Tester

- Super Sensitive Meter is Diode Protected
- Easy-to-Read Color Coded Scale
- Pocket Sized for Easy Storage
- Hundreds of Uses for Home, Auto, Small Engines, Projects, Hobbies, etc.
- Power Source: One "AA" Battery (Included)

Test Ranges:

- AC-V: 0-10V-50V-250V-500V
- DC-V: 0-2.5V-10V-50V-250V-500V
- DC-A: 0-500 μ A-10mA-250mA
- Resistance: 0-10 Ohm-1 kOhm (1Megohm Max.)
- Battery: 1.5-9V

- 1-pc. Multi-Tester
- 2-pc. Test Leads (Red and Black)
- 1-pc. "AA" Battery

| Item | Description | Packaging | Cs | In |
|------|--------------------------------|--------------------|----|----|
| 5898 | 16-Range Electric Multi-Tester | SLIDE BLISTER CARD | 40 | 5 |



Digital Multi-Tester

- Diode and Fuse Protected
- Easy-Read Digital LCD Display
- 7 Functions and 19 Ranges: Measures AC/DC Voltage, DC Current, Resistance and Tests Transistors, Diodes, Continuity and Batteries
- Power Source: One 9-Volt Battery (Included)

Test Ranges:

- AC-V: 0-200-750V
- DC-V: 0-200mV-2000mV-20V-200V-1000V
- DC-A: 0-200 μ A-2000 μ A-20mA-200mA-10A
- Resistance: 0-200 Ohm-2000 Ohm-20 kOhm-200 kOhm-2000 kOhm
- Battery: 1.5-9V

- 1-pc. Multi-Tester
- 2-pc. Test Leads (Red and Black)
- 1-pc. 9-Volt Battery

| Item | Description | Packaging | Cs | In |
|------|----------------------|--------------------|----|----|
| 5899 | Digital Multi-Tester | SLIDE BLISTER CARD | 48 | 6 |



Battery, Bulb and Fuse Tester

Tests:

- Voltage of AAA, AA, C, D, 9-Volt and Button Cell Batteries
- Continuity of Standard Appliance, Household, Automotive and Decorative Light Bulbs
- Continuity of Glass-Type and Blade-Type Fuses
- Tests General Purpose, Alkaline and Rechargeable Batteries
- Accurately Checks Battery Capacity Under Simulated Load Conditions
- Reduce Waste and Save Unnecessary Expense - Check Batteries, Bulbs, and Fuses before Replacing
- Troubleshoot Electronic Devices by Verifying Battery Output
- Easy-Read Analog Meter
- Requires 9-Volt Battery (not Included)

| Item | Description | Packaging | Cs | In |
|------|-------------------------------|--------------------|----|----|
| 7333 | Battery, Bulb and Fuse Tester | SLIDE BLISTER CARD | 24 | 6 |



110-460 V Voltage Tester

- Tests AC and DC Circuits
- Four Voltage Ranges: 110V, 220V, 277V, 460V
- Tests Voltage, Polarity, and Grounding
- Lamps Glow when Voltage is Present
- Insulated Housing with Pocket Clip

| Item | Description | Packaging | Cs | In |
|------|--------------------------|--------------------|-----|----|
| 7337 | 110-460 V Voltage Tester | SLIDE BLISTER CARD | 100 | 10 |



3-Wire Receptacle Tester

- Detects Faulty Wiring Conditions in 3-Prong 110-125V AC Receptacles
- Color-Coded Indicator Lights
- Simple to Use - Plugs into Outlet Like any Electrical Cord
- Indicates Open Ground, Open Neutral, Open Hot, Hot/Ground Reverse, Hot/Neutral Reverse, and Correct Wiring Conditions
- UL-Listed

| Item | Description | Packaging | Cs | In |
|------|--------------------------|--------------------|-----|----|
| 7338 | 3-Wire Receptacle Tester | SLIDE BLISTER CARD | 144 | 12 |



4-pc. Tweezer Set

- Stainless Steel Construction
- Non-Slip Knurled Grips
- Use for Electronics Repair, Precision Assembly, and Models
- 4-1/2" Overall Length
- 1-pc. Straight Fine Tip
- 1-pc. Bent Broad Tip
- 1-pc. 45° Angle Fine Tip
- 1-pc. Reverse Action Fine Tip

| Item | Description | Packaging | Cs | In |
|------|-------------------|--------------------|----|----|
| 7490 | 4-pc. Tweezer Set | SLIDE BLISTER CARD | 96 | 6 |



500-pc. Cable Ties

- Strong Nylon Construction
- Self-Locking Teeth will not Loosen
- Use Assorted Colors to Organize Groups of Wires, Cables or Hoses
- 500-pc. 4" (3/32") Cable Ties:
 - 100-pc. Orange
 - 100-pc. Green
 - 100-pc. Yellow
 - 100-pc. Black
 - 100-pc. White
- Complete with Storage Canister

| Item | Description | Packaging | Cs | In |
|------|--------------------|-------------------|----|----|
| 6233 | 500-pc. Cable Ties | CAN/TUBE W/ LABEL | 48 | 6 |



200-pc. Assorted Cable Ties

- Strong Nylon Construction
- Self-Locking Teeth will not Loosen
- Use Assorted Colors to Organize Groups of Wires, Cables or Hoses

| Item | Description | Packaging | Cs | In |
|------|-----------------------------|-------------------|----|----|
| 6235 | 200-pc. Assorted Cable Ties | CAN/TUBE W/ LABEL | 72 | 6 |



Helping Hand with Magnifier

- Heavy Duty Cast Iron Base
- 2-1/2", 2X Magnifying Glass for Precision Work without Eyestrain
- Dual Alligator Spring Clamps Hold Workpiece Steady
- Mirror and Clamps are Mounted on Adjustable Ball Joints to Position and View Work at any Angle
- Frees Hands for Soldering, Gluing, Positioning, Fastening, and Assembly

| Item | Description | Packaging | Cs | In |
|------|-----------------------------|-----------------------|----|----|
| 7521 | Helping Hand with Magnifier | SEALED BLISTER - FULL | 12 | 6 |



50-pc. Assorted Cable Ties

- Strong Nylon Construction
- Self-Locking Teeth will not Loosen
- 20-pc. 4" (3/32") Cable Ties
- 20-pc. 6" (3/32") Cable Ties
- 10-pc. 8" (3/16") Cable Ties

| Item | Description | Packaging | Cs | In |
|------|----------------------------|-------------------------|-----|----|
| 6234 | 50-pc. Assorted Cable Ties | POLYBAG/COLOR HANG CARD | 144 | 12 |

- 125-pc. 4" (3/32") Cable Ties:
 - 25-pc. Orange
 - 25-pc. Green
 - 25-pc. Yellow
 - 25-pc. Black
 - 25-pc. White
- 50-pc. 8" (1/8") Cable Ties:
 - 18-pc. Orange
 - 16-pc. Black
 - 16-pc. White
- 25-pc. 12" (3/16") Cable Ties: Black
- Complete with Storage Canister

NEW



Locking "C" Clamps

- Drop Forged Carbon Steel Jaws
- Corrosion-Resistant Chrome Plated Finish
- Knurled Thumbscrew Sets Jaw Capacity
- One-Touch Quick Release

| Item # | Jaw Capacity |
|--------|--------------|
| 3815 | 1-1/2" |
| 3825 | 3" |
| 3835 | 7" |

| Item | Description | Packaging | Cs | In |
|------|-----------------------|-----------|----|----|
| 3815 | 6" Locking "C" Clamp | HANG CARD | 72 | 6 |
| 3825 | 11" Locking "C" Clamp | HANG CARD | 30 | 6 |
| 3835 | 18" Locking "C" Clamp | HANG CARD | 24 | 6 |



Welding and Sheet Metal Clamps

- 3850**
- Drop Forged Carbon Steel Jaws
 - Corrosion-Resistant Chrome Plated Finish
 - Knurled Thumbscrew Sets Jaw Capacity
 - One-Touch Quick Release
 - Deep Jaws Hold Angle and Bar Stock

- 3855**
- Drop Forged Carbon Steel Jaws
 - Corrosion-Resistant Chrome Plated Finish
 - Knurled Thumbscrew Sets Jaw Capacity
 - One-Touch Quick Release
 - Flat Jaws Hold and Crimp Sheet Metal

| Item | Description | Packaging | Cs | In |
|------|----------------------|--------------------|----|----|
| 3850 | 9" Welding Clamp | SLIDE BLISTER CARD | 30 | 6 |
| 3855 | 8" Sheet Metal Clamp | SLIDE BLISTER CARD | 30 | 6 |

Locking Chain Clamp

- Creates a Non-Slip, Locking Grip on Round or Irregular Shapes
- Hardened Carbon Steel Handles
- Corrosion-Resistant Chrome Plated Finish
- Knurled Thumbscrew Sets Jaw Capacity
- One-Touch Quick Release

- Specifications:
- 5-1/2" Diameter Maximum Capacity
 - 9" Handle Length

| Item | Description | Packaging | Cs | In |
|------|---------------------|--------------------|----|----|
| 3960 | Locking Chain Clamp | SLIDE BLISTER CARD | 30 | 6 |



Locking "C" Clamps with Swivel Jaw Pad

- Drop Forged Hardened Steel Jaws
- Durable Chrome Plated Finish
- Self-Leveling Swivel Jaw Pads
- Knurled Thumbscrew Sets Jaw Capacity
- One Touch Quick Release

| Item # | Jaw Capacity |
|--------|--------------|
| 3816 | 1-3/4" |
| 3826 | 2-1/2" |
| 3836 | 7" |

| Item | Description | Packaging | Cs | In |
|------|----------------------------------|----------------------|----|----|
| 3816 | 6" Swivel Pad Locking "C" Clamp | COLOR POLY HANG CARD | 72 | 6 |
| 3826 | 11" Swivel Pad Locking "C" Clamp | COLOR POLY HANG CARD | 30 | 6 |
| 3836 | 18" Swivel Pad Locking "C" Clamp | COLOR POLY HANG CARD | 24 | 6 |



3-pc. Welding Clamp Set

- Drop Forged, Heat Treated Steel Jaws
- Chrome Plated for Durability
- Powerful Non-Slip Jaws Lock and Unlock with a Simple Squeeze
- Thumb Screw Adjusts Lock Jaw Capacity
- Use as Vice Clamps for Simple or Awkward Welding, Soldering, and Riveting Jobs

- 1-pc. 11" Locking C-Clamp
- 1-pc. 8" Sheet Metal Clamp
- 1-pc. 9" Welding Clamp
- Complete w/PVC Roll-up Carrying Pouch

| Item | Description | Packaging | Cs | In |
|------|-------------------------|-----------|----|----|
| 3861 | 3-pc. Welding Clamp Set | COLOR BOX | 10 | 1 |





4-pc. 4" Steel Spring Clamps

- Nickel Plated Steel Construction
- Cushioned Non-Slip Handle Grips
- Non-Slip Padded Jaws Grip Workpiece without Damaging Surface
- Tempered Steel Spring for Consistent Holding Power

| Item | Description | Packaging | Cs | In |
|------|------------------------------|-------------------|----|----|
| 3896 | 4-pc. 4" Steel Spring Clamps | POLYBAG/HANG CARD | 72 | 12 |



2" Mini Steel Spring Clamps

- Chrome Plated Steel Construction
- Strong Gripping, Spring-Action Jaws
- Tempered Steel Springs
- Comfortable PVC Dipped Handles
- Non-Slip PVC Dipped Tips Grip Work Piece and Will Not Damage Surface
- 3/4" Open Jaw Capacity
- Ideal for Precise Gluing Jobs and Hobby Applications

3902

- MINIMUM ORDER QUANTITY: 10-PC. POLYBAG

| Item | Description | Packaging | Cs | In |
|------|------------------------------------|--------------------|------|----|
| 3902 | 10-pc. 2" Mini Steel Spring Clamps | POLYBAG/NO UPC | 1000 | 10 |
| 3904 | 4-pc. 2" Mini Steel Spring Clamps | SLIDE BLISTER CARD | 144 | 12 |



Steel Spring Clamps

- Chrome Plated Steel Construction
- Cushioned Non-Slip Handle Grips
- Non-Slip Padded Jaws Grip Workpiece without Damaging Surface
- Tempered Steel Spring for Consistent Holding Power

Item # Jaw Capacity

3906 1-1/4"

3911 2"

3916 3-1/2"

| Item | Description | Packaging | Cs | In |
|------|-----------------------|-----------|-----|----|
| 3906 | 4" Steel Spring Clamp | TIE CARD | 200 | 10 |
| 3911 | 6" Steel Spring Clamp | TIE CARD | 120 | 10 |
| 3916 | 9" Steel Spring Clamp | TIE CARD | 60 | 12 |

Supergrip Spring Clamps

- Extra Strong Nylon and Fiberglass Construction
- Non-Slip Textured Handle Grips
- Wide Jaw Pads Pivot to Fit Workpiece for a Uniform Grip on Uneven Surfaces
- Tempered Steel Spring for Consistent Holding Power

| Item | Description | Packaging | Cs | In |
|------|---------------------------|-----------|-----|----|
| 3903 | 3" Supergrip Spring Clamp | TIE CARD | 288 | 24 |
| 3907 | 4" Supergrip Spring Clamp | TIE CARD | 200 | 10 |
| 3912 | 6" Supergrip Spring Clamp | TIE CARD | 100 | 10 |
| 3917 | 9" Supergrip Spring Clamp | TIE CARD | 40 | 10 |

| Item # | Jaw Capacity |
|--------|--------------|
| 3903 | 1-1/4" |
| 3907 | 1-1/4" |
| 3912 | 2-1/2" |
| 3917 | 3-1/2" |



Supergrip Spring Clamps

- Extra Strong Nylon and Fiberglass Construction
- Comfortable Cushioned Non-Slip Handle Grips
- Wide Jaw Pads Pivot to Fit Workpiece for a Uniform Grip on Uneven Surfaces
- Tempered Steel Springs for Consistent Holding Power

| Item | Description | Packaging | Cs | In |
|------|---------------------------|-----------|-----|----|
| 3913 | 3" Supergrip Spring Clamp | TIE CARD | 288 | 24 |
| 3914 | 4" Supergrip Spring Clamp | TIE CARD | 200 | 10 |
| 3915 | 6" Supergrip Spring Clamp | TIE CARD | 100 | 10 |
| 3919 | 9" Supergrip Spring Clamp | TIE CARD | 40 | 10 |

| Item # | Jaw Capacity |
|--------|--------------|
| 3913 | 1-1/4" |
| 3914 | 1-3/4" |
| 3915 | 2-1/8" |
| 3919 | 3-3/8" |



4-pc. Spring Clip Magnets

- Durable and Attractive Chrome Plated Finish
- Strong Grip Spring Clips
- Mount to Refrigerators, Work Stations, Metal Doors and Cabinets

| Item | Description | Packaging | Cs | In |
|------|---------------------------|--------------------|----|----|
| 3890 | 4-pc. Spring Clip Magnets | SLIDE BLISTER CARD | 96 | 12 |





Ratchet Bar Clamps

- Super-Strong Nylon Jaw Assemblies
- Trigger Action Applies Precise Clamping Force
- Smooth, Silent, and Precise Ratcheting Action
- Position Jaw Instantly Along Bar with Quick Release Button
- Soft Jaw Pads will not Scratch or Mar Surfaces
- Bar Clamp Jaws Convert for Use as Spreaders

| Item # | Jaw Capacity | Throat Depth |
|--------|--------------|--------------|
| 39180 | 6" | 1.5" |
| 39181 | 6" | 2.5" |
| 39182 | 12" | 2.5" |
| 39183 | 18" | 2.5" |
| 39184 | 24" | 2.5" |
| 39185 | 30" | 2.5" |
| 39186 | 36" | 2.5" |

| Item | Description | Packaging | Cs | In |
|-------|------------------------------|-----------|-----|----|
| 39180 | 6" x 1.5" Ratchet Bar Clamp | TIE CARD | 144 | 6 |
| 39181 | 6" x 2.5" Ratchet Bar Clamp | WRAP CARD | 48 | 4 |
| 39182 | 12" x 2.5" Ratchet Bar Clamp | WRAP CARD | 36 | 4 |
| 39183 | 18" x 2.5" Ratchet Bar Clamp | WRAP CARD | 24 | 4 |
| 39184 | 24" x 2.5" Ratchet Bar Clamp | WRAP CARD | 24 | 3 |
| 39185 | 30" x 2.5" Ratchet Bar Clamp | WRAP CARD | 12 | 2 |
| 39186 | 36" x 2.5" Ratchet Bar Clamp | WRAP CARD | 12 | 2 |



Slide Locking Bar Clamps

- Malleable Steel Jaws, Heat Treated Steel Bar
- Chrome Plated Steel Screw with Swivel Pad
- Hardwood Screw Handle
- Precision Notched Steel Bar Holds Objects Safely At the Correct Tension for Gluing, Fastening, and Securing
- Quick-Slide Lock Allows Jaw to Move to Any Position with the Touch of a Button

| Item # | Jaw Capacity | Throat Depth |
|--------|--------------|--------------|
| 3926 | 12" | 2-1/2" |
| 3927 | 14-1/2" | 2-1/2" |
| 3928 | 20-1/2" | 2-1/2" |
| 3929 | 32" | 2-1/2" |

| Item | Description | Packaging | Cs | In |
|------|------------------------------------|-----------|----|----|
| 3926 | 12" x 2.5" Slide Locking Bar Clamp | BULK/UPC | 30 | 5 |
| 3927 | 18" x 2.5" Slide Locking Bar Clamp | BULK/UPC | 25 | 5 |
| 3928 | 24" x 2.5" Slide Locking Bar Clamp | BULK/UPC | 24 | 4 |
| 3929 | 36" x 2.5" Slide Locking Bar Clamp | BULK/UPC | 20 | 4 |

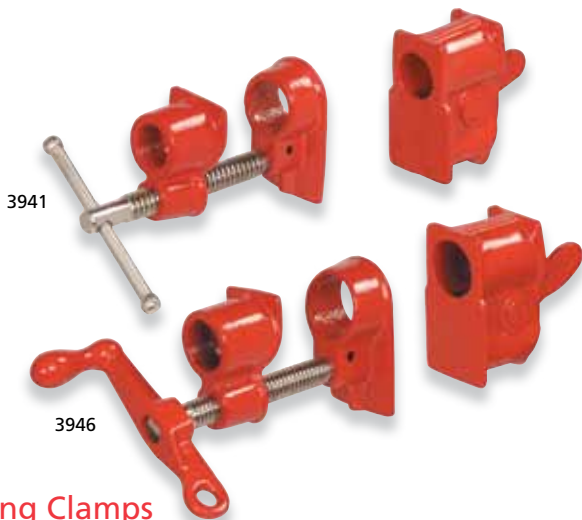

Gluing Clamps

- Strong, Malleable Steel Construction
- Use with a 3/4" or 1/2" Pipe to Make a Clamping Fixture of any Length Desired
- Spring Lever Allows Jaw to Quickly Slide to Any Location and Lock in Place

| Item | Description | Packaging | Cs | In |
|------|-------------------|-----------------------|----|----|
| 3941 | 1/2" Gluing Clamp | SEALED BLISTER - FULL | 12 | 4 |
| 3946 | 3/4" Gluing Clamp | SEALED BLISTER - FULL | 12 | 4 |

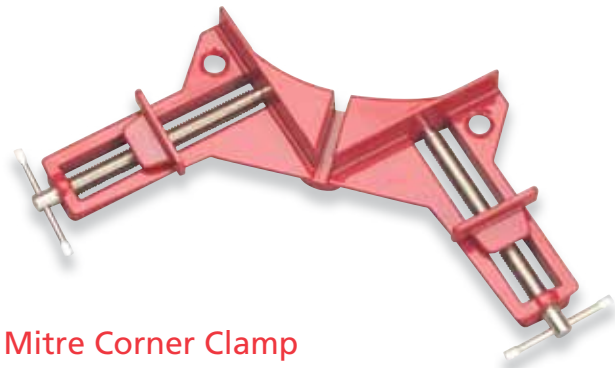

90° Mitre Corner Clamp

- Aluminum Alloy Construction
- Precision-Machined Steel Screw Assemblies with Sliding T-Bar Handles
- Holds Work Pieces at a 90-Degree Angle for Assembling Mitre or Butt Joints
- Holds Two Pieces of Different Widths at one Time
- Two Counter-Sunk Holes for Mounting Clamp to Work Bench

- Capacities:
- Jaw Capacity: 2-7/8"
 - Throat Depth: 1/2"

| Item | Description | Packaging | Cs | In |
|------|------------------------|--------------------|----|----|
| 3955 | 90° Mitre Corner Clamp | SLIDE BLISTER CARD | 60 | 6 |



3-pc. Mini "C" Clamp Set

- Malleable Steel Frame
- Nickel Plated Steel Screw with Swivel Pad
- Sliding T-Bar Handle
- Durable Baked Enamel Finish
- 2-pc. 1" C-Clamp (3/4" Throat Depth)
- 1-pc. 2-1/2" C-Clamp (1-1/4" Throat Depth)

| Item | Description | Packaging | Cs | In |
|------|--------------------------|--------------------|----|----|
| 3982 | 3-pc. Mini "C" Clamp Set | SLIDE BLISTER CARD | 72 | 6 |

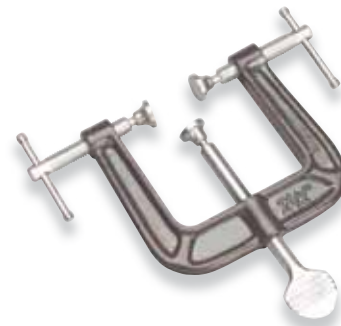

2-1/2" 3-Way Heavy Duty "C" Clamp

- Heavy-Duty Malleable Steel Frame
- Chrome Plated Steel Screws with Swivel Pads
- Sliding T-Bar and Oversized Thumbscrew Handles
- Durable Baked Enamel Finish

| Item | Description | Packaging | Cs | In |
|------|-----------------------------------|-----------|----|----|
| 4005 | 2-1/2" 3-Way Heavy Duty "C" Clamp | HANG CARD | 48 | 4 |

2-1/2" Heavy Duty Deep Throat "C" Clamp

- Heavy-Duty Malleable Steel Frame
- Chrome Plated Steel Screw with Swivel Pad
- Sliding T-Bar Handle
- Durable Baked Enamel Finish
- 2-1/2" Throat Depth

| Item | Description | Packaging | Cs | In |
|------|---|-----------|----|----|
| 4008 | 2-1/2" Heavy Duty Deep Throat "C" Clamp | HANG CARD | 48 | 6 |



Heavy Duty "C" Clamps

- Heavy-Duty Malleable Steel Frame
- Chrome Plated Steel Screw with Swivel Pad
- Sliding T-Bar Handle
- Durable Baked Enamel Finish

| Item | Description | Packaging | Cs | In |
|------|--------------------------|-----------|----|----|
| 4009 | 1" Heavy Duty "C" Clamp | HANG CARD | 72 | 12 |
| 4011 | 2" Heavy Duty "C" Clamp | HANG CARD | 72 | 12 |
| 4012 | 3" Heavy Duty "C" Clamp | HANG CARD | 48 | 6 |
| 4017 | 4" Heavy Duty "C" Clamp | TIE CARD | 36 | 6 |
| 4022 | 5" Heavy Duty "C" Clamp | TIE CARD | 24 | 4 |
| 4027 | 6" Heavy Duty "C" Clamp | TIE CARD | 12 | 4 |
| 4031 | 8" Heavy Duty "C" Clamp | TIE CARD | 12 | 3 |
| 4035 | 10" Heavy Duty "C" Clamp | TIE CARD | 6 | 1 |
| 4040 | 12" Heavy Duty "C" Clamp | TIE CARD | 6 | 1 |

| Item # | Jaw Opening | Throat Depth |
|--------|-------------|--------------|
| 4009 | 1" | 1" |
| 4011 | 2" | 1-1/8" |
| 4012 | 3" | 1-1/2" |
| 4017 | 4" | 2-1/4" |
| 4022 | 5" | 2-3/8" |
| 4027 | 6" | 2-3/4" |
| 4031 | 8" | 3-3/8" |
| 4035 | 10" | 4-3/4" |
| 4040 | 12" | 5-1/8" |



Drill Press Vises

- Solid Cast Construction
- Replaceable Non-Slip Serrated Steel Jaws
- Chrome Plated, Cold Rolled Steel Screw
- 180° Pivoting Crank Handle
- Four-Slot Base for Precise Mounting Position

| Item # | Jaw Width | Jaw Opening |
|--------|-----------|-------------|
| 5301 | 3" | 3" |
| 5306 | 4" | 3-3/4" |
| 5310 | 5" | 4-1/2" |
| 5315 | 6" | 5-3/4" |

| Item | Description | Packaging | Cs | In |
|------|---------------------|-----------|----|----|
| 5301 | 3" Drill Press Vise | COLOR BOX | 10 | 1 |
| 5306 | 4" Drill Press Vise | COLOR BOX | 8 | 1 |
| 5310 | 5" Drill Press Vise | COLOR BOX | 4 | 1 |
| 5315 | 6" Drill Press Vise | COLOR BOX | 3 | 1 |

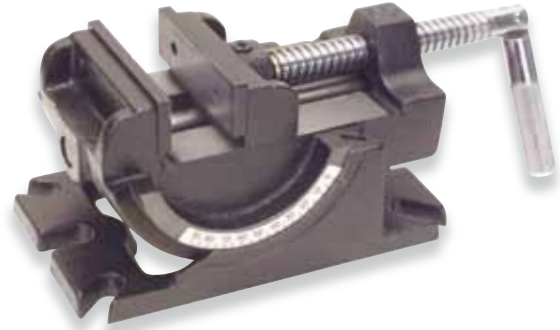

3" Universal Angle Vise

- Solid Cast Construction
- Replaceable Steel Jaws
- Chrome Plated, Cold Rolled Steel Screw
- 180° Pivoting Crank Handle with Knurled Grip
- Set Angle Positions from 0° (Horizontal) to 90° (Vertical)
- Six-Slot Base Mounts Securely to Work Surface

| Jaw Width | Jaw Opening | Throat Depth |
|-----------|-------------|--------------|
| 3" | 3-1/2" | 1-1/4" |

| Item | Description | Packaging | Cs | In |
|------|-------------------------|-----------|----|----|
| 5325 | 3" Universal Angle Vise | COLOR BOX | 6 | 1 |

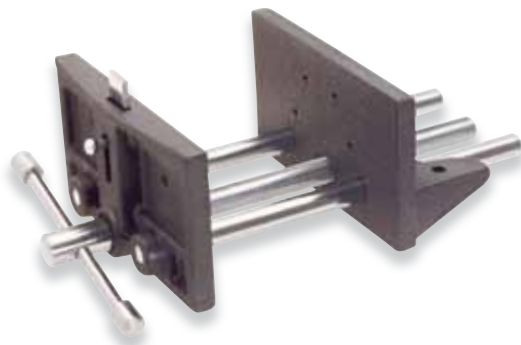

6-1/2" Wood Working Vise

- Solid Cast Jaw Construction
- Pre-Drilled to Accept Wood Jaw Pads
- Chrome Plated, Cold Rolled Steel Screw with Sliding T-Bar Handle
- Chrome Plated Steel Guide Rails
- Four-Slot Base Mounts Under Work Table Surface

| Jaw Width | Jaw Opening | Throat Depth |
|-----------|-------------|--------------|
| 6-1/2" | 7-1/2" | 2-1/2" |

| Item | Description | Packaging | Cs | In |
|------|--------------------------|-----------|----|----|
| 5371 | 6-1/2" Wood Working Vise | COLOR BOX | 6 | 1 |

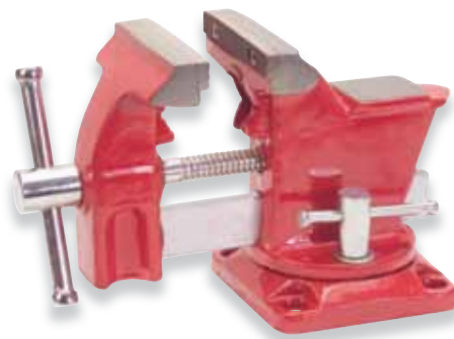

3-1/2" Home Vise

- Solid Cast Construction
- 360° Swivel Base with Dual Lock Down Nuts
- Replaceable Non-Slip Steel Jaw Pads
- Serrated Pipe Jaws
- Chrome Plated Sliding T-Bar Handle
- Four-Slot Mounting Base

| Jaw Width | Jaw Opening | Throat Depth | Anvil Size | Pipe Jaw Capacity |
|-----------|-------------|--------------|------------|-------------------|
| 3-1/2" | 2-1/2" | 2-1/2" | 1-1/2" | 1" |

| Item | Description | Packaging | Cs | In |
|------|------------------|-----------|----|----|
| 5380 | 3-1/2" Home Vise | COLOR BOX | 6 | 1 |

Swivel Bench Vises

5384 - 5400

- Solid Cast Construction
- 360° Swivel Base with Dual Lock Down Nuts
- Replaceable Non-Slip Steel Jaw Pads
- Chrome Plated Sliding T-Bar Handle
- Three-Slot Mounting Base

5409

- Malleable Steel Construction
- 360° Swivel Base with Dual Lock Down Nuts
- Replaceable Non-Slip Steel Jaw Pads
- Serrated Pipe Jaws
- Chrome Plated Sliding T-Bar Handle
- Three-Slot Mounting Base

| Item # | Jaw Width | Jaw Opening | Throat Depth | Anvil Size | Pipe Jaw Capacity |
|--------|-----------|-------------|--------------|------------|-------------------|
| 5384 | 3" | 4" | 2" | 2-3/4" | - |
| 5385 | 4" | 4-1/2" | 2-1/4" | 3-1/2" | 1/2" |
| 5395 | 5" | 5" | 2-1/2" | 4-1/2" | 1" |
| 5400 | 6" | 6" | 3" | 5-1/2" | 1" |
| 5409 | 8" | 7-1/4" | 3-1/2" | 3-3/4" | 1-1/2" |

| Item | Description | Packaging | Cs | In |
|------|----------------------|-----------|----|----|
| 5384 | 3" Swivel Bench Vise | COLOR BOX | 4 | 1 |
| 5385 | 4" Swivel Bench Vise | COLOR BOX | 2 | 1 |
| 5395 | 5" Swivel Bench Vise | COLOR BOX | 1 | 1 |
| 5400 | 6" Swivel Bench Vise | COLOR BOX | 1 | 1 |
| 5409 | 8" Swivel Bench Vise | COLOR BOX | 1 | 1 |



5384 - 5400



5409

5" Multi-Purpose Vise

- Solid Cast Construction
- 360° Swivel Base with Dual Lock Down Nuts
- 360° Rotating Head
- Replaceable Non-Slip Steel Jaw Pads
- Serrated Pipe Jaws
- Chrome Plated Sliding T-Bar Handle
- Three-Slot Mounting Base

| Jaw Width | Jaw Opening | Throat Depth | Anvil Size | Pipe Jaw Capacity |
|-----------|-------------|--------------|------------|-------------------|
| 5" | 4-1/2" | 3" | 3 x 3-3/4" | 1-1/2" |

| Item | Description | Packaging | Cs | In |
|------|-----------------------|-----------|----|----|
| 5405 | 5" Multi-Purpose Vise | COLOR BOX | 1 | 1 |



Arrow Magnetic Welding Holders

- Powerful Magnet Riveted into Durable Steel Housing
- Holds Work at 45°, 90°, and 135° Angles
- Use for Hands-Free Positioning of Ferrous Metal Parts for Welding, Soldering, and Assembly

| Item # | Max. Holding Cap. | Max. Lift Capacity |
|--------|-------------------|--------------------|
| 5217 | 50 LBS | 35 LBS |
| 5218 | 25 LBS | 15 LBS |
| 5219 | 75 LBS | 50 LBS |

| Item | Description | Packaging | Cs | In |
|------|--------------------------------|--------------------|----|----|
| 5217 | 50-lb. Magnetic Welding Holder | SLIDE BLISTER CARD | 36 | 6 |
| 5218 | 25-lb. Magnetic Welding Holder | SLIDE BLISTER CARD | 60 | 6 |
| 5219 | 75-lb. Magnetic Welding Holder | SLIDE BLISTER CARD | 24 | 6 |





Mini Tubing Cutter

- Rugged Cast Zinc Body
- Hardened Alloy Steel Cutting Wheel
- Large Knurled Knob for Precise Adjustment of Cutting Pressure
- Grooved Guide Rollers Ensure Square Cuts Even Close to Flared Ends
- Compact Size for Use in Tight Work Areas
- Cuts Copper, Brass, Aluminum, Mild Steel (Thin-Wall) and Plastic
- Pipe Capacity: 1/8" to 5/8" O.D.

| Item | Description | Packaging | Cs | In |
|------|--------------------|--------------|-----|----|
| 6455 | Mini Tubing Cutter | BLISTER CARD | 240 | 12 |



Tubing Cutter

- Rugged Cast Aluminum Frame
- Hardened Alloy Steel Cutting Wheel
- Large Knurled Knob for Precise Adjustment of Cutting Pressure
- Grooved Guide Rollers Ensure Square Cuts Even Close to Flared Ends
- Retractable Reamer Blade
- Cuts Copper, Brass, Aluminum, Mild Steel (Thin-Wall) and Plastic
- Pipe Capacity: 1/8" to 1-1/8" O.D.

| Item | Description | Packaging | Cs | In |
|------|---------------|--------------------|----|----|
| 6460 | Tubing Cutter | SLIDE BLISTER CARD | 60 | 6 |



Quick Adjust Tubing Cutter

- Rugged Cast Aluminum Frame
- Hardened Alloy Steel Cutting Wheel
- Quick-Release Sliding Screw Feed Arm Instantly Adjusts to Tube Size
- Large Knurled Knob for Precise Adjustment of Cutting Pressure
- Grooved Guide Rollers Ensure Square Cuts Even Close to Flared Ends
- Retractable Reamer Blade
- Cuts Copper, Brass, Aluminum, Mild Steel (Thin-Wall) and Plastic
- Pipe Capacity: 1/8" to 1-1/4" O.D.

| Item | Description | Packaging | Cs | In |
|------|----------------------------|--------------------|----|----|
| 6461 | Quick Adjust Tubing Cutter | SLIDE BLISTER CARD | 60 | 6 |



Pipe Cutter

- Heavy Duty Malleable Steel Frame
- Hardened Alloy Steel Cutting Wheel
- Extra Large T-Handle Screw Feed for Precise Adjustment of Cutting Pressure
- Parallel Guide Rollers Ensure a Square Cut
- Cuts Copper and Thin-Walled Steel Pipe, Metal Conduit, Brass and Aluminum Tubing
- Pipe Capacity: 1/2" to 2" O. D.

| Item | Description | Packaging | Cs | In |
|------|-------------|-----------|----|----|
| 6463 | Pipe Cutter | COLOR BOX | 10 | 1 |



PVC Pipe Cutter

- Chrome Molybdenum Blade with Precision Ground Cutting Edge
- Rugged, Lightweight, Cast Aluminum Body with Durable Baked Enamel Finish
- High-Leverage Ratchet Action for Smooth Cuts with Less Effort
- 1-5/8" Jaw Capacity
- Cuts All Types of PVC and Plastic Pipes and Vinyl Tubing
- Fast, Square Cut with no Burrs to Remove or Mess to Clean Up
- Uses #6470 Replacement Blade

| Item | Description | Packaging | Cs | In |
|------|-----------------------|--------------------|----|----|
| 6466 | PVC Pipe Cutter | SLIDE BLISTER CARD | 24 | 6 |
| 6470 | PVC Pipe Cutter Blade | SKIN CARD | 96 | 24 |



Flaring Tool Set

- Precision-Machined, Threaded Steel Die Bar
- Six Die Sizes: 3/16", 1/4", 5/16", 3/8", 1/2", 5/8"
- Rugged, Solid Steel Yoke
- Hardened Center Screw with Sliding T-Bar Handle
- Produces 45° Flare Angle
- Use with Copper, Aluminum, and Thin-Walled Steel Tubing
- Ideal for Water, Gas, Refrigeration, and Brake Line Applications

| Item | Description | Packaging | Cs | In |
|------|------------------|--------------------|----|----|
| 6483 | Flaring Tool Set | SLIDE BLISTER CARD | 36 | 6 |

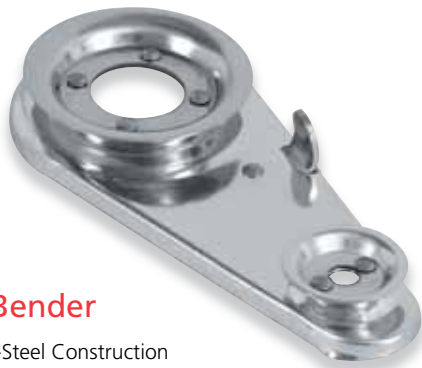

Tubing Bender

- Rugged All-Steel Construction
- Durable Chrome Plated Finish
- Smoothly Bends Thin-Walled Copper, Brass, and Aluminum Tubing without Crimping
- Dual-End Design Fits 3/16", 1/4", and 3/8" O.D. Tubing

| Item | Description | Packaging | Cs | In |
|------|---------------|--------------------|-----|----|
| 6515 | Tubing Bender | SLIDE BLISTER CARD | 100 | 10 |



15' Drain and Pipe Snake

- Hardened and Tempered 3/16" (5mm) Flat Steel Tape
- Flexible Spring Tip
- Easy-Coil Storage Reel
- Clears Drain Lines in Showers, Bathtubs, and Kitchen, Bath and Utility Sinks

| Item | Description | Packaging | Cs | In |
|------|--------------------------|-----------|----|----|
| 8065 | 15' Drain and Pipe Snake | HANG CARD | 96 | 12 |



10-pc. Double Flaring Tool Set

- Precision-Machined Steel Die Bar and Double Flare Adapters
- Drop Forged, Heat-Treated Steel Yoke
- Hardened Center Screw with Sliding T-Bar Handle
- Produces 45° Flare Angle
- Use with Copper, Aluminum, and Thin-Walled Steel Tubing
- Ideal for Water, Gas, Refrigeration, and Brake Line Applications

- 7-pc. Double Flare Adapters: 3/16", 1/4", 5/16", 3/8", 7/16", 1/2", 5/8"
- 1-pc. 7-Position Die Bar: 3/16", 1/4", 5/16", 3/8", 7/16", 1/2", 5/8"
- 1-pc. Flaring Yoke
- 1-pc. Organizer Carry Case

| Item | Description | Packaging | Cs | In |
|------|--------------------------------|-----------|----|----|
| 6490 | 10-pc. Double Flaring Tool Set | COLOR BOX | 24 | 1 |



Three-Size Tubing Bender

- Aluminum Alloy Construction with Durable Baked Enamel Finish
- Calibrated to Bend Angles up to 180°
- Smoothly Bends Copper, Brass, Aluminum, and Thin-Walled Steel Tubing without Crimping
- Three-Channel Design Fits 1/4", 5/16", and 3/8" O.D. Tubing
- Ideal for Water, Gas, Refrigeration, and Brake Line Applications

| Item | Description | Packaging | Cs | In |
|------|--------------------------|--------------------|----|----|
| 6519 | Three-Size Tubing Bender | SLIDE BLISTER CARD | 50 | 5 |

80 Staplers and Riveters

Rivet Gun with 40-pc. Rivets



- Rugged All-Steel Construction
- Durable Black Wrinkle Finish
- Non-Slip Cushioned Handle Grips
- Rivet Heads and Wrench Store in Handle
- Rust-Proof Aluminum Rivets
- Use for Sheet Metal, Automotive and Duct Work Applications

- 1-pc. Rivet Gun
- 10-pc. 3/32" x 1/4" Rivets
- 10-pc. 1/8" x 1/4" Rivets
- 10-pc. 5/32" x 1/4" Rivets
- 10-pc. 3/16" x 1/4" Rivets
- 4-pc. Rivet Heads
- 1-pc. Head Wrench

| Item | Description | Packaging | Cs | In |
|------|------------------------------|--------------------|----|----|
| 6555 | Rivet Gun with 40-pc. Rivets | SLIDE BLISTER CARD | 20 | 5 |



100-pc. Assorted Rivets

- Rust Proof Aluminum Heads with Steel Shanks
- Popular Size Blind Rivets Fit all Hand and Air Riveters, Foreign and Domestic

- 20-pc. 1/8" x 1/4"
- 30-pc. 1/8" x 5/16"
- 30-pc. 5/32" x 1/4"
- 20-pc. 3/16" x 5/16"

| Item | Description | Packaging | Cs | In |
|------|-------------------------|--------------------|----|----|
| 6565 | 100-pc. Assorted Rivets | SLIDE BLISTER CARD | 36 | 6 |



Compact Staple Gun

- Rugged, Impact-Resistant ABS Body
- Powerful Compact and Lightweight Design
- 100-Staple Capacity
- Accepts 5/32", 1/4", and 5/16" Staples
- Replacement Staples: Stanley® Sharpshooter™ TR45 or Arrow® JT21

- 1-pc. Staple Gun
- 100-pc. Staples

| Item | Description | Packaging | Cs | In |
|-------|--------------------|--------------------|----|----|
| 82581 | Compact Staple Gun | SLIDE BLISTER CARD | 48 | 6 |



5-pc. Jumbo Needle File Set

- Hardened and Tempered Alloy Steel Construction
- Precision-Milled Cutting Teeth
- Textured Non-Slip Poly Handles
- 7" Overall Length
- 1-pc. Tapered Round
- 1-pc. Tapered Triangle
- 1-pc. Tapered Square
- 1-pc. Warding
- 1-pc. Equaling

| Item | Description | Packaging | Cs | In |
|------|-----------------------------|--------------------|-----|----|
| 6652 | 5-pc. Jumbo Needle File Set | SLIDE BLISTER CARD | 100 | 10 |



5-pc. Jumbo Needle File Set

- Hardened and Tempered Alloy Steel Construction
- Precision-Milled Cutting Teeth
- Natural Hardwood Handles
- 7" Overall Length
- 1-pc. Tapered Round
- 1-pc. Tapered Triangle
- 1-pc. Tapered Square
- 1-pc. Tapered Half Round
- 1-pc. Equaling

| Item | Description | Packaging | Cs | In |
|------|-----------------------------|--------------------|----|----|
| 6654 | 5-pc. Jumbo Needle File Set | SLIDE BLISTER CARD | 72 | 12 |



10-pc. Needle File Set

- Hardened and Tempered Alloy Steel Construction
- Precision-Milled Cutting Teeth
- Comfortable Cushioned Non-Slip Handle Grip
- 5-1/2" Overall Length
- 1-pc. Oval
- 1-pc. Round
- 1-pc. Knife
- 1-pc. Half-Round
- 1-pc. Three Square
- 1-pc. Barrette
- 1-pc. Warding
- 1-pc. Equaling
- 1-pc. Square
- 1-pc. Crossing

| Item | Description | Packaging | Cs | In |
|------|------------------------|--------------------|-----|----|
| 6655 | 10-pc. Needle File Set | SLIDE BLISTER CARD | 100 | 10 |

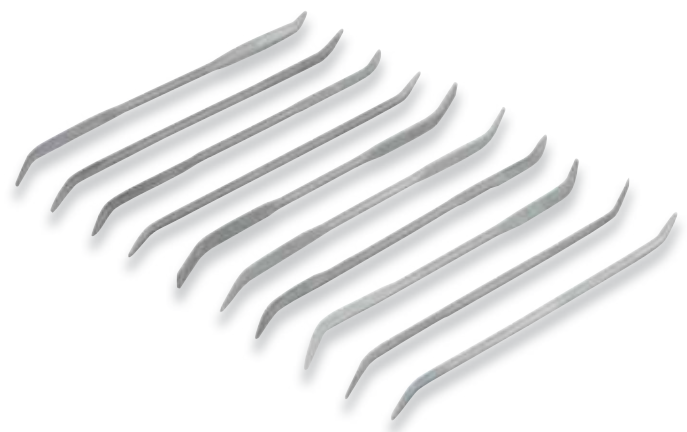

10-pc. Riffler Needle File Set

- Hardened and Tempered Alloy Steel Construction
- Double-End Curved Files with Precision Milled Cutting Teeth
- 5-1/2" Overall Length
- 1-pc. Oval
- 1-pc. Round
- 1-pc. Knife
- 1-pc. Half-Round
- 1-pc. Three Square
- 1-pc. Barrette
- 1-pc. Warding
- 1-pc. Equaling
- 1-pc. Square
- 1-pc. Crossing

| Item | Description | Packaging | Cs | In |
|------|--------------------------------|--------------------|-----|----|
| 6661 | 10-pc. Riffler Needle File Set | SLIDE BLISTER CARD | 100 | 10 |



12-pc. Professional File Set

- Hardened and Tempered Alloy Steel Construction
- Precision-Milled Cutting Teeth
- Extra-Large Contoured Polycast Handles for a Comfortable, Non-Slip Grip
- 1-pc. 10" Mill File
- 5-pc. 8" Files: Half-Round, Mill, Half-Round Wood Rasp, Round Wood Rasp, Flat
- 4-pc. 6" Files: 4-Way Shoe Rasp, Slim Taper, Extra Slim Taper, Round File
- 2-pc. Polycast Handles

| Item | Description | Packaging | Cs | In |
|------|------------------------------|-----------|----|----|
| 6665 | 12-pc. Professional File Set | COLOR BOX | 20 | 1 |



5-pc. Rotary Rasp Set

- Hardened Carbon Steel Construction
- Precision-Milled Cutting Teeth
- Universal Fit 1/4" Shanks
- Cuts and Shapes Soft and Hard Woods
- 1-pc. Short Cone
- 1-pc. Long Cone
- 1-pc. Cylinder
- 1-pc. Ball
- 1-pc. Oval

| Item | Description | Packaging | Cs | In |
|------|-----------------------|--------------------|----|----|
| 6669 | 5-pc. Rotary Rasp Set | SLIDE BLISTER CARD | 96 | 8 |



2-pc. 8" Chainsaw Files

- Hardened and Tempered Tool Steel Construction
- Precision Machined Cutting Teeth
- 2-pc. Chainsaw Files: 3/16" x 8" and 7/32" x 8"

| Item | Description | Packaging | Cs | In |
|------|-------------------------|--------------------|----|----|
| 6697 | 2-pc. 8" Chainsaw Files | SLIDE BLISTER CARD | 72 | 6 |



5-pc. 8" File Set

- Hardened and Tempered Carbon Steel
- Precision-Milled Cutting Teeth
- Oversized Comfortable Contoured Handles
- Sharpens, Shapes, and De-Burrs Metals and Polymers
- 8" Files, 12" Overall Length
- 1-pc. Flat
- 1-pc. Half Round
- 1-pc. Round
- 1-pc. Square
- 1-pc. Triangular

| Item | Description | Packaging | Cs | In |
|-------|-------------------|-----------------------|----|----|
| 66631 | 5-pc. 8" File Set | SEALED BLISTER - HALF | 20 | 10 |

Individual File Program

- Hardened and Tempered Tool Steel Construction
- Precision-Machined Cutting Teeth
- Oversized Contoured Poly Handle for a Sure, Comfortable Grip

| Item | Description | Packaging | Cs | In |
|------|--------------------------|--------------------|----|----|
| 6676 | 8" Flat File | WRAP CARD | 72 | 6 |
| 6677 | 10" Flat File | WRAP CARD | 48 | 6 |
| 6678 | 12" Flat File | WRAP CARD | 48 | 6 |
| 6679 | 8" Half Round File | WRAP CARD | 72 | 4 |
| 6680 | 10" Half Round File | WRAP CARD | 48 | 6 |
| 6681 | 12" Half Round File | WRAP CARD | 48 | 6 |
| 6682 | 6" Round File | WRAP CARD | 72 | 6 |
| 6683 | 8" Round File | WRAP CARD | 72 | 6 |
| 6684 | 10" Round File | WRAP CARD | 48 | 6 |
| 6686 | 6" Mill File | WRAP CARD | 72 | 4 |
| 6687 | 8" Mill File | WRAP CARD | 72 | 4 |
| 6688 | 10" Mill File | WRAP CARD | 48 | 4 |
| 6689 | 12" Mill File | WRAP CARD | 48 | 6 |
| 6690 | 6" Taper File | WRAP CARD | 72 | 6 |
| 6691 | 6" Slim Taper File | WRAP CARD | 72 | 6 |
| 6692 | 6" Extra Slim Taper File | WRAP CARD | 72 | 6 |
| 6693 | 8" Extra Slim Taper File | WRAP CARD | 72 | 6 |
| 6694 | 8" Half Round Wood Rasp | WRAP CARD | 72 | 6 |
| 6695 | 10" Half Round Wood Rasp | WRAP CARD | 48 | 6 |
| 6696 | 8" 4-Way Shoe Rasp File | SLIDE BLISTER CARD | 72 | 6 |

PACKAGING

- Hangs from Handle Hole
- Space-Saving Wrap-Around Tag Allows Hands-On Interaction with Product
- Easy-to-Read Size and Specifications on 4-Color Label



84 Punches and Chisels



4-pc. Pro Nail Sets

- Hardened and Tempered Carbon Steel Construction
- Ergonomically Designed, Cushioned Grips for Comfort and Precision Handling
- Precision-Machined Punch Tips
- Sets Nails Below Wood Surface for a Smooth, Finished Look
- 4-pc. Nail Sets: 1/32", 1/16", 3/32", 1/8"

| Item | Description | Packaging | Cs | In |
|------|---------------------|--------------------|----|----|
| 6574 | 4-pc. Pro Nail Sets | SLIDE BLISTER CARD | 72 | 6 |



3-pc. Nail Sets

- Precision-Machined Hardened Steel
- Knurled Shaft for Non-Slip Grip
- Tapered Square Striking Head Reduces Spalling
- Sets Nail Heads Below Wood Surface for a Professional Finish
- 3-pc. Nail Sets: 1/32", 1/16", 3/32"

| Item | Description | Packaging | Cs | In |
|------|-----------------|--------------------|-----|----|
| 6578 | 3-pc. Nail Sets | SLIDE BLISTER CARD | 144 | 6 |



4" Scratch Awl

- Hardened and Tempered Carbon Steel Shaft
- Corrosion-Resistant Chrome Plated Finish
- Contoured Natural Hardwood Handle
- Ultra-Fine Point Starts Pilot Holes, Punches Through-Holes, and Scribes Hard Surfaces

| Item | Description | Packaging | Cs | In |
|------|----------------|--------------------|-----|----|
| 6621 | 4" Scratch Awl | SLIDE BLISTER CARD | 240 | 12 |



Automatic Center Punch

- Heat-Treated Alloy Steel Point
- Brass Body, Black Oxide Finished Tip
- Knurled Handle for Sure Grip
- Automatically Strikes a Surface with Powerful Spring Action when Pressed
- Adjustable Cap Regulates Striking Force
- 5" Overall Length with a 1/2" Diameter Point
- Use to Start or Mark Holes for Drilling, Screwing and Riveting
- Keep Drills and Fasteners from Wandering

| Item | Description | Packaging | Cs | In |
|------|------------------------|--------------------|-----|----|
| 6580 | Automatic Center Punch | SLIDE BLISTER CARD | 252 | 12 |



28-pc. Transfer Punch Set

- Eliminates Guesswork when Transferring Threaded, Drilled, or Reamed Holes in Sheet Metal
- Hardened and Tempered Tool Steel Construction
- Black Oxide Finish for Durability
- 27-pc. Transfer Punch Sizes: 3/32" to 1/2" by 1/64th Increments
- 1-pc. 17/32" Punch
- 1-pc. Index Stand

| Item | Description | Packaging | Cs | In |
|------|---------------------------|-----------|----|----|
| 7319 | 28-pc. Transfer Punch Set | COLOR BOX | 12 | 1 |



Leather Punch

- Tempered Steel Punches
- Solid Brass Anvil
- Durable Chrome Plated Finish
- Comfortable Non-Slip Handle Grips
- Revolving Head for Quick Size Selection
- Punch Sizes: 3/32", 7/64", 1/8", 5/32", 11/64", 3/16"
- Punches Leather, Gaskets, Paper, Plastic, Vinyl, Cloth, and more

| Item | Description | Packaging | Cs | In |
|------|---------------|--------------------|----|----|
| 6585 | Leather Punch | SLIDE BLISTER CARD | 72 | 6 |



36-pc. 5/32" Letter and Number Stamp Set

- Hardened Chrome Vanadium Steel Punches
- Corrosion-Resistant Black Oxide Finish
- Includes A - Z and 0 - 9 Characters
- Imprints Metal, Wood, Plastic and Leather
- Length: 2-3/8"
- Width: 1/4"
- Character Height: 5/32"
- 36-pc. Punches: A - Z and 0 - 9
- Wood Index Box

| Item | Description | Packaging | Cs | In |
|------|--|-----------|----|----|
| 6610 | 36-pc. 5/32" Letter and Number Stamp Set | COLOR BOX | 24 | 6 |



36-pc. 5/16" Letter and Number Stamp Set

- Hardened Chrome Vanadium Steel Punches
- Corrosion-Resistant Black Oxide Finish
- Includes A - Z and 0 - 9 Characters
- Imprints Metal, Wood, Plastic and Leather
- Length: 2-1/2"
- Width: 3/8"
- Character Height: 5/16"
- 36-pc. Punches: A - Z and 0 - 9
- Wood Index Box

| Item | Description | Packaging | Cs | In |
|------|--|-----------|----|----|
| 6611 | 36-pc. 5/16" Letter and Number Stamp Set | COLOR BOX | 12 | 6 |

86 Punches and Chisels



6-pc. Hollow Punch Set

- Heat Treated Carbon Steel Construction
- Precision Ground Flute and Cutting Edge
- Non-Slip Knurled Handle Grip
- Cuts Clean Holes in Gaskets, Leather, Rubber, Cardboard, and Other Soft Materials
- 6-pc. Hollow Punches: 1/8", 5/32", 3/16", 7/32", 1/4", 5/16"

| Item | Description | Packaging | Cs | In |
|------|------------------------|-----------------------|----|----|
| 6586 | 6-pc. Hollow Punch Set | SEALED BLISTER - FULL | 72 | 6 |



9-pc. Hollow Punch Set

- Heat Treated Carbon Steel Construction
- Precision Ground Flute and Cutting Edge
- Non-Slip Knurled Handle Grip
- Cuts Clean Holes in Gaskets, Leather, Rubber, Cardboard, and Other Soft Materials
- 9-pc. Hollow Punches: 3/32", 1/8", 5/32", 3/16", 1/4", 5/16", 3/8", 7/16", 1/2"
- Complete with Organizer Storage Pouch

| Item | Description | Packaging | Cs | In |
|------|------------------------|-------------|----|----|
| 6587 | 9-pc. Hollow Punch Set | POUCH/LABEL | 48 | 6 |

12-pc. Hollow Punch Set

- Heat Treated Carbon Steel Construction
- Precision Ground Flute and Cutting Edge
- Non-Slip Knurled Handle Grip
- Cuts Clean Holes in Gaskets, Leather, Rubber, Cardboard, and Other Soft Materials
- 12-pc. Hollow Punches: 1/8", 5/32", 3/16", 7/32", 1/4", 5/16", 3/8", 7/16", 1/2", 9/16", 5/8", 3/4"
- Complete with Organizer Storage Pouch

| Item | Description | Packaging | Cs | In |
|------|-------------------------|-------------|----|----|
| 6588 | 12-pc. Hollow Punch Set | POUCH/LABEL | 20 | 5 |





4-pc. Extra Long Taper Punch Set

- Machined from High Carbon Hex Stock Steel
- Precision Ground and Polished Tapered Tips
- Black Oxide Finish Resists Corrosion
- 4-pc. Long Tapered Punches 3/16" x 8" Tapered Punch 3/16" x 12" Tapered Punch 1/4" x 12" Tapered Punch 1/4" x 14-3/4" Tapered Punch

| Item | Description | Packaging | Cs | In |
|------|----------------------------------|-----------------------|----|----|
| 6737 | 4-pc. Extra Long Taper Punch Set | SEALED BLISTER - FULL | 16 | 4 |



12-pc. Cold Chisel and Punch Set

- Forged and Hardened Carbon Steel Construction
- Precision Ground and Polished Blades
- Heavy-Duty Hex Stock Shanks
- Durable Baked Enamel Finish
- 6-pc. Cold Chisels: 1/2" x 7", 5/8" x 7", 3/4" x 8", 7/8" x 8", 7/8" x 10", 1" x 10"
- 1-pc. Pin Punch: 3/8" x 8"
- 3-pc. Tapered Punches: 1/8" x 6", 3/16" x 10", 3/8" x 10"
- 2-pc. Tapered Center Punches: 1/8" x 6", 1/4" x 8"
- Complete with Roll-up Storage Pouch

| Item | Description | Packaging | Cs | In |
|------|----------------------------------|-----------|----|----|
| 6738 | 12-pc. Cold Chisel and Punch Set | COLOR BOX | 8 | 4 |



6-pc. Pin Punch Set

- Machined from Heat Treated Hex Stock Alloy Steel
- Precision Ground and Polished
- Tapered Striking Head Reduces Spalling
- 6-pc. Pin Punches: 3/32" x 4-1/4", 1/8" x 4-3/4", 5/32" x 5", 3/16" x 5-1/4", 1/4" x 5-3/4", 5/16" x 6-1/4"

| Item | Description | Packaging | Cs | In |
|------|---------------------|--------------------|----|----|
| 6739 | 6-pc. Pin Punch Set | SLIDE BLISTER CARD | 36 | 6 |



16-pc. Punch and Chisel Set

- Machined from Heat Treated Hex Stock Alloy Steel
- Precision Ground and Polished
- Tapered Striking Head Reduces Spalling
- 3-pc. Cold Chisels: 3/8" x 5-1/2", 1/2" x 6", 5/8" x 6-1/2"
- 2-pc. Center Punches: 1/8" x 5", 3/16" x 6"
- 5-pc. Taper Punches: 3/32" x 5-1/4", 1/8" x 4-3/4", 5/32" x 5", 3/16" x 5-1/4", 1/4" x 5-3/4"
- 5-pc. Pin Punches: 3/32" x 4-1/4", 1/8" x 4-3/4", 5/32" x 5", 3/16" x 5-1/4", 1/4" x 5-3/4"
- 1-pc. Chisel Punch Gauge

| Item | Description | Packaging | Cs | In |
|------|-----------------------------|-----------------------|----|----|
| 6740 | 16-pc. Punch and Chisel Set | SEALED BLISTER - FULL | 20 | 5 |

Individual Punch and Chisel Program

| Item | Description | Packaging | Cs | In |
|------|--------------------|--------------------|----|----|
| 6716 | 1/4" Cold Chisel | SLIDE BLISTER CARD | 36 | 6 |
| 6717 | 3/8" Cold Chisel | SLIDE BLISTER CARD | 36 | 6 |
| 6718 | 1/2" Cold Chisel | SLIDE BLISTER CARD | 36 | 6 |
| 6719 | 5/8" Cold Chisel | SLIDE BLISTER CARD | 36 | 6 |
| 6720 | 3/4" Cold Chisel | SLIDE BLISTER CARD | 36 | 6 |
| 6721 | 7/8" Cold Chisel | SLIDE BLISTER CARD | 36 | 6 |
| 6722 | 3/32" Pin Punch | SLIDE BLISTER CARD | 36 | 6 |
| 6723 | 1/8" Pin Punch | SLIDE BLISTER CARD | 36 | 6 |
| 6724 | 3/16" Pin Punch | SLIDE BLISTER CARD | 36 | 6 |
| 6726 | 1/4" Pin Punch | SLIDE BLISTER CARD | 36 | 6 |
| 6727 | 1/8" Taper Punch | SLIDE BLISTER CARD | 36 | 6 |
| 6728 | 3/16" Taper Punch | SLIDE BLISTER CARD | 36 | 6 |
| 6729 | 1/8" Center Punch | SLIDE BLISTER CARD | 36 | 6 |
| 6730 | 3/16" Center Punch | SLIDE BLISTER CARD | 36 | 6 |
| 6731 | 3/32" Center Punch | SLIDE BLISTER CARD | 36 | 6 |

- Precision Ground and Polished Blade
- Machined from High Carbon Hex Stock Steel
- Cushioned Grip Reduces Vibration Fatigue
- Tapered Striking Head Reduces Spalling

PACKAGING

- Fully enclosed slide blister packaging, with attractive color card, protects product and prevents contact with sharp edges.



7-pc. Punch and Chisel Set

- Precision Ground and Polished Blades and Punch Tips
- Machined from High Carbon Hex Stock Steel
- Cushioned Grip Reduces Vibration Fatigue
- Tapered Striking Head Reduces Spalling
- 6" Length
- 2-pc. Taper Punches: 1/8", 3/16"
- 1-pc. Pin Punch: 3/16"
- 1-pc. Center Punch: 3/8"
- 3-pc. Cold Chisels: 3/8", 1/2", 5/8"

| Item | Description | Packaging | Cs | In |
|------|----------------------------|-----------------------|----|----|
| 6725 | 7-pc. Punch and Chisel Set | SEALED BLISTER - FULL | 40 | 5 |





8-pc. Mini Wood Carving Chisel Set

- Precision-Ground Steel Blades
- 4" Natural Wood Handles
- Metal Ferrules Prevent Handle Splitting
- 1" Blade, 5" Overall Length
- Cuts and Shapes Soft Woods, Soap, Clay and other Modeling and Hobby Materials
- 3-pc. Skew Chisel: 5/64", 3/16", 1/4"
- 2-pc. Straight Chisel: 1/4", 13/32"
- 1-pc. Round Chisel: 13/32"
- 1-pc. 90° V-Parting Chisel: 1/4"
- 1-pc. Gouge Chisel: 3/16"

| Item | Description | Packaging | Cs | In |
|------|------------------------------------|--------------------|-----|----|
| 6741 | 8-pc. Mini Wood Carving Chisel Set | SLIDE BLISTER CARD | 100 | 10 |



11-pc. Wood Carving Chisel Set

- Hardened Carbon Steel Shafts
- Precision-Ground Cutting Edges
- 3" Contoured Natural Hardwood Handles
- Cuts and Shapes Soft Woods
- 2-1/2" Blades, 5-1/2" Overall Length
- 1-pc. Spoon Gouge
- 1-pc. Small V-parting
- 1-pc. Large V-parting
- 1-pc. Small Mortising
- 1-pc. Large Mortising
- 1-pc. Small Gouge
- 1-pc. Large Gouge
- 1-pc. Small Skew
- 1-pc. Large Skew
- 1-pc. Small Firmer
- 1-pc. Large Firmer

| Item | Description | Packaging | Cs | In |
|------|--------------------------------|-----------------------|----|----|
| 6742 | 11-pc. Wood Carving Chisel Set | SEALED BLISTER - FULL | 20 | 5 |



3-pc. Wood Chisel Set

- Drop Forged, Heat Treated Steel
- Precision-Machined Blade and Beveled Cutting Edge
- Lacquer Coating Protects and Lubricates Blade for Smooth Cutting
- Durable Hardwood Handle
- 3-pc. Wood Chisel: 1/2", 3/4", 1"

| Item | Description | Packaging | Cs | In |
|------|-----------------------|--------------------|----|----|
| 6745 | 3-pc. Wood Chisel Set | SLIDE BLISTER CARD | 40 | 5 |



4-pc. Wood Chisel Set

- Drop Forged, Heat Treated Steel
- Precision-Machined Blade and Beveled Cutting Edge
- Lacquer Coating Protects and Lubricates Blade for Smooth Cutting
- Full-Size High-Impact Handle
- 4-pc. Wood Chisels: 1/4", 1/2", 3/4", 1"

| Item | Description | Packaging | Cs | In |
|------|-----------------------|--------------------|----|----|
| 6758 | 4-pc. Wood Chisel Set | SLIDE BLISTER CARD | 40 | 5 |

90 Punches and Chisels

PACKAGING

- Fully enclosed slide blister packaging, with attractive color card, protects product and prevents contact with sharp edges.



Individual Wood Chisel Program

- Drop Forged, Heat Treated Alloy Steel
- Precision-Machined Blade and Beveled Cutting Edge
- Lacquer Coating Protects and Lubricates Blade for Smooth Cutting
- Contoured, High-Impact Handle

| Item | Description | Packaging | Cs | In |
|------|--------------------|--------------------|----|----|
| 6751 | 1/4" Wood Chisel | SLIDE BLISTER CARD | 36 | 6 |
| 6752 | 3/8" Wood Chisel | SLIDE BLISTER CARD | 36 | 6 |
| 6753 | 1/2" Wood Chisel | SLIDE BLISTER CARD | 36 | 6 |
| 6754 | 3/4" Wood Chisel | SLIDE BLISTER CARD | 36 | 6 |
| 6755 | 1" Wood Chisel | SLIDE BLISTER CARD | 36 | 6 |
| 6756 | 1-1/4" Wood Chisel | SLIDE BLISTER CARD | 36 | 6 |
| 6757 | 1-1/2" Wood Chisel | SLIDE BLISTER CARD | 36 | 6 |



3-pc. Wood Chisel Set

- Drop Forged, Heat Treated Alloy Steel
- Precision-Machined Blade and Beveled Cutting Edge
- Lacquer Coating Protects and Lubricates Blade for Smooth Cutting
- Contoured, High-Impact Handle
- 3-pc. Wood Chisels: 1/2", 3/4", 1"

| Item | Description | Packaging | Cs | In |
|------|-----------------------|-----------------------|----|----|
| 6749 | 3-pc. Wood Chisel Set | SEALED BLISTER - FULL | 18 | 6 |

Heavy Duty Close Quarter Hacksaw

- Tough ABS Handle Construction
- Adjusts Blade Length to Fit into Tight Work Areas
- Knurled Steel Thumbscrew Locks Blade Position
- Accepts any Length Hacksaw Blade
- Includes Two 12" (18 TPI) High Carbon Steel Blades



| Item | Description | Packaging | Cs | In |
|------|----------------------------------|-----------|-----|----|
| 6798 | Heavy Duty Close Quarter Hacksaw | HANG CARD | 120 | 12 |



Aluminum Frame Junior Hacksaw

- Compact, Light Duty Hacksaw for Tight Work Areas and Small Projects
- Lightweight, One-Piece Aluminum Frame
- Comfortable, Contoured Pistol Grip Handle
- Thumbscrew Receiver Applies Blade Tension
- Includes One 6" (18 TPI) Blade

| Item | Description | Packaging | Cs | In |
|------|-------------------------------|-------------|----|----|
| 6800 | Aluminum Frame Junior Hacksaw | COLOR LABEL | 48 | 4 |



6" Junior Coping Hacksaw

- Compact, Light Duty Hacksaw for Tight Work Areas and Small Projects
- One-Piece High-Impact ABS Frame
- Lever-Type Blade Receiver Applies Higher Tension
- Includes One 6" (24 TPI) Metal Cutting Blade and One 6" (24 TPI) Wood Cutting Blade

| Item | Description | Packaging | Cs | In |
|------|--------------------------|--------------------|----|----|
| 6803 | 6" Junior Coping Hacksaw | SLIDE BLISTER CARD | 72 | 6 |

6" Junior Hacksaw

- Compact, Light Duty Hacksaw for Tight Work Areas and Small Projects
- One-Piece Chrome Plated Steel Frame
- Includes Six 6" (24 TPI) Blades

| Item | Description | Packaging | Cs | In |
|------|-------------------|-----------|-----|----|
| 6801 | 6" Junior Hacksaw | HANG CARD | 120 | 12 |

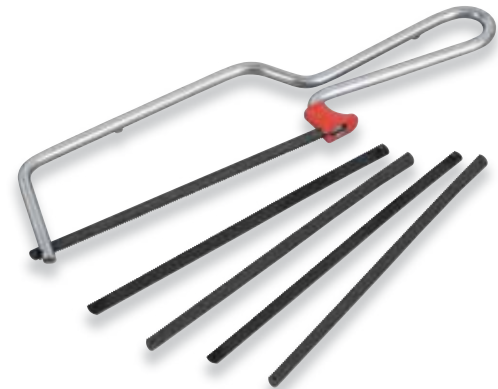

6" Pistol-Grip Junior Hacksaw

- Compact, Light Duty Hacksaw for Tight Work Areas and Small Projects
- Metal and Poly Frame with Comfortable Pistol Grip Handle
- Thumbscrew Receiver Applies Blade Tension
- Includes One 6" (24 TPI) Blade

| Item | Description | Packaging | Cs | In |
|------|-------------------------------|-----------|-----|----|
| 6804 | 6" Pistol-Grip Junior Hacksaw | HANG CARD | 144 | 12 |



Adjustable Hacksaw

- Rugged All-Steel Construction
- Corrosion-Resistant Triple Chrome Plated Finish
- Comfortable Pistol-Grip Handle
- Wingnut Blade Tensioner
- Adjustable Frame Accepts 8", 10", or 12" Blades
- Includes 12" (24 TPI) Carbon Steel Blade

| Item | Description | Packaging | Cs | In |
|------|--------------------|------------------|----|----|
| 6815 | Adjustable Hacksaw | BULK/COLOR LABEL | 36 | 6 |



Adjustable Hacksaw

- Rugged All-Steel Construction
- Corrosion-Resistant Triple Chrome Plated Finish
- Comfortable Non-Slip Cushioned Handle Grip
- Wingnut Blade Tensioner
- Adjustable Frame Accepts 8", 10", or 12" Blades
- Includes 12" (24 TPI) Carbon Steel Blade

| Item | Description | Packaging | Cs | In |
|------|--------------------|------------------|----|----|
| 6816 | Adjustable Hacksaw | BULK/COLOR LABEL | 36 | 6 |



4-in-1 Deluxe Hacksaw Set

- Three-Position Adjustable Steel Frame Fits 8", 10", and 12" Blades
- Triple Chrome Plated Finish Resists Corrosion
- Non-Slip Cushioned Handle Grip
- Compact Close Quarters Handle Holds Blade at Any Length to Fit into Tight Work Areas
- Includes One Dual-Edge (18 TPI / 24 TPI) High Carbon Steel Blade

| Item | Description | Packaging | Cs | In |
|------|---------------------------|-----------|----|----|
| 6817 | 4-in-1 Deluxe Hacksaw Set | WRAP CARD | 36 | 6 |



High-Tension Angle Hacksaw

- Rugged Cast Aluminum Alloy Frame
- Rigid Square Tubular Steel Main Beam Prevents Twisting
- Adjust Blade Tension up to 400lbs.
- Two Blade Positions: 0° Normal Cut, 45° Flush Cut
- 12" (18 TPI) Flexible Bi-Metal Blade

| Item | Description | Packaging | Cs | In |
|------|----------------------------|--------------|----|----|
| 6822 | High-Tension Angle Hacksaw | COLOR SLEEVE | 36 | 6 |

6-pc. 12" Hacksaw Blade Set

- Two Blades Each of 18, 24, and 32 Teeth per Inch
- Hardened and Tempered High-Carbon Steel
- Universal Replacement Blades for 12" Hacksaw Frames

| Item | Description | Packaging | Cs | In |
|------|-----------------------------|------------------------|-----|----|
| 6825 | 6-pc. 12" Hacksaw Blade Set | PLASTIC HANG TAB/LABEL | 200 | 10 |



Carbon Steel Hacksaw Blades

6830

- 18 Teeth per Inch
- Hardened and Tempered High-Carbon Steel
- Universal Replacement Blades for 12" Hacksaw Frames

6831

- 24 Teeth per Inch
- Hardened and Tempered High-Carbon Steel
- Universal Replacement Blades for 12" Hacksaw Frames

| Item | Description | Packaging | Cs | In |
|------|-----------------------------------|--------------|------|-----|
| 6830 | 10-pc. 12" x 18 TPI Hacksaw Blade | COLOR SLEEVE | 1200 | 120 |
| 6831 | 10-pc. 12" x 24 TPI Hacksaw Blade | COLOR SLEEVE | 1200 | 120 |



Bi-Metal Hacksaw Blades

6832

- 18 Teeth per Inch
- Professional Grade Bi-Metal Blades for Faster Cuts and Longer Life
- Universal Replacement Blades for 12" Hacksaw Frames

6833

- 24 Teeth per Inch
- Professional Grade Bi-Metal Blades for Faster Cuts and Longer Life
- Universal Replacement Blades for 12" Hacksaw Frames

6834

- 32 Teeth per Inch
- Professional Grade Bi-Metal Blades for Faster Cuts and Longer Life
- Universal Replacement Blades for 12" Hacksaw Frames

| Item | Description | Packaging | Cs | In |
|------|--|--------------------|----|----|
| 6832 | 2-pc. 12" x 18 TPI Bi-Metal Hacksaw Blades | SLIDE BLISTER CARD | 72 | 36 |
| 6833 | 2-pc. 12" x 24 TPI Bi-Metal Hacksaw Blades | SLIDE BLISTER CARD | 72 | 6 |
| 6834 | 2-pc. 12" x 32 TPI Bi-Metal Hacksaw Blades | SLIDE BLISTER CARD | 72 | 6 |





6" Cushion Grip Wallboard Saw

- Tempered 6" Heavy Duty Steel Blade
- Oversized, Non-Slip, Cushion Grip Handle
- Aggressive Offset Teeth for Quick, Accurate Cuts
- Sharpened Tip Punches Directly Through Drywall to Start Cut

| Item | Description | Packaging | Cs | In |
|------|-------------------------------|-----------|----|----|
| 6861 | 6" Cushion Grip Wallboard Saw | HANG CARD | 72 | 6 |



6" Wallboard Saw

- Tempered 6" Steel Blade
- Comfortable Countoured Hardwood Handle
- Aggressive Offset Teeth for Quick, Accurate Cuts
- Sharpened Tip Punches Directly Through Drywall to Start Cut

| Item | Description | Packaging | Cs | In |
|------|------------------|-----------|-----|----|
| 6862 | 6" Wallboard Saw | HANG CARD | 100 | 10 |



10" Compass Saw

- Tempered Steel Blade
- Aggressive Teeth for Fast Cuts
- 8 Teeth per Inch
- Comfortable Contoured Hardwood Handle
- Cuts Precise Curves and Angles in Wood, Plasterboard, and Plywood

| Item | Description | Packaging | Cs | In |
|------|-----------------|--------------|----|----|
| 6863 | 10" Compass Saw | COLOR SLEEVE | 96 | 6 |



6-3/4" Coping Saw

- Nickel Plated Steel Frame Construction
- Contoured Wood Handle for a Comfortable Grip
- Hardened and Tempered, High-Carbon Steel Blades
- 6-3/4" Pin-End Blades Adjust for Angled Cuts
- 5-pc. 6" High-Carbon Steel Blades
- 2-pc. Medium Blades for Cutting Wood
- 1-pc. Fine for Cutting Thick Metal and Hardwood
- 1-pc. Extra Fine for Thin Metal and Thin Wood
- 1-pc. Hacksaw Blade for all Metals
- 1-pc. Coping Saw Frame

| Item | Description | Packaging | Cs | In |
|------|-------------------|-----------|----|----|
| 6865 | 6-3/4" Coping Saw | WRAP CARD | 72 | 6 |



7-pc. Deep Hole Saw Set

- Tempered Steel Blades
- Aggressive Teeth for Fast Precise Cuts
- 1-1/2" Cutting Depth
- 1/4" Pilot Bit
- 1/4" Shank Fits All Drills

- 7-pc. Deep Hole Saw: 1", 1-1/4", 1-1/2", 1-3/4", 2", 2-1/4", 2-1/2"
- Complete with 1/4" Mandrel

| Item | Description | Packaging | Cs | In |
|------|-------------------------|-----------------------|----|----|
| 6881 | 7-pc. Deep Hole Saw Set | SEALED BLISTER - FULL | 60 | 6 |



4-pc. Contractor Hole Saw Set

- Tempered High Carbon Steel Blades
- Aggressive Teeth for Fast Precise Cuts
- 3/4" Cutting Depth
- 1/4" Pilot Bit
- 1/4" Shank Fits All Drills

- 4-pc. Contractor Hole Saw: 1-1/4", 1-1/2", 1-3/4", 2-1/8"
- Complete with 1/4" Mandrel

| Item | Description | Packaging | Cs | In |
|------|-------------------------------|-----------------------|----|----|
| 6884 | 4-pc. Contractor Hole Saw Set | SEALED BLISTER - FULL | 60 | 6 |



5-pc. Jigsaw Blade Set

- Tempered High-Carbon Steel Blades
- Universal Shank Fits Most Saws
- Color Coded Blade Types
- 5-pc. Jigsaw Blades:
 - 3" x 8 TPI (Yellow): Wood
 - 3" x 10 TPI (Orange): Wood, Plywood
 - 3" x 12 TPI (Violet): Plywood
 - 3" x 14 TPI (Green): Plywood, Paneling
 - 2" x 24 TPI (Red): Metal

| Item | Description | Packaging | Cs | In |
|------|------------------------|--------------------|-----|----|
| 6885 | 5-pc. Jigsaw Blade Set | SLIDE BLISTER CARD | 144 | 12 |



8-pc. Jigsaw Blade Set

- Tempered High-Carbon Steel Blades
- Universal Shank Fits Most Saws
- Color Coded Blade Types
- 8-pc. Jigsaw Blades:
 - 5" x 8 TPI (Blue): Thick Wood
 - 2-1/2" x 8 TPI (Blue): Flush Cut Wood
 - 3" x 8 TPI (Yellow): Wood
 - 3" x 10 TPI (Violet): Wood, Plywood
 - 3" x 12 TPI (Green): Plywood, Paneling
 - 2-1/2" x 14 TPI (Orange): Scroll Cut
 - 2" x 24 TPI (Red): Metal
 - 3" Knife (Black): Leather, Canvas

| Item | Description | Packaging | Cs | In |
|------|------------------------|--------------------|-----|----|
| 6890 | 8-pc. Jigsaw Blade Set | SLIDE BLISTER CARD | 144 | 12 |

NEW



10-pc. Reciprocating Saw Blades

- Longer Lasting Bi-Metal Blades for Sheet Metal, Re-bar, and Pipes
- Rugged Tempered High-Carbon Steel Blades for Wood and General Purpose Demolition
- Standard Duty .040" Thick Blades
- 4-pc. 6" (6TPI) Wood/Demolition Blades
- 2-pc. 6" (10TPI) Wood Blades
- 2-pc. 6" (18TPI) Metal Blades
- 2-pc. 8" (6TPI) Wood/Demolition Blades

| Item | Description | Packaging | Cs | In |
|------|---------------------------------|-----------------------|----|----|
| 6892 | 10-pc. Reciprocating Saw Blades | SEALED BLISTER - FULL | 40 | 5 |

NEW



14-pc. Reciprocating Saw Blade Kit

- Longer Lasting Bi-Metal Blades for Sheet Metal, Re-bar, and Pipes
- Rugged Tempered High-Carbon Steel Blades for Wood and General Purpose Demolition
- Standard Duty .040" Thick Blades
- 2-pc. 4" (14TPI) Metal Blades
- 2-pc. 4" (24TPI) Metal Blades
- 2-pc. 6" (18TPI) Masonite®/Metal Blades
- 2-pc. 6" (7TPI) Wood/Demolition Blades
- 2-pc. 8" (7TPI) Wood/Demolition Blades
- 2-pc. 9" (6TPI) Wood/Demolition Blades
- 2-pc. 12" (6TPI) Wood/Demolition Blades
- Complete with Roll-Up Storage Pouch

| Item | Description | Packaging | Cs | In |
|------|------------------------------------|-----------------------|----|----|
| 6893 | 14-pc. Reciprocating Saw Blade Kit | SEALED BLISTER - FULL | 40 | 4 |



15" Tool Box Saw

- Contractor Grade Heavy Gauge Steel Blade
- Aggressive, Fully Sharpened Teeth Cut Faster
- Induction Hardened Teeth Stay Sharp Longer
- Soft, Comfortable, Non-Slip Finger Grip Handle Reduces Fatigue
- Compact 18" Overall Size for Easy Tool Box Storage
- 8 Teeth per Inch

| Item | Description | Packaging | Cs | In |
|------|------------------|--------------|----|----|
| 6852 | 15" Tool Box Saw | COLOR SLEEVE | 72 | 6 |



15" Tool Box Saw

- Heavy Gauge Steel Blade
- Aggressive, Fully Sharpened Teeth Cut Faster
- Induction Hardened Teeth Stay Sharp Longer
- Compact 17" Overall Size for Easy Tool Box Storage
- 8 Teeth per Inch

| Item | Description | Packaging | Cs | In |
|-------|------------------|--------------|----|----|
| 82576 | 15" Tool Box Saw | COLOR SLEEVE | 72 | 6 |



14" Back Saw

- Spring Steel Blade with Flex-Resistant Rolled Spine
- Fully File-Sharpended Teeth for Fine Finish Cuts
- Induction Hardened Teeth Stay Sharp Longer
- Comfortable Contoured ABS Handle
- Use Alone or with Many Miter Box Styles
- 14" Blade, 18" Overall Length
- 9 Teeth per Inch

| Item | Description | Packaging | Cs | In |
|-------|--------------|--------------|----|----|
| 80835 | 14" Back Saw | COLOR SLEEVE | 48 | 6 |



12" Deluxe Bow Hacksaw

- Rugged Tubular Steel Frame with Durable Baked Enamel Finish
- Quick-Release Locking Cam Handle Allows Fast Blade Changes and Applies Higher Blade Tension
- Steel Handle Guard Helps Protect Fingers from Branches, Thorns and Other Debris while Cutting
- Includes Two Blades: Deep-Tooth, File Sharpened Wood Blade and 12" (18 TPI) Hacksaw Blade

| Item | Description | Packaging | Cs | In |
|------|------------------------|--------------|----|----|
| 7914 | 12" Deluxe Bow Hacksaw | COLOR SLEEVE | 24 | 6 |

Snap-Off Knife Blade Refills

6902

- 12-Point Tempered Spring Steel Blades
- Universal Snap-Off Knife Replacement Blades
- Complete with Storage Case

6903

- 8-Point Tempered Spring Steel Blades
- Universal Snap-Off Knife Replacement Blades
- Complete with Storage Case

| Item | Description | Packaging | Cs | In |
|------|---|--------------------|-----|----|
| 6902 | 10-pc. Compact Snap-Off Knife Blade Refills | SLIDE BLISTER CARD | 288 | 12 |
| 6903 | 10-pc. Snap-Off Knife Blade Refills | SLIDE BLISTER CARD | 288 | 12 |

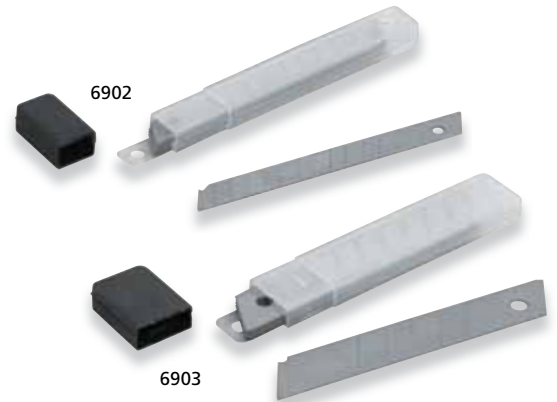

Compact Snap-Off Knives

- Impact-Resistant ABS Housing
- Tempered Spring Steel Blade
- Snap Off Used Blades for a New Cutting Edge
- Fully Retractable Blade Locks in any Position
- Accepts Universal Replacement Blades

6905

- 60-pc. Small Snap-Off Knife Display (30-pc. Red, 30-pc. Black)

- AVAILABLE IN DISPLAY QUANTITIES ONLY

| Item | Description | Packaging | Cs | In |
|-------|------------------------|--------------------|-----|----|
| 6905 | Compact Snap-Off Knife | 60-PC. DISPLAY BOX | 20 | 1 |
| 96900 | Compact Snap-Off Knife | SLIDE BLISTER CARD | 288 | 12 |



Snap-Off Knives

- Impact-Resistant ABS Housing
- Tempered Spring Steel Blade
- Snap Off Used Blades for a New Cutting Edge
- Fully Retractable Blade Locks in any Position
- Accepts Universal Replacement Blades

6912

- 24-pc. Large Snap-Off Knife Display (12-pc. Red, 12-pc. Black)

- AVAILABLE IN DISPLAY QUANTITIES ONLY

| Item | Description | Packaging | Cs | In |
|-------|----------------|--------------------|-----|----|
| 6912 | Snap-Off Knife | 24-PC. DISPLAY BOX | 20 | 1 |
| 96910 | Snap-Off Knife | SLIDE BLISTER CARD | 288 | 12 |



3-pc. Snap-Off Knife Set

- Impact-Resistant ABS Housing
- Tempered Spring Steel Blade
- Snap Off Used Blades for a New Cutting Edge
- Fully Retractable Blade Locks in any Position
- Accepts Universal Replacement Blades

- 1-pc. Large Snap-Off Knife
- 2-pc. Small Snap-Off Knife

| Item | Description | Packaging | Cs | In |
|-------|--------------------------|--------------------|-----|----|
| 96907 | 3-pc. Snap-Off Knife Set | SLIDE BLISTER CARD | 144 | 12 |

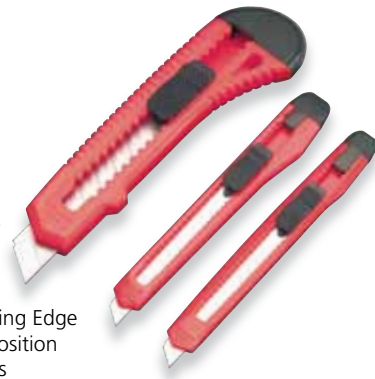

8-pc. Snap-Off Knife and Scraper Set

- All-Purpose Assortment of Utility Knives, Scrapers, and Cutters
- Ideal for Household, Garage, and Workplace Use

- 1-pc. Small Snap-Off Knife
- 1-pc. Large Snap-Off Knife
- 1-pc. Medium Snap-Off Knife
- 1-pc. Mini Snap-Off Knife
- 1-pc. Retractable Utility Knife
- 1-pc. Retractable Safety Scraper
- 1-pc. Utility Scraper
- 1-pc. Mini Box Cutter

| Item | Description | Packaging | Cs | In |
|-------|--------------------------------------|-----------------------|-----|----|
| 96909 | 8-pc. Snap-Off Knife and Scraper Set | SEALED BLISTER - FULL | 120 | 12 |





Easy-Open Retractable Utility Knife

- Easy-Open, Heavy Duty, Zinc Alloy Housing for Fast Blade Replacement
- Non-Slip Rubber Handle Grips
- Fully Retractable Blade Adjusts to Three Cutting Positions
- Double Overlap Blade Guard
- Accepts Universal Replacement Utility Knife Blades

- 1-pc. Utility Knife
- 3-pc. Blades

| Item | Description | Packaging | Cs | In |
|-------|-------------------------------------|----------------------|-----|----|
| 96914 | Easy-Open Retractable Utility Knife | COLOR POLY HANG CARD | 120 | 12 |



Retractable Utility Knife

- Rugged Aluminum Housing Weighs 50% Less than Standard Zinc Housing
- Fully Retractable Blade Adjusts to Three Cutting Positions
- Double Overlap Blade Guard
- Accepts Universal Replacement Utility Knife Blades

- 1-pc. Utility Knife
- 2-pc. Blades

| Item | Description | Packaging | Cs | In |
|-------|---------------------------|----------------------|-----|----|
| 96915 | Retractable Utility Knife | COLOR POLY HANG CARD | 120 | 12 |



Heavy Duty Retractable Utility Knife

- Rugged Aluminum Housing Weighs 50% Less than Standard Zinc Housing
- Fully Retractable Blade Adjusts to Eight Cutting Positions
- Double Overlap Blade Guard
- Accepts Universal Replacement Utility Knife Blades

- 1-pc. Utility Knife
- 5-pc. Blades

| Item | Description | Packaging | Cs | In |
|-------|--------------------------------------|----------------------|----|----|
| 96916 | Heavy Duty Retractable Utility Knife | COLOR POLY HANG CARD | 72 | 6 |



Retractable Utility Knife

- Rugged Aluminum Housing Weighs 50% Less than Standard Zinc Housing
- Fully Retractable Blade Adjusts to Three Cutting Positions
- Double Overlap Blade Guard
- Accepts Universal Replacement Utility Knife Blades

- 1-pc. Utility Knife
- 2-pc. Blades

| Item | Description | Packaging | Cs | In |
|-------|---------------------------|----------------------|-----|----|
| 96917 | Retractable Utility Knife | COLOR POLY HANG CARD | 120 | 12 |



Folding Utility Knife

- Quick-Change, Push-Button Release for the Fastest Blade Change Available
- Convenient Handle Compartment Holds up to 6 Extra Blades
- Liner-Lock Design for Safe Operation and One-Handed Opening
- Compact Closed Size Fits Easily in Any Pocket
- Contoured Handle Reduces Fatigue
- Comfortable Padded Thumb Rest
- Finger Profile for Precise Blade Control
- Complete with Belt Holster and 5 Bonus Blades

- 1-pc. Folding Utility Knife
- 1-pc. Belt Holster
- 5-pc. Bonus Blades

| Item | Description | Packaging | Cs | In |
|-------|-----------------------|-----------------------|----|----|
| 69184 | Folding Utility Knife | SEALED BLISTER - FULL | 72 | 6 |



5-pc. Utility Knife Blades

- SK5 Spring Steel Standard Duty (0.50 mm) Utility Blades
- Universal Replacement Blades fit Most Utility Knives

| Item | Description | Packaging | Cs | In |
|------|----------------------------|--------------------|------|----|
| 6920 | 5-pc. Utility Knife Blades | SLIDE BLISTER CARD | 1000 | 50 |

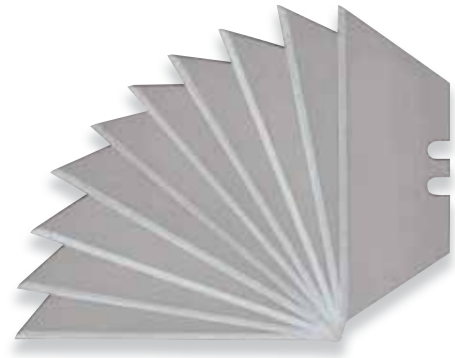

10-pc. Utility Knife Blades

- SK5 Spring Steel Standard Duty (0.50 mm) Utility Blades
- Universal Replacement Blades fit Most Utility Knives

| Item | Description | Packaging | Cs | In |
|------|-----------------------------|--------------------|-----|----|
| 6921 | 10-pc. Utility Knife Blades | SLIDE BLISTER CARD | 500 | 10 |

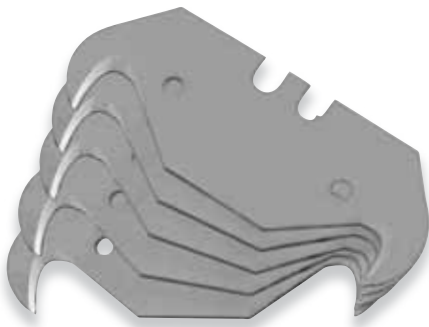

5-pc. Hook Utility Knife Blades

- SK5 Spring Steel Standard Duty (0.50 mm) Hook-Style Blades
- Universal Replacement Blades fit Most Utility Knives

| Item | Description | Packaging | Cs | In |
|------|---------------------------------|--------------------|-----|----|
| 6922 | 5-pc. Hook Utility Knife Blades | SLIDE BLISTER CARD | 500 | 10 |



100-pc. Utility Knife Blade Dispenser

- Compact and Convenient Storage Protects Blades
- Safely Dispenses Blades One at a Time
- Universal Replacement Blades fit Most Utility Knives
- 100-pc. Standard Duty (0.50mm) Utility Knife Blades

| Item | Description | Packaging | Cs | In |
|-------|---------------------------------------|--------------------|----|----|
| 82580 | 100-pc. Utility Knife Blade Dispenser | SLIDE BLISTER CARD | 48 | 6 |



7" Linoleum Knife

- Tempered Steel Hooked Blade
- Precision-Ground Cutting Edge
- Contoured Natural Hardwood Handle
- Cuts Linoleum, Carpet, Vinyl, and Other Sheet Materials

| Item | Description | Packaging | Cs | In |
|------|-------------------|-------------------------|----|----|
| 6925 | 7" Linoleum Knife | HALF SLIDE BLISTER CARD | 72 | 6 |



Glass Cutter

- Die Cast Zinc Construction
- Carbide Steel Cutting Wheel
- Three Snap-Off Channels: 1/8", 5/32", and 3/16"

| Item | Description | Packaging | Cs | In |
|------|--------------|--------------------|-----|----|
| 6927 | Glass Cutter | SLIDE BLISTER CARD | 144 | 12 |



Hobby Knife

- Rugged, Lightweight Aluminum Handle
- Non-Slip Knurled Grip Collar
- 4-Jaw Collet Locks Blade in Place
- Use for Model Making, Mat Cutting, and Trimming
- 5" Overall Length

- 1-pc. Aluminum Handle
- 1-pc. Safety Cap
- 2-pc. Blades
- 1-pc. Blade Storage Case

| Item | Description | Packaging | Cs | In |
|------|-------------|--------------|-----|----|
| 7502 | Hobby Knife | BLISTER CARD | 240 | 20 |



17-pc. Hobby Knife Set

- Surgically Sharp Spring Steel Razor Blades
- 4-Jaw Locking Mechanism Secures Blade Safely in Handle
- Aluminum Handles with Knurled Grips for Precise Control
- Heavy Duty ABS Handle for Tougher Cutting Jobs and Carving
- Complete Hobby Project Knife Set for Model Making, Mat Cutting, and Carving

- 13-pc. Assorted Blades
- 1-pc. 4-1/2" Small Aluminum Knife Handle
- 1-pc. 4-1/2" Large Aluminum Knife Handle
- 1-pc. 4-1/2" ABS Knife Handle
- 1-pc. Snap-In Case with Magnetic Organizer

| Item | Description | Packaging | Cs | In |
|------|------------------------|--------------------|----|----|
| 7509 | 17-pc. Hobby Knife Set | SLIDE BLISTER CARD | 72 | 6 |



Retractable Safety Scraper

- Durable Chrome Plated Finish
 - Fully Retractable Blade
 - SK5 Spring Steel Scraper Blades
 - Removes Paint, Adhesive, and Labels from Windows, Mirrors, and Tile
- 1-pc. Retractable Safety Scraper
 - 5-pc. Scraper Blades

| Item | Description | Packaging | Cs | In |
|------|----------------------------|--------------|-----|----|
| 6935 | Retractable Safety Scraper | BLISTER CARD | 144 | 12 |



Retractable Safety Scraper

- Lightweight and Durable ABS Housing
- Fully Retractable Blade
- SK5 Spring Steel Scraper Blades
- Removes Paint, Adhesive, and Labels from Windows, Mirrors, and Tile

| Item | Description | Packaging | Cs | In |
|------|----------------------------|--------------------|-----|----|
| 6938 | Retractable Safety Scraper | SLIDE BLISTER CARD | 288 | 12 |

10-pc. Safety Scraper Blades

- SK5 Spring Steel Construction
- Universal Replacement Blades for all Safety Scrapers

| Item | Description | Packaging | Cs | In |
|------|------------------------------|--------------------|-----|----|
| 6940 | 10-pc. Safety Scraper Blades | SLIDE BLISTER CARD | 500 | 10 |





Putty and Taping Knives

69271, 69274, 69275, 69277, 69278, 69279

- Full Tang, Double Riveted Construction
- Durable Contoured Hardwood Handle
- Coated Steel Blade for Easy Clean-up and to Resist Rust and Corrosion
- Light Gauge (.020") Flexible Blade for Better Control

69272, 69276

- Full Tang, Double Riveted Construction
- Durable Contoured Hardwood Handle
- Coated Steel Blade for Easy Clean-up and to Resist Rust and Corrosion
- Heavy Gauge (.040") Stiff Blade Applies More Pressure

69281

- Full Tang, Double Riveted Construction
- Durable Contoured Hardwood Handle
- Coated Steel Blade for Easy Clean-up and to Resist Rust and Corrosion
- 2-1/2" Deep-Groove Comb Cleans Paint and Debris from any Paint Brush
- Roller Cleaner Scrapes Paint from Roller Cover Surface to Speed Cleaning

| Item | Description | Packaging | Cs | In |
|-------|----------------------------|------------------|-----|----|
| 69271 | 1-1/4" Putty Knife (Flex) | BULK/COLOR LABEL | 144 | 12 |
| 69272 | 1-1/4" Putty Knife (Stiff) | BULK/COLOR LABEL | 144 | 12 |
| 69274 | 2" Putty Knife (Flex) | BULK/COLOR LABEL | 144 | 12 |
| 69275 | 3" Putty Knife (Flex) | BULK/COLOR LABEL | 144 | 12 |
| 69276 | 3" Putty Knife (Stiff) | BULK/COLOR LABEL | 144 | 12 |
| 69277 | 4" Taping Knife (Flex) | BULK/COLOR LABEL | 144 | 12 |
| 69278 | 5" Taping Knife (Flex) | BULK/COLOR LABEL | 144 | 12 |
| 69279 | 6" Taping Knife (Flex) | BULK/COLOR LABEL | 144 | 12 |
| 69281 | Brush and Roller Cleaner | BULK/COLOR LABEL | 144 | 12 |



5-in-1 Painter's Tool

- Tempered High Carbon Steel Blade
- Polished, Lacquer-Coated Finish
- Full Tang Riveted Construction
- Five Tools in One: Paint Scraper, Putty Knife, Paint Can Opener, Crevice Cleaner, Roller Cleaner

| Item | Description | Packaging | Cs | In |
|------|-----------------------|-----------------------|-----|----|
| 6928 | 5-in-1 Painter's Tool | SEALED BLISTER - HALF | 144 | 12 |

5-pc. Foam Brush Set

- Super-Absorbent Foam Holds and Applies Material Evenly for a Smooth Finish
- Ideal Applicator for Stain and Polyurethane Finishes
- 4" Hardwood Handles
- 5-pc. Brush Set: 1", 1-1/2", 2", 2-1/2", 3"

| Item | Description | Packaging | Cs | In |
|------|----------------------|-------------------|-----|----|
| 6996 | 5-pc. Foam Brush Set | POLYBAG/HANG CARD | 288 | 24 |



5-pc. Paint Brush Set

- General Purpose Polyester Bristles for Use with Latex and Oil-Based Paints and Stains
- Use on Interior and Exterior Smooth to Semi-Rough Surfaces
- Comfortable Contoured Handles
- 5-pc. Brush Set: 1", 1-1/2", 2", 2-1/2", 3"

| Item | Description | Packaging | Cs | In |
|------|-----------------------|-------------------|----|----|
| 7002 | 5-pc. Paint Brush Set | POLYBAG/HANG CARD | 60 | 10 |



9" Caulking Gun

- Rugged All-Steel Construction
- Continuous Toothless Ratchet Advances Smoothly in Any Increment
- Quick-Release Button for Removal of Cartridge
- Accepts All Standard 9" Cartridges

| Item | Description | Packaging | Cs | In |
|------|-----------------|------------------|----|----|
| 7007 | 9" Caulking Gun | BULK/COLOR LABEL | 36 | 6 |





Eye Guard Goggles

- Lightweight and Durable Polycarbonate Lens
- Easily Fits over Prescription Eyewear
- Adjustable Elastic Headband
- Completely Vented to Prevent Fogging
- Provides Required Eye Protection for Many Hand and Power Tool Applications
- Meets or Exceeds ANSI Spec. Z87.1 Standards for Protective Eyewear

| Item | Description | Packaging | Cs | In |
|------|-------------------|-------------------|-----|----|
| 6975 | Eye Guard Goggles | POLYBAG/HANG CARD | 200 | 10 |



Dust Masks

- Moldable Nosepiece for Comfortable Custom Fit
- Low Profile Design for Use with Safety Glasses
- Allows Easy Breathing and Speech
- Filters Dust, Pollen, Pet Dander, and Other Non-Toxic Particles

6980

- AVAILABLE IN DISPLAY QUANTITIES ONLY

| Item | Description | Packaging | Cs | In |
|-------|---------------------|-----------------------|----|----|
| 6980 | 50-pc. Dust Masks | 50-PC. DISPLAY BOX | 24 | 1 |
| 6981 | 5-pc. Dust Masks | SEALED BLISTER - FULL | 72 | 12 |
| 96981 | 5-pc. Dust Mask Set | POLYBAG/HANG CARD | 72 | 12 |



Deluxe Knee Pads

- Tough Nylon Construction
- Hard Caps Protect Knees from Rough Surfaces
- Soft Contoured Padded Lining
- Comfortable Extra Wide Adjustable Elastic Straps
- Contractor-Grade
- One Size Fits All

| Item | Description | Packaging | Cs | In |
|------|------------------|-------------------|----|----|
| 7023 | Deluxe Knee Pads | POLYBAG/HANG CARD | 36 | 6 |



Ear Muff Hearing Protection

- Adjustable Headstrap for Custom Fit
- Large Comfortable Cushioned Ear Cups
- Lightweight, High-Impact ABS Construction
- Reduces Harmful Noise while Operating Lawn Mowers and String Trimmers, Circular Saws, and Other Power Tools

| Item | Description | Packaging | Cs | In |
|------|-----------------------------|-------------------|----|----|
| 6984 | Ear Muff Hearing Protection | POLYBAG/HANG CARD | 72 | 6 |



Dust Filter Mask

- Flexible Padded Seal for Comfortable Custom Fit
- Wide Adjustable Elastic Headband
- Low Profile Design for Use with Safety Glasses
- Allows Easy Breathing and Speech
- Filters Dust, Pollen, Pet Dander, and Other Non-Toxic Particles

| Item | Description | Packaging | Cs | In |
|------|------------------|--------------------|-----|----|
| 6982 | Dust Filter Mask | SLIDE BLISTER CARD | 144 | 12 |



High-Visibility Safety Tape

- Weather-Resistant
- Non-Adhesive
- Tape Size: 3" x 300'

| Item | Description | Packaging | Cs | In |
|------|-----------------------------|-------------------------|----|----|
| 7402 | High-Visibility Safety Tape | SHRINK WRAP/COLOR LABEL | 24 | 4 |



100' Chalk Line Reel with Chalk

- Self-Chalking Cast Zinc Housing
- Housing Doubles as a Plumb Bob
- 1-1/2" Fold-Away Reel Crank Handle
- 100' Lightweight Braided Line
- Includes Chalk Refill Bottle

| Item | Description | Packaging | Cs | In |
|------|---------------------------------|-----------------------|----|----|
| 7003 | 100' Chalk Line Reel with Chalk | SEALED BLISTER - FULL | 24 | 6 |



100' Chalk Line Reel

- Self-Chalking Cast Zinc Housing
- Housing Doubles as a Plumb Bob
- 1-1/2" Fold-Away Reel Crank Handle
- 100' Lightweight Braided Line

| Item | Description | Packaging | Cs | In |
|------|----------------------|--------------------|----|----|
| 7005 | 100' Chalk Line Reel | SLIDE BLISTER CARD | 96 | 12 |

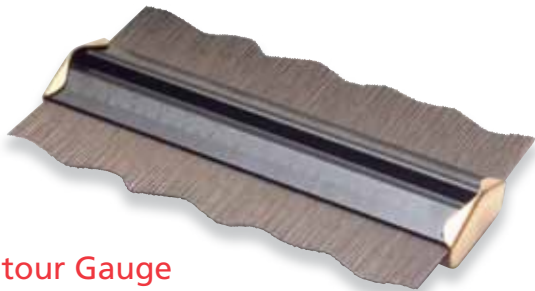

Contour Gauge

- Rugged Metal Body
- Corrosion-Resistant Stainless Steel Pins
- Die Stamped Inch Scale (1/16" Graduations) and Metric Scale (Millimeter Graduations)
- Quickly Duplicates Difficult or Intricate Shapes and Patterns

| Item | Description | Packaging | Cs | In |
|------|---------------|--------------------|----|----|
| 7015 | Contour Gauge | SLIDE BLISTER CARD | 36 | 6 |

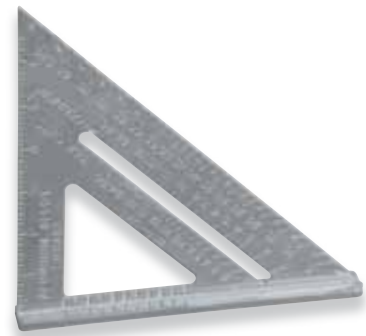

7" Aluminum Quick Square

- Rugged, Lightweight Aluminum
- Angle, Hip/Valley, Top/Common Cut, and Inch Markings
- Broad Foot Aligns Square and Slides Along Board Edge
- All-in-One Rafter Angle Square, Tri-Square, and Protractor
- Includes Rafter Layout and Reference Guide

| Item | Description | Packaging | Cs | In |
|------|--------------------------|--------------------|----|----|
| 7135 | 7" Aluminum Quick Square | SLIDE BLISTER CARD | 96 | 12 |



8" x 12" Carpenter's Square

- Durable Steel Construction
- Black Baked Enamel Finish
- High Contrast White Markings
- 8" (1") x 12" (1-1/2")

| Item | Description | Packaging | Cs | In |
|------|-----------------------------|-----------|-----|----|
| 7140 | 8" x 12" Carpenter's Square | HANG CARD | 120 | 40 |



12" Combination Square

- Die Cast Aluminum Head with Built-in Level Vial
- 12" Steel Scale with 1/16" Graduations
- Multi-Purpose Layout Tool: Framing Square, Tri-Square, Straight Edge, Level, and Depth Gauge

| Item | Description | Packaging | Cs | In |
|------|------------------------|--------------|----|----|
| 7145 | 12" Combination Square | BLISTER CARD | 72 | 12 |



5-pc. Mini Level Set

- 3-Vial Magnetic Torpedo Level Attracts to Pipes and Metal Studs and Measures Plumb, Level, and 45-degrees
- 2-in-1 Pocket Level/Screwdriver Includes 1/4" Flat and #2 Phillips Bits
- Multi-Purpose Bull's Eye Level and "T"-Level for General Purpose Applications
- Line Level with Offset Hooks Attaches Securely to Mason's Line
- Compact Layout Tools for a Wide Range of Projects: Finish Carpentry, Plumbing, Landscaping, Workshop, and Assembly
- 1-pc. 9" Torpedo Level
- 1-pc. Pen Level/Screwdriver
- 1-pc. Bull's Eye Level
- 1-pc. "T"-Level
- 1-pc. Line Level

| Item | Description | Packaging | Cs | In |
|-------|----------------------|--------------------|----|----|
| 71142 | 5-pc. Mini Level Set | SLIDE BLISTER CARD | 48 | 2 |



18" Triple Vial Level

- One-Piece Cast I-Beam Construction
- 3-Vial Design Measures Level, Plumb, and 45°
- Easy Read Dual Inch/Metric Measuring Scale

| Item | Description | Packaging | Cs | In |
|-------|-----------------------|------------------|----|----|
| 71141 | 18" Triple Vial Level | BULK/COLOR LABEL | 24 | 2 |



9" 3-Vial Magnetic Torpedo Level

- Lightweight, Compact, All-Purpose Level
- Three Vials Measure Plumb, Level, and 45°
- Magnetic Base Attracts to Ferrous Metal Pipes, Studs, Posts and Drop Ceiling Beams

| Item | Description | Packaging | Cs | In |
|-------|----------------------------------|------------------|-----|----|
| 97108 | 9" 3-Vial Magnetic Torpedo Level | BULK/COLOR LABEL | 144 | 12 |



6" Vernier Caliper

- Chrome Plated Steel Construction
- Reads 0-6" in 1/128" Graduations and 0-155mm in .05mm Graduations
- Jaws Measure Inside and Outside Dimensions
- Includes Depth Gauge
- Thumb Screw Locks Reading in Place
- Rolling Adjustment for Precise Jaw Positioning

| Item | Description | Packaging | Cs | In |
|------|--------------------|--------------------|-----|----|
| 7159 | 6" Vernier Caliper | SLIDE BLISTER CARD | 144 | 12 |



6" Dial Calipers

- Hardened, Satin Chrome Plated Steel
- Precision Ground Jaws for Accuracy
- Thumb Roll for Precise Jaw Positioning
- Slide Lock Holds Reading in Place
- Jaws Designed for Inside, Outside, and Thread Measurements
- Micro-Fine Black Graduations for Precise Readings
- Adjustable Dial Reads 0-6" in 0.001" Graduations
- Complete with Plastic Storage Case

| Item | Description | Packaging | Cs | In |
|------|------------------|-----------|----|----|
| 7165 | 6" Dial Calipers | BULK/UPC | 50 | 1 |



Outside Micrometer

- Malleable Steel "C" Frame with Heat-Insulated Grip Plates
- Precision-Ground Hardened Steel Spindle
- Thumb Switch Locks Reading in Place
- Micrometer Reads 0-1" in 0.0001" Graduations
- Ratchet Thimble Applies Correct Pressure for Accurate Readings
- Includes Zero-Adjusting Wrench

| Item | Description | Packaging | Cs | In |
|------|--------------------|-----------------------|----|----|
| 7168 | Outside Micrometer | SEALED BLISTER - FULL | 50 | 5 |



0-1" Dial Indicator

- Reads 0-1" in 0.001" Graduations
- 2" Diameter Dial Face with Inset Revolution Counter
- Smooth Jeweled Movement for Precise Readings
- Hardened Steel Contact Point
- Universal Mount
- Can be Used with TEKTON® 7172 Magnetic Base

| Item | Description | Packaging | Cs | In |
|------|---------------------|-----------------------|----|----|
| 7169 | 0-1" Dial Indicator | SEALED BLISTER - FULL | 50 | 10 |



Magnetic Base For Dial Indicator

- 3-Lb. Weighted, Cast Steel Base with Built-in Magnet
- On/Off Switch Releases Magnet
- Fully Adjustable Two-Arm Design
- Precision-Adjustment Knob for Fine Positioning
- Accepts Many Dial Indicator Mounts
- Can be Used with TEKTON® 7169 Dial Indicator

| Item | Description | Packaging | Cs | In |
|------|----------------------------------|-----------------------|----|----|
| 7172 | Magnetic Base For Dial Indicator | WHITE BOX/COLOR LABEL | 20 | 1 |



Tape Measures

- Rugged, Impact-Resistant ABS Housing with Non-Slip Cushioned Grip
- Posi-Lock Sliding Thumb Switch Locks Tape Securely in Position
- One-Touch Quick-Stop Button Pauses Tape at any Position
- Triple-Rivet Sliding End Hook for Accurate Inside and Outside Measurements
- Shock-Absorbing Bumper Guard Cushions Rewinding Tape Blade
- Durable Coated Blade Resists Corrosion
- Rapid Read™ Black-on-Yellow Blade Features:
 - Fractional Readout Every 1/8"
 - Stud Markings in Red Every 16"
 - 1/16" Graduations Throughout

| Item # | Size |
|--------|------------|
| 71951 | 12' x 1/2" |
| 71952 | 16' x 3/4" |
| 71953 | 25' x 1" |
| 71954 | 30' x 1" |
| 71955 | 33' x 1" |

| Item | Description | Packaging | Cs | In |
|-------|-------------------------|-----------|----|----|
| 71951 | 12' x 1/2" Tape Measure | HANG CARD | 72 | 6 |
| 71952 | 16' x 3/4" Tape Measure | HANG CARD | 72 | 6 |
| 71953 | 25' x 1" Tape Measure | HANG CARD | 36 | 4 |
| 71954 | 30' x 1" Tape Measure | HANG CARD | 36 | 4 |
| 71955 | 33' x 1" Tape Measure | HANG CARD | 36 | 4 |



12' x 1/2" Tape Measure

- Rugged, Impact-Resistant ABS Housing
- Triple-Rivet Sliding End Hook for Accurate Inside/Outside Measurements
- Easy-Read, Black-on-Yellow Tape with Corrosion-Resistant Coating
- 1/32" Graduations for First Foot, 1/16" Graduations Throughout
- Stud Markings in Red Every 16"

| Item | Description | Packaging | Cs | In |
|------|-------------------------|-----------|----|----|
| 7197 | 12' x 1/2" Tape Measure | HANG CARD | 72 | 12 |



25' x 1" Tape Measure

- Rugged, Impact-Resistant ABS Housing
- Durable Coated Blade Resists Corrosion
- Sliding Thumb Switch Locks Tape in Position
- 7' Blade Standout Length
- Triple-Rivet Sliding End Hook for Accurate Inside and Outside Measurements
- Rapid Read™ Black-on-Yellow Blade Features:
 - Fractional Readout Every 1/8"
 - Stud Markings in Red Every 16"
 - 1/32" Graduations (first foot), 1/16" Graduations Throughout

| Item | Description | Packaging | Cs | In |
|------|-----------------------|-----------|----|----|
| 7214 | 25' x 1" Tape Measure | HANG CARD | 36 | 6 |

12' x 1/2" Tape Measure

- Rugged, Impact-Resistant ABS Housing
- Triple-Rivet Sliding End Hook for Accurate Inside/Outside Measurements
- Easy-Read, Black-on-Yellow Tape with Corrosion-Resistant Coating
- 1/32" Graduations for First Foot, 1/16" Graduations Throughout
- Stud Markings in Red Every 16"

• AVAILABLE IN DISPLAY QUANTITIES ONLY

| Item | Description | Packaging | Cs | In |
|------|-------------------------|--------------------|----|----|
| 7198 | 12' x 1/2" Tape Measure | 12-PC. DISPLAY BOX | 6 | 1 |



25' x 1" Tape Measure

- Rugged, Impact-Resistant ABS Housing
- Durable Coated Blade Resists Corrosion
- Sliding Thumb Switch Locks Tape in Position
- 7' Blade Standout Length
- Triple-Rivet Sliding End Hook for Accurate Inside and Outside Measurements
- Rapid Read™ Black-on-Yellow Blade Features:
 - Fractional Readout Every 1/8"
 - Stud Markings in Red Every 16"
 - 1/32" Graduations (first foot), 1/16" Graduations Throughout

• AVAILABLE IN DISPLAY QUANTITIES ONLY

| Item | Description | Packaging | Cs | In |
|------|-----------------------|--------------------|----|----|
| 7213 | 25' x 1" Tape Measure | 12-PC. DISPLAY BOX | 3 | 1 |



Fiberglass Tape Measures

- Rugged, Impact-Resistant ABS Reel Housing with Carry Handle
- Fiberglass-Core Tape with Durable Vinyl Coating
- Moisture Resistant Tape
- Inch and Metric Graduations
- Steel Crank Handle Locks Conveniently Out of Way
- Use for Landscaping, Building, Surveying, and Many Other Commercial and Industrial Applications

| Item | Description | Packaging | Cs | In |
|------|------------------------------|-----------|----|----|
| 7225 | 50' Fiberglass Tape Measure | TIE CARD | 24 | 6 |
| 7230 | 100' Fiberglass Tape Measure | TIE CARD | 24 | 4 |
| 7235 | 165' Fiberglass Tape Measure | TIE CARD | 24 | 4 |
| 7240 | 300' Fiberglass Tape Measure | TIE CARD | 12 | 3 |



6' Folding Ruler

- Wood Ruler with High-Contrast Black-on-Yellow Markings
- Compact 9" Folded Size
- Brass Plated Folding Joints Lock Ruler into Position at 180°

| Item | Description | Packaging | Cs | In |
|------|------------------|--------------|-----|----|
| 7245 | 6' Folding Ruler | COLOR SLEEVE | 240 | 12 |





7-pc. Hex Shank HSS Drill Bit Set

- Hardened M2 High Speed Steel Twist Drill Bits
 - Precision Roll-Forged Flutes
 - Universal Fit 1/4" Chrome Vanadium Steel Hex Shanks
 - 118° Point Starts on Contact, Reduces Walking
 - Multi-Purpose Bits for Wood, Metal and Plastic
- 7-pc. HSS Drill Bits (1/4" Hex Shank): 1/16", 5/64", 3/32", 7/64", 1/8", 5/32", 3/16"

| Item | Description | Packaging | Cs | In |
|------|-----------------------------------|-----------------------|----|----|
| 2934 | 7-pc. Hex Shank HSS Drill Bit Set | SEALED BLISTER - FULL | 72 | 6 |



5-pc. Hex Shank Titanium HSS Drill Bit Set

- Hardened M2 High Speed Steel Twist Drill Bits
 - Titanium-Nitride Coating Resists Heat for Increased High Speed Performance
 - Polished, Precision Roll-Forged Flutes
 - Universal Fit 1/4" Chrome Vanadium Steel Hex Shanks
 - 118° Point Starts on Contact, Reduces Walking
 - Multi-Purpose Bits for Wood, Metal and Plastic
- 5-pc. Titanium Drill Bits (1/4" Hex Shank): 1/16", 3/32", 1/8", 5/32", 3/16"

| Item | Description | Packaging | Cs | In |
|------|--|-----------------------|----|----|
| 2936 | 5-pc. Hex Shank Titanium HSS Drill Bit Set | SEALED BLISTER - FULL | 72 | 6 |



7-pc. Brad Point Drill Bit Set

- Hardened and Tempered, High-Carbon Steel Construction
 - Black Oxide Finish for Long, Dependable Life
 - Precision Machined Flutes
 - Polished Cutting Edges for Reduced Friction
 - 1/4" Reduced Shanks fit all Drills
 - Brad Point on Tip Holds Bit Straight while Drilling, Locking it on Course
 - Will not Wander, Splinter, or Mar Surface
 - Drills Smooth, Perfectly Round Holes Through Wood or Light-Gauge Metal
- 7-pc. Brad Point Drill Bits: 1/8", 3/16", 1/4", 5/16", 3/8", 7/16", 1/2"
• Complete with Plastic Index Case

| Item | Description | Packaging | Cs | In |
|------|--------------------------------|--------------------|----|----|
| 7288 | 7-pc. Brad Point Drill Bit Set | SLIDE BLISTER CARD | 72 | 6 |



22-pc. Countersink Drill Bit Set

- Hardened and Tempered M2 High Speed Steel
 - Single Twist Drill Bit Creates Tapered Hole and Countersink in One Action
 - Separately Adjustable and Removable 4-Flute Countersink and Stop Collar
- 7-pc. Drill Bits: 1/8", 9/64", 5/32", 11/64", 3/16", 13/64", 7/32"
• 7-pc. Countersinks
• 7-pc. Stop Collars
• 1-pc. Stop Collar Wrench
• Complete with Index Case

| Item | Description | Packaging | Cs | In |
|------|----------------------------------|-----------------------|----|----|
| 7289 | 22-pc. Countersink Drill Bit Set | SEALED BLISTER - FULL | 20 | 5 |



6-pc. Spade Bit Set

- High Carbon Steel Construction
- Grooved Spur Point for Exact Positioning and Quick Start
- Precision-Ground Edges Cut Faster and Cleaner
- Short Bit Length fits Between Joists, Studs, and into Other Tight Work Spaces
- Hex Shank Prevents Slipping in Drill Chuck
- Fits all Standard Drill Chucks
- Shank Length: 4"
- Shank Diameter: 1/4"
- 6-pc. Drill Bits: 3/8", 1/2", 5/8", 3/4", 7/8", 1"

| Item | Description | Packaging | Cs | In |
|------|---------------------|--------------------|----|----|
| 7290 | 6-pc. Spade Bit Set | SLIDE BLISTER CARD | 60 | 6 |



5-pc. Masonry Drill Bit Set

- High Carbon Steel Construction
- 135° Carbide Cutting Tip
- Universal Fit 1/4" Shank
- Cuts Brick, Concrete, and Ceramic Tile
- 5-pc. Drill Bits: 3/16", 1/4", 5/16", 3/8", 1/2"
- Complete with Storage Case

| Item | Description | Packaging | Cs | In |
|------|-----------------------------|--------------------|-----|----|
| 7293 | 5-pc. Masonry Drill Bit Set | SLIDE BLISTER CARD | 100 | 5 |



13-pc. Twist Drill Bit Set

- Carbon Steel Twist Drill Bits
- Precision Roll-Forged Flutes
- Use with all Power and Cordless Drills
- Multi-Purpose Bits for Wood and Plastic
- 13-pc. Drill Bits: 1/16", 5/64", 3/32", 7/64", 1/8", 9/64", 5/32", 11/64", 3/16", 13/64", 7/32", 15/64", 1/4"
- Complete with Index Case

| Item | Description | Packaging | Cs | In |
|------|----------------------------|--------------------|----|----|
| 7292 | 13-pc. Twist Drill Bit Set | SLIDE BLISTER CARD | 36 | 6 |



13-pc. High Speed Steel Drill Bit Set

- Hardened High Speed Steel Twist Drill Bits
- Precision Roll-Forged Flutes
- 118° Point Starts on Contact, Reduces Walking
- Multi-Purpose Bits for Wood, Metal and Plastic
- 13-pc. Drill Bit: 1/16", 5/64", 3/32", 7/64", 1/8", 9/64", 5/32", 11/64", 3/16", 13/64", 7/32", 15/64", 1/4"
- Complete with Index Case

| Item | Description | Packaging | Cs | In |
|------|---------------------------------------|--------------------|----|----|
| 7296 | 13-pc. High Speed Steel Drill Bit Set | SLIDE BLISTER CARD | 60 | 5 |



7295

7303

13-pc. High Speed Steel Drill Bit Sets

7295

- Hardened and Tempered M2 High Speed Steel Construction
- Polished Flutes Quickly Churn Debris Away From Work
- 135° Split Point Starts on Contact, Reduces Walking
- Multi-Purpose Bits for Wood, Plastic, and Metal

7303

- Hardened M2 High Speed Steel Twist Drill Bits
- Titanium-Nitride Coating Resists Heat for Increased High Speed Performance
- Polished, Precision Roll-Forged Flutes
- 135° Split Point Starts on Contact, Reduces Walking
- Multi-Purpose Bits for Wood, Metal and Plastic

- 13-pc. Drill Bit: 1/16", 5/64", 3/32", 7/64", 1/8", 9/64", 5/32", 11/64", 3/16", 13/64", 7/32", 15/64", 1/4"
- Complete with Metal Index Case

| Item | Description | Packaging | Cs | In |
|------|--|------------------|-----|----|
| 7295 | 13-pc. High Speed Steel Drill Bit Set | BULK/COLOR LABEL | 60 | 5 |
| 7303 | 13-pc. Titanium High Speed Steel Drill Bit Set | BULK/COLOR LABEL | 100 | 5 |



7302

7304

33-pc. High Speed Steel Drill Bit Sets

7302

- Hardened M2 High Speed Steel Twist Drill Bits
- Polished, Precision Roll-Forged Flutes
- 135° Split Point Starts on Contact, Reduces Walking
- 3/8" Reduced Shanks
- Multi-Purpose Bits for Wood, Metal and Plastic

7304

- Hardened M2 High Speed Steel Twist Drill Bits
- Titanium-Nitride Coating Resists Heat for Increased High Speed Performance
- Polished, Precision Roll-Forged Flutes
- 135° Split Point Starts on Contact, Reduces Walking
- 3/8" Reduced Shanks
- Multi-Purpose Bits for Wood, Metal and Plastic

- 33-pc. Drill Bits: 1/16" (2pc.), 5/64" (2pc.), 3/32", 7/64", 1/8" (2pc.), 9/64", 5/32", 11/64", 3/16", 13/64", 7/32", 15/64", 1/4", 17/64", 9/32", 19/64", 5/16", 21/64", 11/32", 23/64", 3/8", 25/64", 13/32", 27/64", 7/16", 29/64", 15/32", 31/64", 1/2"
- Complete with Metal Index Case

| Item | Description | Packaging | Cs | In |
|------|--|------------------|----|----|
| 7302 | 33-pc. High Speed Steel Drill Bit Set | BULK/COLOR LABEL | 12 | 1 |
| 7304 | 33-pc. Titanium High Speed Steel Drill Bit Set | BULK/COLOR LABEL | 12 | 6 |



29-pc. High Speed Steel Drill Bit Set

- Hardened M2 High Speed Steel Twist Drill Bits
- Precision Roll-Forged Flutes
- 118° Point Starts on Contact, Reduces Walking
- 3/8" Reduced Shanks
- Multi-Purpose Bits for Wood, Metal and Plastic

- 29-pc. Drill Bits: 1/16", 5/64", 3/32", 7/64", 1/8", 9/64", 5/32", 11/64", 3/16", 13/64", 7/32", 15/64", 1/4", 17/64", 9/32", 19/64", 5/16", 21/64", 11/32", 23/64", 3/8", 25/64", 13/32", 27/64", 7/16", 29/64", 15/32", 31/64", 1/2"
- Complete with Metal Index Case

| Item | Description | Packaging | Cs | In |
|------|---------------------------------------|-----------|----|----|
| 7297 | 29-pc. High Speed Steel Drill Bit Set | COLOR BOX | 12 | 6 |

45-pc. Tungsten Steel Tap and Die Sets

- Hardened Tungsten Alloy High Speed Steel
- Rust-Resistant Satin Finish
- Precision-Milled Threads Cut Raw Material or Repair Existing Threads

7560

- 1-pc. 1/4" "T" Tap Wrench
- 1-pc. 1/4" - 1" "T" Tap Wrench
- 1-pc. 2" (Dia.) "T" Die Stock
- 1-pc. 1-1/2" (Dia.) Die Stock Adapter
- 1-pc. Screwdriver
- 20-pc. Taps
- 20-pc. Split Dies
- Complete with Storage Case

Tap and Die Sizes:

- Coarse Threads (NC): 1/4 NC 20, 5/16 NC 18, 3/8 NC 16, 7/16 NC 14, 1/2 NC 13, 9/16 NC 12, 5/8 NC 11, 3/4 NC 10, 7/8 NC 9, 1 NC 8
- Fine Threads (NF): 1/4 NF 28, 5/16 NF 24, 3/8 NF 24, 7/16 NF 20, 1/2 NF 20, 9/16 NF 18, 5/8 NF 18, 3/4 NF 16, 7/8 NF 14, 1 NF 14

7561

- 1-pc. 1/4" "T" Tap Wrench
- 1-pc. 1/4" - 1" "T" Tap Wrench
- 1-pc. 2" (Dia.) "T" Die Stock
- 1-pc. 1-1/2" (Dia.) Die Stock Adapter
- 1-pc. Screwdriver
- 20-pc. Taps
- 20-pc. Split Dies
- Complete with Storage Case

Tap and Die Sizes:

- Coarse Threads (NC): 6 x 1.0, 8 x 1.25, 10 x 1.5, 12 x 1.75, 14 x 2.0, 16 x 2.0, 18 x 2.5, 20 x 2.5, 22 x 2.5, 24 x 3.0
- Fine Threads (NF): 6 x 0.75, 8 x 1.0, 10 x 1.25, 12 x 1.5, 14 x 1.5, 16 x 1.5, 18 x 1.5, 20 x 1.5, 22 x 1.5, 24 x 1.5



| Item | Description | Packaging | Cs | In |
|------|---------------------------------|-----------|----|----|
| 7560 | 45-pc. Tap and Die Set (SAE) | COLOR BOX | 3 | 1 |
| 7561 | 45-pc. Tap and Die Set (Metric) | COLOR BOX | 3 | 1 |

40-pc. Tap and Die Sets

- High Carbon Tool Steel Construction
- Precision-Milled Taps and Dies Cut Raw Material or Repair Existing Threads

7565

- 1-pc. Long Handle Adjustable Tap Wrench
- 1-pc. "T" Handle Tap Wrench
- 1-pc. Die Handle
- 1-pc. 1/8" Mini Flat Screwdriver
- 1-pc. Screw Pitch Gauge
- 1-pc. Plastic Organizer Case
- 17-pc. Taps
- 17-pc. Dies
- Tap and Die Sizes: 4 NS 40, 6 NC 32, 8 NC 32, 10 NC 24, 10 NF 32, 12 NC 24, 1/4 NC 20, 1/4 NF 28, 5/16 NC 18, 5/16 NF 24, 3/8 NC 16, 3/8 NF 24, 7/16 NC 14, 7/16 NF 20, 1/2 NC 13, 1/2 NF 20, 1/8 NPT 27

7570

- 1-pc. Long Handle Adjustable Tap Wrench
- 1-pc. "T" Handle Tap Wrench
- 1-pc. Die Handle
- 1-pc. 1/8" Mini Flat Screwdriver
- 1-pc. Screw Pitch Gauge
- 1-pc. Plastic Organizer Case
- 17-pc. Taps
- 17-pc. Dies
- Tap and Die Sizes: 3x0.5, 5x0.8, 7x1.0, 10x1.5, 3x0.6, 5x0.9, 7x0.75, 10x1.25, 4x0.7, 6x1.0, 8x1.25, 12x1.75, 4x0.75, 6x0.75, 8x1.0, 12x1.5, 1/8NPT27

| Item | Description | Packaging | Cs | In |
|------|---------------------------------|--------------------------|----|----|
| 7565 | 40-pc. Tap and Die Set (SAE) | PLASTIC TRAY/COLOR LABEL | 20 | 5 |
| 7570 | 40-pc. Tap and Die Set (Metric) | PLASTIC TRAY/COLOR LABEL | 20 | 5 |





9-pc. Ratchet Pipe Threader Kit

- Heat Treated High Carbon Steel Dies
- Precision-Milled Dies Cut New Material or Repair Existing Threads
- Reversible Ratchet-Drive Die Wrench
- 20" High-Torque Wrench Handle with Non-Slip Grip
- 5-pc. Pipe Thread Dies: 1/4", 3/8", 1/2", 3/4", 1" NPT
- 1-pc. Ratchet Die Wrench
- 2-pc. 20" Wrench Handle
- 1-pc. Carry Case

| Item | Description | Packaging | Cs | In |
|------|---------------------------------|-----------|----|----|
| 7574 | 9-pc. Ratchet Pipe Threader Kit | COLOR BOX | 2 | 1 |



5-pc. Screw Extractor Set

- Heat Treated High Carbon Steel Construction
- Corrosion-Resistant Finish
- Removes Broken Screws, Bolts, and Studs without Damaging Hole Threads
- 5-pc. Screw Extractors: 1/8" - 1/4", 1/4" - 5/16", 5/16" - 7/16", 7/16" - 9/16", 9/16" - 3/4"
- Complete with Storage Case

| Item | Description | Packaging | Cs | In |
|------|---------------------------|--------------|-----|----|
| 7576 | 5-pc. Screw Extractor Set | BLISTER CARD | 144 | 12 |



2-pc. Nut Splitter Set

- Forged and Hardened Chrome Molybdenum Steel Frames, Screws, and Chisels
- Large Screw Drives Generate More Cutting Power
- Cuts Rusted, Cross-Threaded or Damaged Nuts for Easy Removal without Damaging Bolt
- 1-pc. 5/16" - 5/8" (8-16mm) Nut Splitter, 9/16" Drive
- 1-pc. 5/8" - 7/8" (16-22mm) Nut Splitter, 3/4" Drive

| Item | Description | Packaging | Cs | In |
|------|------------------------|-----------------------|----|----|
| 7580 | 2-pc. Nut Splitter Set | SEALED BLISTER - FULL | 36 | 6 |

Claw Pick-Up Tools

7593

- 24" Flexible Spring Steel Shaft
- Spring-Loaded, 4-Prong Steel Claw
- Retrieves Small, Non-Ferrous Objects that Magnets Cannot

7597

- 36" Flexible Spring Steel Shaft
- Spring-Loaded, 4-Prong Steel Claw
- Retrieves Small, Non-Ferrous Objects that Magnets Cannot

| Item | Description | Packaging | Cs | In |
|------|-----------------------|-----------|-----|----|
| 7593 | 24" Claw Pick-Up Tool | HANG CARD | 100 | 10 |
| 7597 | 36" Claw Pick-Up Tool | HANG CARD | 100 | 10 |



Telescoping Magnetic Pick-Up Tool

- Retrieves Ferrous Metal Objects up to 3 lbs.
- Telescopes from 5-3/16" to 25"
- Chrome Plated Metal Shaft
- Gold Plated Pocket Clip, Cap, and Magnet Holder
- Black Enamel-Coated Housing

| Item | Description | Packaging | Cs | In |
|------|-----------------------------------|--------------------|-----|----|
| 7601 | Telescoping Magnetic Pick-Up Tool | SLIDE BLISTER CARD | 144 | 12 |



Pen Size Telescoping Pick-Up and Inspection Tools

7602

- Retrieves Ferrous Metal Objects up to 1/4 lb.
- Dual Ball Joint Positions Magnet at any Angle
- Telescopes from 6" to 19"
- Pen Size Tool with Pocket Clip
- Durable Chrome Plated Finish

7604

- 1-1/4" Diameter Mirror
- Telescopes from 6" to 19"
- Dual Ball Joint Positions Mirror at any Angle
- Pen Size Tool with Pocket Clip
- Durable Chrome Plated Finish

| Item | Description | Packaging | Cs | In |
|------|-----------------------------------|--------------------|-----|----|
| 7602 | Telescoping Magnetic Pick-Up Tool | SLIDE BLISTER CARD | 240 | 12 |
| 7604 | Telescopic Inspection Mirror | SLIDE BLISTER CARD | 240 | 12 |



Telescoping Pick-Up and Inspection Tools

7607

- Retrieves Ferrous Metal Objects up to 1/2 lb.
- Dual Ball Joint Positions Magnet at any Angle
- Telescopes from 11" to 17"
- Non-Slip Cushioned Handle Grip
- Durable Chrome Plated Finish

7608

- 2" Diameter Mirror
- Telescopes from 11" to 17"
- Dual Ball Joint Positions Mirror at any Angle
- Non-Slip Cushioned Handle Grip
- Durable Chrome Plated Finish

| Item | Description | Packaging | Cs | In |
|------|-----------------------------------|--------------------|----|----|
| 7607 | Telescoping Magnetic Pick-Up Tool | SLIDE BLISTER CARD | 72 | 12 |
| 7608 | Telescopic Inspection Mirror | SLIDE BLISTER CARD | 72 | 12 |





97603

7605
 • AVAILABLE IN DISPLAY
 QUANTITIES ONLY

8-lb. Telescoping Magnetic Pickup Tool

- Powerful Magnet Lifts up to 8 lbs.
- Chrome Plated Shaft Telescopes from 6-1/2" to 33"
- Removable Shielding Collar Prevents Magnetic Attraction to Non-Target Objects
- Non-Slip, Soft Finger Grip Handle

| Item | Description | Packaging | Cs | In |
|-------|--|--------------------|-----|----|
| 7605 | 8-lb. Telescoping Magnetic Pickup Tool | 12-PC. DISPLAY BOX | 12 | 1 |
| 97603 | 8-lb. Telescoping Magnetic Pickup Tool | BULK/COLOR LABEL | 300 | 12 |



24" Flexible Magnetic Pick-Up Tool

- Powerful Magnet Retrieves Ferrous Metal Objects up to 4 lbs.
- 20" Black Electroplated Flexible Steel Tube Shaft
- Flexible Shaft Holds any Position to Reach into Tight Spots
- Comfortable Mechanic's-Style Handle
- 24" Overall Length

| Item | Description | Packaging | Cs | In |
|------|------------------------------------|-------------------------|----|----|
| 7611 | 24" Flexible Magnetic Pick-Up Tool | HALF SLIDE BLISTER CARD | 48 | 6 |



19" Flexible Inspection Mirror

- Chrome Plated Steel Construction
- Black Matted Cushion Grip for a Comfortable Hold
- Flexible Steel Shaft Holds any Position for Steady Viewing in Hard-to-See Areas
- Precision Ground Lens Optics
- 19" Overall Length with 2-1/2" Diameter Mirror

| Item | Description | Packaging | Cs | In |
|------|--------------------------------|-----------|----|----|
| 7613 | 19" Flexible Inspection Mirror | HANG CARD | 96 | 12 |



2-pc. Telescoping Pick-Up and Inspection Tool Set

Inspection Tool:

- 2" Diameter Inspection Mirror
- Telescopes from 10" to 16"
- Dual Swivel Ball Joint Holds Mirror at any Position
- Non-Slip Cushion Grip
- Durable Chrome Plated Finish

Magnetic Pick-Up Tool:

- Retrieves Ferrous Metal Objects up to 2 lbs.
- Telescopes from 7" to 21"
- Comfortable Contoured Handle
- Durable Chrome Plated Finish

| Item | Description | Packaging | Cs | In |
|------|---|--------------------|----|----|
| 7619 | 2-pc. Telescoping Pick-Up and Inspection Tool Set | SLIDE BLISTER CARD | 72 | 6 |

50-lb. Magnetic Pick-Up Tools

7615

- Super-Strong Magnet Lifts up to 50 lbs.
- Retrieves Dropped Nails, Screws, Bolts, Tools, and Other Ferrous Metal Objects
- Comfortable Contoured Non-Slip Finger Grip Handle
- Extra Long 35" Shaft Quickly Sweeps Large Areas

7617

- Super-Strong Magnet Lifts up to 50 lbs.
- Retrieves Dropped Nails, Screws, Bolts, Tools, and Other Ferrous Metal Objects
- Comfortable Contoured Non-Slip Finger Grip Handle
- Extra Long 35" Shaft Quickly Sweeps Large Areas
- 37" Telescoping Shaft Compacts to 21" for Storage



| Item | Description | Packaging | Cs | In |
|------|--|------------------|----|----|
| 7615 | 50-lb. Magnetic Pick-Up Tool | BULK/COLOR LABEL | 12 | 4 |
| 7617 | 50-lb. Telescoping Magnetic Pick-Up Tool | BULK/COLOR LABEL | 12 | 4 |



16" Shop Dust Pan

- Extra-Wide 16" Mouth
- Heavy Gauge Steel Construction
- Hi-Visibility Cushioned Handle Grip
- Double-Riveted Tubular Steel Handle Lifts Heavy Loads
- Durable Electroplate Finish Resists Rust and Corrosion
- Heavy Duty For Shop, Garage, or Worksite

| Item | Description | Packaging | Cs | In |
|------|-------------------|------------------|----|----|
| 7676 | 16" Shop Dust Pan | BULK/COLOR LABEL | 24 | 12 |



1100-lb. Mover's Dolly

- Moves up to 1100 lbs.
- Rugged Hardwood Construction
- Heavy-Duty Non-Marring Swivel Casters Maneuver Easily in Tight Spaces
- Carpeted Rails Protect Items from Damage
- Outside Dimensions: 30.5" x 18.5" x 6"

| Item | Description | Packaging | Cs | In |
|------|------------------------|------------------|----|----|
| 5563 | 1100-lb. Mover's Dolly | BULK/COLOR LABEL | 2 | 1 |

Wire Wheels and Brushes

- Industrial Quality Crimped Steel Wire
- Galvanized Steel Housing
- Universal Fit 1/4" Steel Shank
- Removes Rust, Paint, and Scale to Prepare Metal Surfaces for Painting and Welding

| Item # | | | | | |
|--------|----|--------|-------------|--------------|--|
| 7999 | 2" | Coarse | Wheel Brush | Max. 4500RPM | |
| 8001 | 2" | Fine | Wheel Brush | Max. 4500RPM | |
| 8002 | 3" | Coarse | Wheel Brush | Max. 4500RPM | |
| 8003 | 3" | Fine | Wheel Brush | Max. 4500RPM | |
| 8004 | 4" | Coarse | Wheel Brush | Max. 4500RPM | |
| 8005 | 2" | Coarse | Cup Brush | Max. 4500RPM | |
| 8006 | 2" | Fine | Cup Brush | Max. 4500RPM | |
| 8007 | 3" | Coarse | Cup Brush | Max. 2500RPM | |
| 8008 | 3" | Fine | Cup Brush | Max. 2500RPM | |

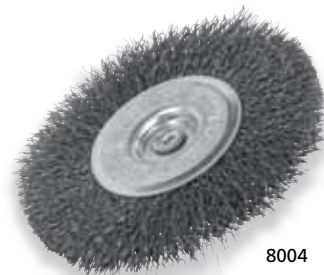
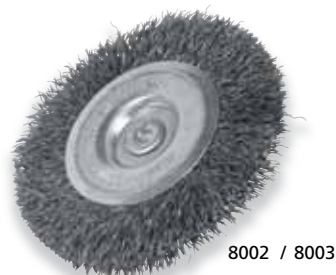

| Item | Description | Packaging | Cs | In |
|------|------------------------------|--------------------|----|----|
| 7999 | 2" Wire Wheel Brush - Coarse | SLIDE BLISTER CARD | 72 | 6 |
| 8001 | 2" Wire Wheel Brush - Fine | SLIDE BLISTER CARD | 72 | 6 |
| 8002 | 3" Wire Wheel Brush - Coarse | SLIDE BLISTER CARD | 48 | 6 |
| 8003 | 3" Wire Wheel Brush - Fine | SLIDE BLISTER CARD | 48 | 6 |
| 8004 | 4" Wire Wheel Brush - Coarse | SLIDE BLISTER CARD | 24 | 6 |
| 8005 | 2" Wire Cup Brush - Coarse | SLIDE BLISTER CARD | 72 | 6 |
| 8006 | 2" Wire Cup Brush - Fine | SLIDE BLISTER CARD | 72 | 6 |
| 8007 | 3" Wire Cup Brush - Coarse | SLIDE BLISTER CARD | 24 | 6 |
| 8008 | 3" Wire Cup Brush - Fine | SLIDE BLISTER CARD | 24 | 6 |

Wire Wheel and Brush Assortments

- Industrial Quality Crimped Steel Wire
- Galvanized Steel Housing
- Universal Fit 1/4" Steel Shank
- Removes Rust, Paint, and Scale to Prepare Metal Surfaces for Painting and Welding
- AVAILABLE IN DISPLAY QUANTITIES ONLY

- 8011
- 5-pc. 2" Wire Cup Brushes (Fine)
 - 5-pc. 2" Wire Cup Brushes (Coarse)
 - 2-pc. 1-1/2" Wire Wheel Brushes (Fine)
 - 2-pc. 1-1/2" Wire Wheel Brushes (Coarse)
 - 2-pc. 2" Wire Wheel Brushes (Fine)
 - 2-pc. 2" Wire Wheel Brushes (Coarse)
 - 3-pc. 2-1/2" Wire Wheel Brushes (Fine)
 - 3-pc. 2-1/2" Wire Wheel Brushes (Coarse)
 - 3-pc. 3" Wire Wheel Brushes (Fine)
 - 3-pc. 3" Wire Wheel Brushes (Coarse)
- 8012
- 5-pc. 3" Wire Cup Brushes (Coarse)
 - 5-pc. 3" Wire Cup Brushes (Fine)
 - 5-pc. 4" Wire Wheel Brushes (Coarse)
 - 5-pc. 4" Wire Wheel Brushes (Fine)



| Item | Description | Packaging | Cs | In |
|------|----------------------------|--------------------|----|----|
| 8011 | Wire Wheel and Cup Brushes | 30-PC. DISPLAY BOX | 10 | 1 |
| 8012 | Wire Wheel and Cup Brushes | 20-PC. DISPLAY BOX | 10 | 1 |



6" Wire Wheel

- Industrial Quality Crimped Steel Wire
- Universal Fit for 6" Bench Grinders with 1/2" Arbor
- Removes Rust, Paint, and Scale to Prepare Metal Surfaces for Painting and Welding
- 4500 RPM Max.
- 6" Diameter
- 1/2" Arbor

| Item | Description | Packaging | Cs | In |
|------|---------------|-----------------------|----|----|
| 5021 | 6" Wire Wheel | SEALED BLISTER - FULL | 40 | 5 |



Grinding Wheel Dresser

- Heavy-Gauge, All-Steel Construction
- Corrosion-Resistant Chrome Plated Finish
- Contoured Pistol Grip Handle
- Spurred Steel Wheels Remove Glazing and Material Fragments for a Fresh Grinding Surface

| Item | Description | Packaging | Cs | In |
|------|------------------------|-------------------------|----|----|
| 5014 | Grinding Wheel Dresser | HALF SLIDE BLISTER CARD | 48 | 8 |



6" Grinding Wheel

- Bonded Aluminum Oxide Abrasive
- Medium Grit
- Replacement Wheel for 6" Bench Grinders
- Maximum 4100 RPM
- 6" Diameter
- 3/4" Thick
- 1/2" Arbor

| Item | Description | Packaging | Cs | In |
|------|-------------------|------------------|----|----|
| 5016 | 6" Grinding Wheel | BULK/COLOR LABEL | 40 | 5 |

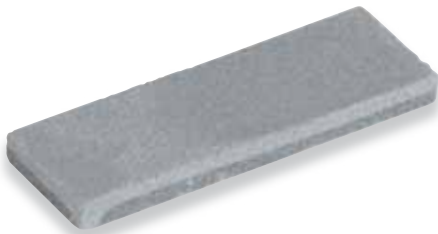

Pocket Sharpening Stone

- Bonded Aluminum Oxide Construction
- Dual Grade: Coarse and Fine Grit on Opposite Sides
- Sharpen and Hone Knives, Scissors and other Edged Tools
- Dimensions: 3" L x 1" W x 3/8" Thick

| Item | Description | Packaging | Cs | In |
|------|-------------------------|--------------------|----|----|
| 8014 | Pocket Sharpening Stone | SLIDE BLISTER CARD | 96 | 12 |

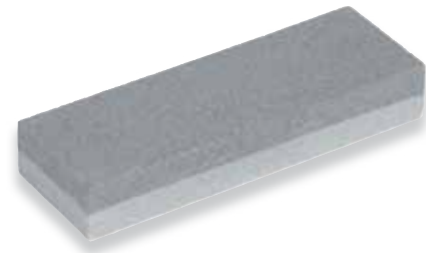

Sharpening Stone

- Bonded Aluminum Oxide Construction
- Dual Grade: Coarse and Fine Grit on Opposite Sides
- Sharpen and Hone Knives, Hatchets and other Edged Tools
- * Dimensions: 6" L x 2" W x 1" Thick

| Item | Description | Packaging | Cs | In |
|------|------------------|--------------------|----|----|
| 8022 | Sharpening Stone | SLIDE BLISTER CARD | 36 | 4 |



5-pc. Mounted Stone Set

- Bonded Aluminum Oxide Abrasive
- 1/8" Arbor Fits Most Power Drills and Grinders
- 12,000 RPM Maximum
- 1-pc. Small Cone
- 1-pc. Large Cone
- 1-pc. Ball
- 1-pc. Cylinder
- 1-pc. Bullet

| Item | Description | Packaging | Cs | In |
|------|-------------------------|--------------------|----|----|
| 8030 | 5-pc. Mounted Stone Set | SLIDE BLISTER CARD | 72 | 12 |



5-pc. Mounted Stone Set

- Bonded Aluminum Oxide Abrasive
- 1/4" Arbor Fits Most Power Drills and Grinders
- 12,000 RPM Maximum
- 1-pc. Cone
- 1-pc. Tapered Cylinder
- 1-pc. Ball
- 1-pc. Wheel
- 1-pc. Bullet

| Item | Description | Packaging | Cs | In |
|------|-------------------------|--------------------|----|----|
| 8032 | 5-pc. Mounted Stone Set | SLIDE BLISTER CARD | 72 | 12 |



Multi-Purpose Assorted Grit Sandpaper

- General-Purpose Aluminum Oxide Abrasive
- Heavy Duty Backing Paper for Longer Life
- Use for Bare Wood and Metal, Painted Surfaces and Drywall Finishing
- Consistent Performance for Hand or Machine Sanding
- Sheet Size: 9" x 11"

- 7010**
- 3-pc. Coarse (60)
 - 5-pc. Medium (100)
 - 5-pc. Fine (150)
 - 2-pc. Very Fine (240)
- 7011**
- 6-pc. Coarse (60)
 - 12-pc. Medium (100)
 - 12-pc. Fine (150)
 - 10-pc. Very Fine (240)

| Item | Description | Packaging | Cs | In |
|------|---|-----------|----|----|
| 7010 | 15-pc. General-Purpose Sandpaper (Assorted) | COLOR BOX | 50 | 10 |
| 7011 | 40-pc. General-Purpose Sandpaper (Assorted) | COLOR BOX | 20 | 5 |



Mini Wire Brushes

- 7058**
- Use for Cleaning and Polishing Small Parts and Hard to Get Areas
 - 7-3/4" Durable Hardwood Handle
 - Brass Bristles Cleans Metal Parts without Marring Surface or Danger of Sparking

- 7059**
- Use for Cleaning and Polishing Small Parts and Hard to Get Areas
 - 7-3/4" Durable Hardwood Handle
 - Stainless Steel Bristles Attack Heavy Duty Scrubbing Jobs

| Item | Description | Packaging | Cs | In |
|------|---------------------------------|-----------|-----|----|
| 7058 | Brass Mini Wire Brush | BULK/UPC | 480 | 24 |
| 7059 | Stainless Steel Mini Wire Brush | BULK/UPC | 480 | 24 |



Long Handle Wire Brushes

- 7070**
- Rugged 13" Natural Hardwood Handle
 - Tempered Carbon Steel Bristles
 - 3 x 19 Wire Bristle Configuration
 - Removes Rust, Paint, and Dirt to Prepare Rough Surfaces for Paint and Other Finishes

- 7072**
- Rugged 13" Natural Hardwood Handle
 - Tempered Carbon Steel Bristles
 - 3 x 19 Wire Bristle Configuration
 - Galvanized Steel Scraper Loosens Tough Material
 - Removes Rust, Paint, and Dirt to Prepare Rough Surfaces for Paint and Other Finishes

| Item | Description | Packaging | Cs | In |
|------|-------------------------------------|------------------|-----|----|
| 7070 | Long Handle Wire Brush | BULK/COLOR LABEL | 120 | 12 |
| 7072 | Long Handle Wire Brush with Scraper | BULK/COLOR LABEL | 120 | 12 |



Shoe Handle Wire Brushes

- 7075**
- Rugged 10" Natural Hardwood Shoe Handle
 - Tempered Carbon Steel Bristles
 - 4 x 16 Wire Bristle Configuration
 - Removes Rust, Paint, and Dirt to Prepare Rough Surfaces for Paint and Other Finishes

- 7076**
- Rugged 10" Natural Hardwood Shoe Handle
 - Tempered Carbon Steel Bristles
 - 4 x 16 Wire Bristle Configuration
 - Galvanized Steel Scraper Loosens Tough Material
 - Removes Rust, Paint, and Dirt to Prepare Rough Surfaces for Paint and Other Finishes

| Item | Description | Packaging | Cs | In |
|------|-------------------------------------|------------------|-----|----|
| 7075 | Shoe Handle Wire Brush | BULK/COLOR LABEL | 120 | 12 |
| 7076 | Shoe Handle Wire Brush with Scraper | BULK/COLOR LABEL | 120 | 12 |



5-pc. Detail Brush Set

- Clean Hard-to-Reach Areas in Vehicle Interiors, on Exterior Panels, and Under the Hood
- Comfortable Contoured Handles
- Nylon Bristles Sweep out Dirt and Dust from Fine Contours along Dashboard, Instrument Panels, and Air Vents
- Brass Bristles Clean Metal Parts without Damaging Surface or Danger of Sparking
- Stainless Steel Bristles for Heavy Duty Scrubbing Jobs
- 1-pc. Nylon Wire Brush
- 1-pc. Brass Wire Brush
- 1-pc. Stainless Steel Wire Brush
- 1-pc. Nylon Parts Brush
- 1-pc. Nylon Fingernail Brush

| Item | Description | Packaging | Cs | In |
|------|------------------------|--------------------|----|----|
| 7063 | 5-pc. Detail Brush Set | SLIDE BLISTER CARD | 96 | 12 |



3-pc. Mini Wire Brush Set

- 7" Fingergrip Handles for Precise Control
- Nylon Bristles Clean Delicate Parts and Detail Vehicle Interiors
- Brass Bristles Clean Metal Parts without Damaging Surface or Danger of Sparking
- Stainless Steel Bristles for Heavy Duty Scrubbing Jobs
- 1-pc. Nylon Wire Brush
- 1-pc. Brass Wire Brush
- 1-pc. Stainless Steel Wire Brush

| Item | Description | Packaging | Cs | In |
|------|---------------------------|--------------------|-----|----|
| 7064 | 3-pc. Mini Wire Brush Set | SLIDE BLISTER CARD | 120 | 6 |

3-pc. Wire Brush Set

- Comfortable Contoured Fingergrip Handles
- 9" Overall Length
- Nylon Bristles Clean Delicate Parts and Detail Vehicle Interiors
- Brass Bristles Clean Metal Parts without Damaging Surface or Danger of Sparking
- Stainless Steel Bristles for Heavy Duty Scrubbing Jobs
- 1-pc. Nylon Bristle Brush
- 1-pc. Brass Bristle Brush
- 1-pc. Stainless Steel Bristle Brush

| Item | Description | Packaging | Cs | In |
|------|----------------------|--------------------|----|----|
| 7068 | 3-pc. Wire Brush Set | SLIDE BLISTER CARD | 36 | 6 |



Long Handle Wire Brush

- Heavy-Duty 13" Poly Fingergrip Handle
- Tempered Carbon Steel Bristles
- 3 x 19 Wire Bristle Configuration
- Galvanized Steel Scraper Loosens Tough Material
- Removes Rust, Paint, and Dirt to Prepare Rough Surfaces for Paint and Other Finishes

| Item | Description | Packaging | Cs | In |
|------|------------------------|------------------|-----|----|
| 7073 | Long Handle Wire Brush | BULK/COLOR LABEL | 120 | 12 |



Shoe Handle Wire Brush

- Heavy-Duty 9" Poly Shoe Handle
- Tempered Carbon Steel Bristles
- 4 x 16 Wire Bristle Configuration
- Galvanized Steel Scraper Loosens Tough Material
- Removes Rust, Paint, and Dirt to Prepare Rough Surfaces for Paint and Other Finishes

| Item | Description | Packaging | Cs | In |
|------|------------------------|------------------|-----|----|
| 7074 | Shoe Handle Wire Brush | BULK/COLOR LABEL | 120 | 12 |



100-pc. Home Project Tool Set

- Complete Assortment of Essential Household Project and Repair Tools
- Forged and Hardened Steel Construction
- Precision-Machined and Assembled
- 1-pc. 12-oz. Claw Hammer
- 2-pc. 4" Screwdrivers: 1/4" Flat, #2 Phillips
- 5-pc. Precision Screwdrivers
- 1-pc. 6" Adjustable Wrench
- 1-pc. 6-1/2" Long Nose Pliers
- 1-pc. 6" Slip Joint Pliers
- 1-pc. Retractable Utility Knife (with Blade)
- 1-pc. 8" Stainless Steel Scissors
- 1-pc. 10' x 1/2" Locking Tape Measure
- 85-pc. Fastener/Picture Hanging Kit
- 1-pc. Storage Case

| Item | Description | Packaging | Cs | In |
|------|-------------------------------|-----------|----|----|
| 1848 | 100-pc. Home Project Tool Set | COLOR BOX | 12 | 1 |



8-pc. Home Project Tool Set

- Basic Assortment of Everyday Essential Home Project Tools
- Rugged Forged Heat Treated Steel Construction
- Non-Slip Comfort Grip Handles
- 1-pc. Snap-Off Utility Knife
- 2-pc. Screwdrivers: Flat 6mm x 100mm, Phillips #2 x 100mm
- 2-pc. Precision Screwdrivers: Flat 3mm x 50mm, Phillips #1 x 50mm
- 1-pc. 8" Adjustable Wrench
- 1-pc. 6" Linesman Pliers
- 1-pc. 10' Tape Measure

| Item | Description | Packaging | Cs | In |
|------|-----------------------------|-----------------------|----|----|
| 1853 | 8-pc. Home Project Tool Set | SEALED BLISTER - FULL | 24 | 6 |



4-pc. Home Project Tool Set

- Compact Assortment of Everyday Essential Home Project Tools
- Rugged Forged Heat Treated Steel Construction
- Non-Slip Comfort Grip Handles
- 1-pc. 6" Diagonal Cutting Pliers
- 1-pc. 6" Linesman Pliers
- 1-pc. 8oz. Stubby Claw Hammer
- 1-pc. 8" Adjustable Wrench

| Item | Description | Packaging | Cs | In |
|------|-----------------------------|-----------------------|----|----|
| 1851 | 4-pc. Home Project Tool Set | SEALED BLISTER - FULL | 12 | 2 |



14-pc. Home Project Tool Set

- Complete Assortment of Everyday Essential Home Project Tools
- Rugged Forged Heat Treated Steel Construction
- Non-Slip Comfort Grip Handles
- 1-pc. 6" Adjustable Wrench
- 1-pc. 6" Long Nose Pliers
- 1-pc. 16' x 3/4" Tape Measure
- 6-pc. Precision Screwdriver Set
- 1-pc. Utility Knife
- 1-pc. Replacement Blade Kit
- 1-pc. Stainless Steel Scissors
- 1-pc. Torpedo Level
- 1-pc. 16oz. Claw Hammer

| Item | Description | Packaging | Cs | In |
|------|------------------------------|-----------------------|----|----|
| 1855 | 14-pc. Home Project Tool Set | SEALED BLISTER - FULL | 12 | 1 |



110-pc. Auto Emergency Tool Kit

- All-in-One Assortment of Roadside Essentials to Keep You Safe and Get You Moving Again
- Store in Vehicle, RV, Boat, or Pack with Camping and Hunting Gear
- Impact-Resistant Flashlight with Bright Krypton Bulb
- FDA-Standard First-Aid Kit with Professional-Quality Bandage Strips for Cuts and Scrapes
- 8', 200A, 10-Gauge Heavy Duty Battery Booster Cables
- Siphon Pump Transfers Fuel from One Vehicle to Another Quickly and Safely
- 100 PSI Pocket Clip Tire Gauge
- 12-in-1 Pocket Tool in Compact Folding Case
- 1-pc. 8', 200A, 10-Gauge Battery Booster Cables
- 1-pc. "D"-Cell Flashlight
- 1-pc. Siphon Pump
- 1-pc. Pencil Tire Gauge
- 1-pair Disposable Cotton Gloves
- 1-pc. 12-in-1 Multi-Purpose Pocket Tool
- 1-pc. 6" Slip Joint Pliers
- 1-pc. 8" Adjustable Wrench
- 2-pc. Screwdrivers: 1/4" Flat x 4", #2 Phillips x 4"
- 9-pc. Auto Fuses (10-30 Amp)
- 10-pc. First Aid Kit
- 80-pc. Assorted Cable Ties
- 1-pc. Storage Case

| Item | Description | Packaging | Cs | In |
|------|---------------------------------|--------------|----|----|
| 1843 | 110-pc. Auto Emergency Tool Kit | COLOR SLEEVE | 4 | 1 |

9-LED Mini Flashlight

- Ultra Bright 9-LED Light Head
- Rugged Aluminum Housing
- Knurled Handle for Better Grip
- Compact Pocket Size
- Uses 3 "AAA" Batteries (Included)

• AVAILABLE IN DISPLAY QUANTITIES ONLY

| Item | Description | Packaging | Cs | In |
|------|-----------------------|--------------------|----|----|
| 7479 | 9-LED Mini Flashlight | 12-PC. DISPLAY BOX | 4 | 1 |



Compact Utility Tool Pouch

- All-Purpose Compact Utility Tool Pouch
- Rugged, Weather-Resistant Woven Nylon Stands up to Harsh Worksite Environments
- 50% Lighter than Leather
- Comfortable Padded Back
- Fits up to 2" Wide Belt
- Includes Large Main Pocket, Two Side Pockets, Nail Pouch, Hammer Loop, and More

| Item | Description | Packaging | Cs | In |
|------|----------------------------|-----------|----|----|
| 7028 | Compact Utility Tool Pouch | TIE CARD | 24 | 2 |



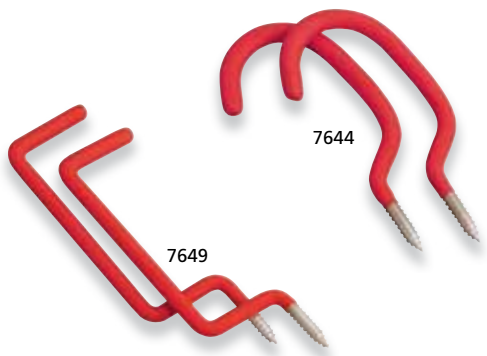
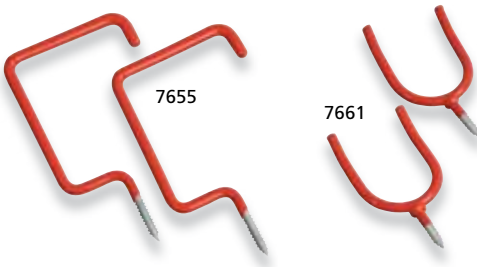
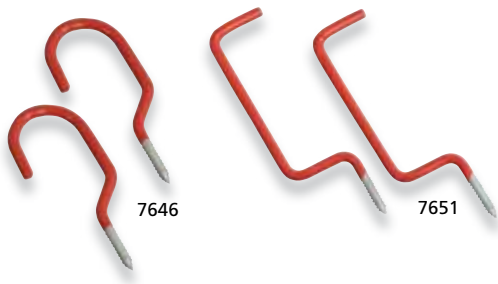

Utility Storage Hooks

- 7646**
- Galvanized Steel Construction
 - Soft Non-Marring, Non-Slip Coated Finish
 - Simple and Easy Installation
 - Use for Ceiling Storage of Bicycles, Lawn Furniture, and Garden Hoses
 - 60 lb. Capacity (per Hook)
 - Requires 3/16" dia. Pilot Hole

- 7651**
- Galvanized Steel Construction
 - Soft Non-Marring, Non-Slip Coated Finish
 - Simple and Easy Installation
 - Use for Wall Storage of Ladders, Garden Hoses, and Recreational Equipment
 - 20 lb. Capacity (per Hook)
 - Requires 5/32" dia. Pilot Hole

- 7655**
- Galvanized Steel Construction
 - Soft Non-Marring, Non-Slip Coated Finish
 - Simple and Easy Installation
 - Use for Ceiling Storage of Ladders, Garden Hoses, and Recreational Equipment
 - 25 lb. Capacity (per Hook)
 - Requires 5/32" dia. Pilot Hole

- 7661**
- Galvanized Steel Construction
 - Soft Non-Marring, Non-Slip Coated Finish
 - Simple and Easy Installation
 - Use for Wall Storage of Long Handled Tools Including Shovels, Brooms, and Rakes
 - 15 lb. Capacity (per Hook)
 - Requires 1/8" dia. Pilot Hole

| Item | Description | Packaging | Cs | In |
|------|--------------------|--------------------|----|----|
| 7646 | 2-pc. Bike Hooks | SLIDE BLISTER CARD | 96 | 12 |
| 7651 | 2-pc. Ladder Hooks | SLIDE BLISTER CARD | 96 | 12 |
| 7655 | 2-pc. Ladder Hooks | SLIDE BLISTER CARD | 96 | 12 |
| 7661 | 2-pc. Tool Hooks | SLIDE BLISTER CARD | 96 | 12 |

Heavy Duty Utility Storage Hooks

- 7644**
- Heavy Duty Galvanized Steel Construction
 - Soft Non-Marring, Non-Slip Coated Finish
 - Simple and Easy Installation
 - Use for Ceiling Storage of Bicycles, Lawn Furniture, and Garden Hoses
 - 100 lb. Capacity (per Hook)
 - Requires 5/16" dia. Pilot Hole

- 7649**
- Heavy Duty Galvanized Steel Construction
 - Soft Non-Marring, Non-Slip Coated Finish
 - Simple and Easy Installation
 - Use for Wall Storage of Ladders, Garden Hoses, and Recreational Equipment
 - 50 lb. Capacity (per Hook)
 - Requires 5/16" dia. Pilot Hole

| Item | Description | Packaging | Cs | In |
|------|-------------------------------|--------------------|----|----|
| 7644 | 2-pc. Heavy Duty Bike Hooks | SLIDE BLISTER CARD | 36 | 4 |
| 7649 | 2-pc. Heavy Duty Ladder Hooks | SLIDE BLISTER CARD | 36 | 4 |

50-pc. O-Ring Assortment

- General Purpose O-Rings Seal Air, Plumbing, and Other Connections Against Leaks
- BUNA-N Material is Oil Proof and Passes ASTM Oil #1 and #3 Laboratory Tests

- 8-pc. 1/4" x 3/8"
- 8-pc. 3/8" x 1/2"
- 5-pc. 3/8" x 9/16"
- 3-pc. 7/16" x 5/8"
- 3-pc. 1/2" x 11/16"
- 3-pc. 9/16" x 3/4"
- 5-pc. 5/8" x 3/4"
- 3-pc. 5/8" x 13/16"
- 3-pc. 3/4" x 15/16"
- 3-pc. 3/4" x 1"
- 3-pc. 13/16" x 1-1/16"
- 3-pc. 11/16" x 7/8"



144-pc. Cotter Pin and Puller Set

- General Purpose Assortment of Common Cotter Pin Sizes
- Steel Construction with Galvanized Finish
- Includes Installer/Puller Tool

- 40-pc. 1/16" x 3/4"
- 40-pc. 3/32" x 3/4"
- 40-pc. 3/32" x 1"
- 12-pc. 1/8" x 1"
- 12-pc. 1/8" x 1-1/4"
- Complete with Installer/Puller Tool

| Item | Description | Packaging | Cs | In |
|------|-----------------------------------|-------------------|-----|----|
| 7685 | 144-pc. Cotter Pin and Puller Set | POLYBAG/HANG CARD | 100 | 10 |

| Item | Description | Packaging | Cs | In |
|------|--------------------------|--------------------|----|----|
| 7712 | 50-pc. O-Ring Assortment | SLIDE BLISTER CARD | 72 | 12 |

Laminated Steel Padlocks

- Case Hardened Steel Shackle Resists Sawing and Cutting
- Weather-Resistant, Chrome Plated Laminated Steel Body
- Solid Brass Cylinder and 4-Pin Tumbler
- Cushioned Bumper will not Scratch Surfaces
- Includes 2-pc. Key Set

| Item # | Body Width | Shackle Clearance (H) | Shackle Clearance (W) |
|--------|---------------|-----------------------|-----------------------|
| 7745 | 1-1/4" (32mm) | 11/16" (18mm) | 9/16" (15mm) |
| 7750 | 1-1/2" (40mm) | 15/16" (24mm) | 3/4" (20mm) |
| 7755 | 1-3/4" (45mm) | 1" (25mm) | 13/16" (21mm) |
| 7765 | 2" (50mm) | 1-1/8" (29mm) | 15/16" (24mm) |



| Item | Description | Packaging | Cs | In |
|------|--------------------------------|--------------------|-----|----|
| 7745 | 1-1/4" Laminated Steel Padlock | SLIDE BLISTER CARD | 240 | 12 |
| 7750 | 1-1/2" Laminated Steel Padlock | SLIDE BLISTER CARD | 72 | 12 |
| 7755 | 1-3/4" Laminated Steel Padlock | SLIDE BLISTER CARD | 72 | 12 |
| 7765 | 2" Laminated Steel Padlock | SLIDE BLISTER CARD | 48 | 12 |



2-pc. 1-1/2" Laminated Steel Padlocks

- Case Hardened Steel Shackle Resists Sawing and Cutting
- Weather-Resistant, Chrome Plated Laminated Steel Body
- Solid Brass Cylinder and 4-Pin Tumbler
- Cushioned Bumper will not Scratch Surfaces
- Each Lock Includes 2-pc. Key Set
- Same Key Opens Both Locks

Dimensions:

- Body Width: 1-1/2" (40mm)
- Shackle Clearance: 15/16" (24mm) H x 3/4" (20mm) W

| Item | Description | Packaging | Cs | In |
|------|---------------------------------------|--------------------|----|----|
| 7751 | 2-pc. 1-1/2" Laminated Steel Padlocks | SLIDE BLISTER CARD | 36 | 6 |



4-pc. 1-1/2" Laminated Steel Padlocks

- Case Hardened Steel Shackle Resists Sawing and Cutting
- Weather-Resistant, Chrome Plated Laminated Steel Body
- Solid Brass Cylinder and 4-Pin Tumbler
- Cushioned Bumper will not Scratch Surfaces
- Each Lock Includes 2-pc. Key Set
- Same Key Opens All Four Locks

Dimensions:

- Body Width: 1-1/2" (40mm)
- Shackle Clearance: 7/8" (22mm) H x 3/4" (19mm) W

| Item | Description | Packaging | Cs | In |
|------|---------------------------------------|--------------------|----|----|
| 7752 | 4-pc. 1-1/2" Laminated Steel Padlocks | SLIDE BLISTER CARD | 24 | 6 |



5-pc. 1-lb. Slide Hammer Dent Puller Set

- Compact, Lightweight, General-Purpose Dent Puller
- 1-lb. Malleable Steel Slide Hammer
- Solid Steel Shaft with Looped Handle for Sure Grip
- Corrosion-Resistant Zinc Finish
- 13" Overall Length, 4" Hammer Travel
- 1-pc. Slide Hammer Dent Puller
- 1-pc. Threaded Nose Cone Adapter
- 3-pc. Pulling Screws

| Item | Description | Packaging | Cs | In |
|------|--|-----------------------|----|----|
| 5624 | 5-pc. 1-lb. Slide Hammer Dent Puller Set | SEALED BLISTER - FULL | 12 | 2 |



9-pc. 5-lb. Slide Hammer Dent Puller Set

- 5-lb. Malleable Steel Slide Hammer
- Solid Steel Shaft with Non-Slip, Fingergrip Handle
- Fully Hardened, Drop Forged Steel Hook and Puller Attachments
- 1-pc. 5-lb. Slide Hammer
- 2-pc. Nose Cones
- 1-pc. Metal Pulling Screw
- 1-pc. Pierce Punch
- 2-pc. Puller Hooks
- 1-pc. Plate Edge Puller
- 1-pc. L-Puller

| Item | Description | Packaging | Cs | In |
|------|--|-----------|----|----|
| 5632 | 9-pc. 5-lb. Slide Hammer Dent Puller Set | COLOR BOX | 9 | 1 |



13-pc. 10-lb. Slide Hammer Dent Puller Set

- 10-lb. Malleable Steel Slide Hammer
- Solid Steel Shaft with Knurled Handle for Sure Grip
- Fully Hardened Drop Forged Steel Hooks, Pullers, and Attachments
- 1-pc. 10-lb. Slide Hammer
- 2-pc. Nose Cones
- 1-pc. Metal Pulling Screw
- 1-pc. Metal Hook and Chain
- 7-pc. Assorted Pullers
- 1-pc. Molded Plastic Case

| Item | Description | Packaging | Cs | In |
|------|--|-------------|----|----|
| 5635 | 13-pc. 10-lb. Slide Hammer Dent Puller Set | COLOR LABEL | 2 | 1 |



5-1/4" Suction Cup Dent Puller

- Rugged One-Piece Molded Rubber Construction
- 5-1/4" Cup Diameter
- Quick Release Pegs
- Pulls Dents Out of Vehicle Panels with no Drilling or Damage to Finish
- Grips Smooth Sheet Materials Like Plate Glass, Paneling, and Sheet Metal for Easy Lifting and Carrying

| Item | Description | Packaging | Cs | In |
|------|--------------------------------|--------------------|----|----|
| 5650 | 5-1/4" Suction Cup Dent Puller | SLIDE BLISTER CARD | 72 | 4 |



4" Suction Cup Dent Puller

- Rugged, High-Impact Nylon Construction
- 4" Diameter Heavy Duty Rubber Suction Cup
- Quick Release Handle
- Pulls Dents Out of Vehicle Panels with no Drilling or Damage to Finish
- Grips Smooth Sheet Materials Like Plate Glass, Paneling, and Sheet Metal for Easy Lifting and Carrying

| Item | Description | Packaging | Cs | In |
|------|----------------------------|--------------------|----|----|
| 5652 | 4" Suction Cup Dent Puller | SLIDE BLISTER CARD | 24 | 2 |



10-in-1 Auto Trim Tool

- Tempered Spring Steel Construction
- Durable Baked Black Enamel Finish
- Universal Trim Tool for Many Foreign and Domestic Cars and Trucks
- 10 Tools in 1: Door Clip Remover, Windshield Molding Clip Release Tool, Headlight Spring Release Tool, Molding Remover, 1/2" Windshield Wiper Wrench, Door Trim Clip Installer, Door Weather Strip Clip Remover, Trim Pad Remover, Window Handle Remover, Panel Seam Cleaner

| Item | Description | Packaging | Cs | In |
|------|------------------------|--------------------|----|----|
| 5871 | 10-in-1 Auto Trim Tool | SLIDE BLISTER CARD | 72 | 6 |



Door Panel Remover

- Drop Forged, Heat Treated Steel
- Chrome Plated for Durability
- Square Mechanic's Vinyl Handle for Sure Grip
- Quickly Removes Plastic Fasteners from Door Panels on Most Foreign and Domestic Cars and Trucks

| Item | Description | Packaging | Cs | In |
|------|--------------------|--------------------|----|----|
| 5873 | Door Panel Remover | SLIDE BLISTER CARD | 72 | 6 |



7-pc. Deluxe Auto Body Repair Kit

- Drop Forged, Heat Treated Steel Heads and Dollies
- Precision-Ground and Polished Faces
- Epoxy-Bonded Fiberglass Handles with Non-Slip Rubber Grips
- Reshape Damaged Body Panels to Original Contour
- 3-pc. Bumping Hammers: Standard Bumping, Reverse-Curve, and Pick-End Finish
- 4-pc. Bumping Dollies: Curved, Utility, Double-End, and Shrinking

| Item | Description | Packaging | Cs | In |
|------|-----------------------------------|-----------|----|----|
| 5655 | 7-pc. Deluxe Auto Body Repair Kit | COLOR BOX | 4 | 1 |



7-pc. Auto Body Repair Kit

- Drop Forged, Heat Treated Steel Heads and Dollies
- Precision-Ground and Polished Faces
- Kiln-Dried Natural Hardwood Handles
- Reshape Damaged Body Panels to Original Contour
- 3-pc. Bumping Hammers: Standard Bumping, Reverse-Curve, and Pick-End Finish
- 4-pc. Bumping Dollies: Curved, Utility, Double-End, and Shrinking

| Item | Description | Packaging | Cs | In |
|------|----------------------------|-----------|----|----|
| 5656 | 7-pc. Auto Body Repair Kit | COLOR BOX | 4 | 1 |



11" Body Filler Scoop

- Easy-Clean Flexible Blade
- Designed to Fit Gallon Can
- Handle Notch Fits Edge of Can Allowing Blade to Reach All Inside Surfaces

| Item | Description | Packaging | Cs | In |
|------|-----------------------|-------------|-----|----|
| 5665 | 11" Body Filler Scoop | COLOR LABEL | 120 | 6 |



3-pc. Body Filler Spreader Set

- Use to Apply Body Filler, Putty and Fiberglass Resin
- Smoothly Applies Filler for Less Sanding and Shaping
- Body Filler and Hardener are Properly Mixed when Color Matches Spreader Color
- Self-Cleaning Material Flexes to Break Off Dried Filler
- 3-pc. Body Filler Spreader Sizes: 2-3/4" x 4", 3" x 5-1/4", 3-1/2" x 6-1/4"

| Item | Description | Packaging | Cs | In |
|------|--------------------------------|--------------------|-----|----|
| 5670 | 3-pc. Body Filler Spreader Set | SLIDE BLISTER CARD | 120 | 6 |



3-Jaw Gear Pullers

- Drop Forged, Heat Treated Steel Jaws with Corrosion-Resistant Chrome Plated Finish
- Precision-Machined Hardened Self-Centering Steel Screw
- 4-Position Reversible Inside/Outside and Shallow/Deep Jaws
- Applies Even Pressure to Remove Gears, Pulleys, and Flywheels from Shaft without Damage

| Item # | Jaw Size | Wrench Needed |
|--------|----------|---------------|
| 5680 | 3" | 9/16" (14mm) |
| 5685 | 4" | 5/8" (16mm) |
| 5690 | 6" | 11/16" (17mm) |
| 5692 | 8" | 7/8" (22mm) |

| Item | Description | Packaging | Cs | In |
|------|----------------------|--------------------|----|----|
| 5680 | 3" 3-Jaw Gear Puller | SLIDE BLISTER CARD | 48 | 6 |
| 5685 | 4" 3-Jaw Gear Puller | SLIDE BLISTER CARD | 20 | 5 |
| 5690 | 6" 3-Jaw Gear Puller | COLOR BOX | 10 | 1 |
| 5692 | 8" 3-Jaw Gear Puller | COLOR BOX | 6 | 1 |



2-Jaw Gear Puller

- Drop Forged, Heat Treated Steel Jaws with Corrosion-Resistant Chrome Plated Finish
- Precision-Machined Hardened Self-Centering Steel Screw
- 4-Position Reversible Inside/Outside and Shallow/Deep Jaws
- Applies Even Pressure to Remove Gears, Pulleys, and Flywheels from Shaft without Damage

| Item # | Jaw Size | Wrench Needed |
|--------|----------|---------------|
| 5681 | 3" | 9/16" (14mm) |
| 5686 | 4" | 5/8" (16mm) |
| 5691 | 6" | 11/16" (17mm) |

| Item | Description | Packaging | Cs | In |
|------|----------------------|--------------------|----|----|
| 5681 | 3" 2-Jaw Gear Puller | SLIDE BLISTER CARD | 50 | 5 |
| 5686 | 4" 2-Jaw Gear Puller | SLIDE BLISTER CARD | 30 | 5 |
| 5691 | 6" 2-Jaw Gear Puller | SLIDE BLISTER CARD | 20 | 5 |



3-pc. Gear Puller Set

- Drop Forged, Heat Treated Steel Jaws with Corrosion-Resistant Chrome Plated Finish
- Precision-Machined Hardened Self-Centering Steel Screw
- 4- or 8-Position Reversible Inside/Outside and Shallow/Deep Jaws
- Applies Even Pressure to Remove Gears, Pulleys, and Flywheels from Shaft without Damage

| Jaw Size | Wrench Needed |
|----------|---------------|
| 3" | 9/16" (14mm) |
| 4" | 5/8" (16mm) |
| 6" | 11/16" (17mm) |

| Item | Description | Packaging | Cs | In |
|------|-----------------------|-----------|----|----|
| 5696 | 3-pc. Gear Puller Set | COLOR BOX | 6 | 1 |



4-pc. Gear Puller

- Drop Forged, Heat Treated Steel Jaws with Corrosion-Resistant Chrome Plated Finish
- Precision-Machined Hardened Self-Centering Steel Screw
- 4- or 8-Position Reversible Inside/Outside and Shallow/Deep Jaws
- Applies Even Pressure to Remove Gears, Pulleys, and Flywheels from Shaft without Damage

| Jaw Size | Wrench Needed |
|----------|---------------|
| 3" | 9/16" (14mm) |
| 4" | 5/8" (16mm) |
| 6" | 11/16" (17mm) |
| 8" | 7/8" (22mm) |

| Item | Description | Packaging | Cs | In |
|------|-------------------|-----------|----|----|
| 5702 | 4-pc. Gear Puller | COLOR BOX | 4 | 1 |



Bearing Separator and Puller Set

- Cast Steel Bearing Splitter and Yoke
- Precision-Machined, Hardened and Tempered Steel Bolts
- Corrosion-Resistant Black Oxide Finish
- Applies Even Pressure to Smoothly Separate Bearings and Remove Gears from Shaft without Damage

- Capacities:
- Bearing Splitter
 - 1-pc. Bearing Splitter
 - 2-pc. 5" x 1/2" (12 TPI) Draw Bolts
 - Min. Spread: 5/8"
 - Max. Spread: 2-1/4"
 - Puller Yoke
 - 4-pc. 6-1/2" Push Puller Legs: 3/8" (16 TPI) x 5/16" (18 TPI)
 - 1-pc. Puller Yoke: 7" Width
 - Width: 7"
 - Center Bolt: 7" x 9/16"
 - 1-pc. 6" Center Screw
 - 2-pc. Center Screw Tips: Cone, Cylinder
 - 2-pc. 4" Puller Jaws: 3/8" (16 TPI)
 - 1-pc. Storage Case

| Item | Description | Packaging | Cs | In |
|------|----------------------------------|-----------|----|----|
| 5704 | Bearing Separator and Puller Set | COLOR BOX | 4 | 1 |



12" Ball Joint Separator

- Drop Forged Heat Treated Steel Construction
- Durable Zinc Plated Finish Resists Corrosion
- Tapered Wedge with 1" Opening
- Non-Slip Knurled Handle Grip
- Slides Between and Separates Ball Joint and Steering Knuckle

| Item | Description | Packaging | Cs | In |
|------|--------------------------|-----------------------|----|----|
| 5732 | 12" Ball Joint Separator | SEALED BLISTER - HALF | 36 | 6 |



16" Tie Rod Separator

- Drop Forged Heat Treated Steel Construction
- Durable Zinc Plated Finish Resists Corrosion
- Tapered Wedge with 7/8" Opening
- Non-Slip Knurled Handle Grip
- Slides Between and Separates Tie Rod End and Steering Knuckle

| Item | Description | Packaging | Cs | In |
|------|-----------------------|-----------------------|----|----|
| 5733 | 16" Tie Rod Separator | SEALED BLISTER - HALF | 24 | 6 |

17-pc. 5-lb. Slide Hammer Puller Set

- 5-lb. Malleable Steel Slide Hammer
- Solid Steel T-Handle Shaft
- Fully Hardened Alloy Steel Attachments
- Includes Combination Puller, 2- and 3-Jaw Gear Puller, Dent and Panel Puller Attachments
- 1-pc. 5-lb. Slide Hammer
- 1-pc. Dent Puller Bar
- 3-pc. Screw, Hook, and Axle Adapters
- 1-pc. Dent Puller Screw Attachment
- 3-pc. Gear Puller Arms
- 1-pc. 2-Jaw Gear Pulling Head
- 1-pc. 3-Jaw Gear Pulling Head
- 1-pc. Locking Pliers Adapter
- 3-pc. Hardened Steel Bolts
- 1-pc. Locking Nut
- 1-pc. Molded Plastic Case

| Item | Description | Packaging | Cs | In |
|------|--------------------------------------|--------------|----|----|
| 5645 | 17-pc. 5-lb. Slide Hammer Puller Set | COLOR SLEEVE | 2 | 1 |





Single-Action Internal Coil Spring Compressor

- Forged and Hardened Chrome Vanadium Steel Arms
- Cold-Rolled, Fine-Thread Steel Center Screw
- Corrosion-Resistant Black Oxide Finish
- Internally Mounted Compressor for Springs that can be Reached Through Center of Coil

Specifications:

- Max. Spring Capacity: 5-5/8" O.D. x 3/4" Wire Diameter
- Overall Length: 11-1/2"
- Wrench Needed: 15/16" (23mm)

| Item | Description | Packaging | Cs | In |
|------|---|--------------------|----|----|
| 5734 | Single-Action Internal Coil Spring Compressor | SLIDE BLISTER CARD | 12 | 3 |



Coil Spring Compressor Set

- Heavy Duty Cast Steel Arms
- Precision-Machined Hardened Steel Center Screws
- Compresses Coil Spring Allowing Removal from MacPherson Strut Assembly
- Fits Most Common Spring Sizes

| Item | Description | Packaging | Cs | In |
|------|----------------------------|-----------|----|----|
| 5737 | Coil Spring Compressor Set | COLOR BOX | 12 | 1 |



Pilot Bearing Puller

- Forged and Heat Treated Chrome Vanadium Steel Jaws
- Corrosion-Resistant Black Oxide Finish
- Three Jaw Design Applies Even Pressure Preventing Damage to Bearings
- Fits all 3/4" - 2" I.D. Sleeve-Type Bearings
- Pulls Pilot Bearings, Pump Bearings, and Bushings

| Item | Description | Packaging | Cs | In |
|------|----------------------|-----------------------|----|----|
| 5740 | Pilot Bearing Puller | SEALED BLISTER - FULL | 24 | 6 |



Seal Puller

- Heat Treated Double-End Steel Head with Two Tip Sizes
- Black Oxide Finish Resists Corrosion
- Nickel Plated Tubular Steel Shaft
- Oversized Mechanic-Style Handle
- Removes Worn Grease and Oil Seals

| Item | Description | Packaging | Cs | In |
|------|-------------|-----------------------|----|----|
| 5741 | Seal Puller | SEALED BLISTER - HALF | 48 | 6 |



Bearing Packer

- Galvanized Steel Construction
- Hardened and Tempered, Precision-Machined Steel Grease Conduit
- Use with Air or Hand-Operated Grease Guns
- Fast, Efficient Way to Force Out Old Grease and Evenly Inject Fresh Grease
- Can be Used as a Portable or Bench-Mounted Packer
- Capacity: 5-5/16" Outer Diameter 25/64" Inner Diameter 2" Max. Working Height

| Item | Description | Packaging | Cs | In |
|------|----------------|--------------------|----|----|
| 5743 | Bearing Packer | SLIDE BLISTER CARD | 36 | 6 |



Steering Wheel Puller

- Drop Forged, Heat Treated Steel Yoke
- Hardened and Tempered, Precision-Machined Center Bolt with Floating Swivel Adapter
- Corrosion-Resistant Zinc Plated Finish
- Applies Even Pressure to Remove Steering Wheel from Shaft without Damage
- 1-pc. Yoke
- 1-pc. Center Screw
- 2-pc. Washers
- 1-pc. Floating Swivel
- 2-pc. 5/16" x 18 TPI Puller Bolts
- 2-pc. 5/16" x 24 TPI Puller Bolts
- 2-pc. 3/8" x 16 TPI Puller Bolts

| Item | Description | Packaging | Cs | In |
|------|-----------------------|-----------------------|----|----|
| 5745 | Steering Wheel Puller | SEALED BLISTER - FULL | 36 | 6 |

Pitman Arm Puller

- Drop Forged, Heat Treated Steel Yoke
- Zinc Plated Finish Resists Corrosion
- Hardened and Tempered, Precision-Machined Center Screw
- Smoothly Pulls Pitman Arm from Mount without Damage

- Specifications:
- Wrench Size: 3/4"/19mm or 3/8" Direct Drive
 - Jaw Opening: 1-5/16" (33mm)
 - Inside Jaw Width: 2-1/2" (64mm)
 - Throat Depth: 2-1/4" (57mm)

| Item | Description | Packaging | Cs | In |
|------|-------------------|--------------------|----|----|
| 5747 | Pitman Arm Puller | SLIDE BLISTER CARD | 24 | 6 |

13-pc. Harmonic Balancer Puller

- Rugged Cast Steel Yoke
- Center Screw with Removable Swivel Tip
- Precision-Machined Bolts
- Multi-Purpose Puller Applies Pressure to Hub to Safely Remove Harmonic Balancers, Crankshaft Pulleys, and Steering Wheels
- 1-pc. Yoke
- 1-pc. Center Screw
- 1-pc. Center Screw Tip
- 3-pc. 1/4" (18 TPI) x 2" Puller Bolts
- 3-pc. 3/8" (24 TPI) x 2" Puller Bolts
- 2-pc. 3/8" (16 TPI) x 3-3/4" Puller Bolts
- 2-pc. 5/16" (20 TPI) x 3" Puller Bolts

| Item | Description | Packaging | Cs | In |
|------|---------------------------------|-----------------------|----|----|
| 5750 | 13-pc. Harmonic Balancer Puller | SEALED BLISTER - FULL | 20 | 5 |



46-pc. Harmonic Balance Puller

- Rugged Drop Forged, Heat Treated Steel Yoke
- Universal Yoke Design for 2- and 3-Bolt Applications
- Hardened and Tempered, Precision-Machined Center Bolt with Three Tip Adapters
- Multi-Purpose Puller Applies Pressure to Hub to Safely Remove Harmonic Balancers, Crankshaft Pulleys, and Steering Wheels
- 1-pc. Yoke
- 1-pc. Center Screw
- 3-pc. Center Screw Tip Adapters
- 3-pc. 3/8" (24 TPI) x 1-1/2" Puller Bolts
- 3-pc. 3/8" (16 TPI) x 2" Puller Bolts
- 3-pc. 3/8" (16 TPI) x 3" Puller Bolts
- 2-pc. 3/8" (16 TPI) x 4-1/2" Puller Bolts
- 2-pc. 5/16" (18 TPI) x 6" Puller Bolts
- 3-pc. 5/16" (18 TPI) x 3-1/2" Puller Bolts
- 2-pc. 5/16" (24 TPI) x 3" Puller Bolts
- 3-pc. 5/16" Washers
- 2-pc. 1/4" (28 TPI) x 2-1/2" Puller Bolts
- 2-pc. 1/4" Washers
- 3-pc. M10 (1.5mm) x 35mm Puller Bolts
- 3-pc. 10mm Washers
- 3-pc. M8 (1.25mm) x 45mm Puller Bolts
- 2-pc. M8 (1.25mm) x 65mm Puller Bolts
- 2-pc. M8 (1.25mm) x 90mm Puller Bolts
- 3-pc. 8mm Washers



| Item | Description | Packaging | Cs | In |
|------|--------------------------------|-----------------------|----|----|
| 5755 | 46-pc. Harmonic Balance Puller | SEALED BLISTER - FULL | 12 | 6 |



Battery Post and Terminal Brush

- Tough Stainless Steel Brushes
- Steel Housing with Durable Nickel Plated Finish
- Internal Brush Cleans Battery Posts, Cone Brush Cleans Battery Terminals
- Removes Dirt, Debris and Corrosion to Restore Electrical Contact

| Item | Description | Packaging | Cs | In |
|------|---------------------------------|--------------------|-----|----|
| 5780 | Battery Post and Terminal Brush | SLIDE BLISTER CARD | 288 | 12 |



4-Way Battery Post and Terminal Cleaner

- Solid Aluminum Alloy Construction
- Positive and Negative Post Cleaners with Tempered Spring Steel Scrapers
- 8-Fin Forged Steel Ream is Tapered to Fit Positive and Negative Battery Terminals
- Works with Most Top Terminal Batteries
- Removes Dirt, Debris and Corrosion to Restore Electrical Contact

| Item | Description | Packaging | Cs | In |
|------|---|-----------|----|----|
| 5785 | 4-Way Battery Post and Terminal Cleaner | HANG CARD | 72 | 6 |



12 V Continuity Tester

- Tests 6-12 VDC Automotive and Small Equipment Electrical Systems
- Checks Circuit Continuity and Identifies Blown Fuses or Light Bulbs
- Sharp Steel Probe Reaches into Fuse Boxes or Pierces Insulation to Contact Wire
- Indicator Light in Handle Glows when Circuit is Completed
- 54" Heavy Duty Test Lead with Alligator Clip

| Item | Description | Packaging | Cs | In |
|------|------------------------|--------------------|----|----|
| 5891 | 12 V Continuity Tester | SLIDE BLISTER CARD | 72 | 12 |



12 V Continuity Tester

- Tests 6-12 VDC Automotive and Small Equipment Electrical Systems
- Checks Circuit Continuity and Identifies Blown Fuses or Light Bulbs
- Sharp Steel Probe Reaches into Fuse Boxes or Pierces Insulation to Contact Wire
- Indicator Light in Handle Glows when Circuit is Completed
- 24" Test Lead with Alligator Clip

| Item | Description | Packaging | Cs | In |
|------|------------------------|--------------------|-----|----|
| 5892 | 12 V Continuity Tester | SLIDE BLISTER CARD | 120 | 12 |



12 V In-Line Spark Tester

- Simple In-line Connection Between Spark Plug Wire and Spark Plug
- Tests for Continuity of Ignition Circuit
- Indicator Light Flashes when Ignition Circuit is Complete

| Item | Description | Packaging | Cs | In |
|------|---------------------------|--------------------|----|----|
| 5889 | 12 V In-Line Spark Tester | SLIDE BLISTER CARD | 72 | 6 |



15-pc. Auto Fuse Set

- Six Most Common Fuse Sizes
- Chip-Type Fuses Meet or Exceed OEM Specifications
- Color Coded for Easy Identification
- Keep in Glove Box for Fast, Easy, Economical Repairs
- 2-pc. 5 AMPS
- 3-pc. 10 AMPS
- 3-pc. 15 AMPS
- 3-pc. 20 AMPS
- 2-pc. 25 AMPS
- 2-pc. 30 AMPS

| Item | Description | Packaging | Cs | In |
|------|----------------------|--------------------|-----|----|
| 6066 | 15-pc. Auto Fuse Set | SLIDE BLISTER CARD | 300 | 10 |



Disc Brake Pad Spreader

- Large, Comfortable 4-Flute Poly Handle
- Rugged 5/32" Steel Spreader Plate
- Zinc-Plated Steel Center Screw and Swivel Foot
- Compresses Disc Brake Caliper Piston to Allow New Pad Installation

| Item | Description | Packaging | Cs | In |
|------|-------------------------|--------------------|----|----|
| 5806 | Disc Brake Pad Spreader | SLIDE BLISTER CARD | 48 | 6 |



5-in-1 3/8" Drive Disc Brake Piston Retractor

- Heat Treated Chrome Plated Die Cast Zinc
- Rotates Caliper Piston Back into Bore on Actuator-Screw Rear Disc Brakes to Allow New Pad Installation
- Universal 5-in-1 Cube Design Fits Most Piston Lug Patterns
- 3/8" Drive

| Item | Description | Packaging | Cs | In |
|------|---|--------------------|----|----|
| 5807 | 5-in-1 3/8" Drive Disc Brake Piston Retractor | SLIDE BLISTER CARD | 72 | 6 |



Brake Bleeder Kit

- 3-pc. Nylon Adapters Fit All Brakes
- Plastic Bottle Collects Discharged Fluid
- Magnetic Pad Holds Collection Bottle to Metal Frame

| Item | Description | Packaging | Cs | In |
|------|-------------------|--------------------|----|----|
| 5808 | Brake Bleeder Kit | SLIDE BLISTER CARD | 72 | 6 |



12" Brake Spring Pliers

- Rugged Heat Treated Steel Construction
- Corrosion-Resistant Chrome Plated Finish
- All-in-One Drum Brake Spring Tool Removes and Installs Retaining, Return, and Hold-Down Springs

| Item | Description | Packaging | Cs | In |
|------|-------------------------|--------------------|----|----|
| 5810 | 12" Brake Spring Pliers | SLIDE BLISTER CARD | 48 | 6 |



5" Brake Retainer Spring Tool

- Drop Forged, Heat Treated Steel Compressor Cup
- Hardened and Tempered Steel Shaft
- Durable Black Oxide Finish
- Square Mechanic's-Style Handle
- Knurled Cup Securely Grips Washer
- Removes and Replaces Brake Shoe Retaining Spring Caps With a 3/4" Diameter Spring

| Item | Description | Packaging | Cs | In |
|------|-------------------------------|--------------------|----|----|
| 5812 | 5" Brake Retainer Spring Tool | SLIDE BLISTER CARD | 48 | 6 |



7-pc. Drum Brake Tool Set

- Complete Assortment of Common Drum Brake Repair Tools
- Forged, Heat Treated Carbon Steel
- Corrosion-Resistant Chrome Plated Finish
- Precision-Machined 6-Point Box End Wrenches
- 1-pc. Retainer Spring Tool
- 1-pc. Brake Spring/Clip Tool
- 3-pc. Double-Box-End Bleeder Wrenches (6-Point): 1/4" x 3/8", 5/16" x 3/8", 90° 8mm x 10mm
- 2-pc. Brake Shoe Adjuster Tools

| Item | Description | Packaging | Cs | In |
|------|---------------------------|-----------|----|----|
| 5820 | 7-pc. Drum Brake Tool Set | COLOR BOX | 20 | 1 |



Universal Chain Oil Filter Wrench

- Fully Adjustable Universal Chain Design Fits Any Diameter Oil Filter up to 5"
- Applies a Non-Slip Grip to Remove Even Difficult Filters
- Compact Construction is Ideal for Cramped Engine Compartments
- Comfortable Cushioned Handle Grip

| Item | Description | Packaging | Cs | In |
|------|-----------------------------------|--------------------|----|----|
| 5862 | Universal Chain Oil Filter Wrench | SLIDE BLISTER CARD | 72 | 6 |



Filter Claw Oil Filter Pliers

- Drop Forged, Heat Treated Steel with Rust-Resistant Finish
- Aggressive Teeth Grip Even Greasy or Oil-Covered Filters
- Non-Slip Cushioned Handles
- 3-Position Slip Joint Hinge Adjusts to Fit Oil Filter Sizes up to 4-1/2"

| Item # | Max. Filter Size |
|--------|------------------|
| 5866 | 4-1/2" |
| 5867 | 5-1/2" |

| Item | Description | Packaging | Cs | In |
|------|-----------------------|-------------------------|----|----|
| 5866 | 12" Oil Filter Pliers | HALF SLIDE BLISTER CARD | 48 | 6 |
| 5867 | 16" Oil Filter Pliers | HALF SLIDE BLISTER CARD | 24 | 6 |



3-3/4" Flex Oil Filter Wrench

- Rugged Hardened Steel Handle and Flex Head
- Non-Slip Cushioned Handle Grip
- 180° Flex Head for Access in Tight Engine Compartments
- Automatically Adjusts to Fit Oil Filter Sizes 3-1/4" to 3-3/4" Diameter

| Item | Description | Packaging | Cs | In |
|------|-------------------------------|-----------|----|----|
| 5868 | 3-3/4" Flex Oil Filter Wrench | HANG CARD | 72 | 6 |



4-Pc. Funnel Set

- Lightweight Polyethylene Construction
 - Bright Red Color is Easy to Locate in Work Area
 - Use for Oil, Coolant, Gasoline, Kerosene, and other Fluids
- 4-pc. Funnel Set: 2" (2 fl. oz.), 3" (3 fl. oz.) 4" (7 fl. oz.), 5" (13 fl. oz.)

| Item | Description | Packaging | Cs | In |
|------|------------------|-------------|----|----|
| 6093 | 4-pc. Funnel Set | COLOR LABEL | 36 | 6 |



2-In-1 Deluxe Funnel Set

- Heavy Duty Polyethylene Construction
- Mesh Screen Filters Out Damaging Particles from Fluids
- Convenient Handle on Side
- Use for Engine Oil, Coolant, Gasoline, Kerosene, Engine Fluids, etc
- 2-in-1 Deluxe Funnel: 7-1/2" Funnel with 8" Flexible Extension
- 40 oz. Capacity

| Item | Description | Packaging | Cs | In |
|------|--------------------------|-------------|----|----|
| 6094 | 2-in-1 Deluxe Funnel Set | COLOR LABEL | 36 | 6 |

2-pc. Distributor Wrench Set

- Forged and Hardened Carbon Steel
- Corrosion-Resistant Chrome Plated Finish
- Offset Design Easily Reaches Distributor Lock Nut
- 3/8" Drive Ratchet Adapter
- Wrench Sizes: 9/16" and 1/2"

| Item | Description | Packaging | Cs | In |
|------|------------------------------|--------------------|----|----|
| 5850 | 2-pc. Distributor Wrench Set | SLIDE BLISTER CARD | 48 | 6 |



Parts Cleaning Brush

- Heavy Duty Nylon Bristles
- Tapered Natural Hardwood Handle
- 10-1/2" Overall Length

| Item | Description | Packaging | Cs | In |
|------|----------------------|-----------|----|----|
| 5880 | Parts Cleaning Brush | HANG CARD | 36 | 12 |



Spark Plug Terminal Pliers

- Drop Forged, Heat Treated Steel
- Corrosion-Resistant Nickel Plated Finish
- Cushioned Tips Grip Spark Plug Terminals without Damage for Removal or Installation
- Cushioned Non-Slip Handle Grips

| Item | Description | Packaging | Cs | In |
|------|----------------------------|--------------------|-----|----|
| 5886 | Spark Plug Terminal Pliers | SLIDE BLISTER CARD | 144 | 6 |



Mechanic's Stethoscope

- Comfortable, Spring-Return Ear Pieces Stay in Place
- Aluminum and Flexible Vinyl Tubing Construction
- 4" Steel Probe with 8" Extension
- Locate Trouble Spots within Engine Block

| Item | Description | Packaging | Cs | In |
|------|------------------------|--------------------|----|----|
| 5888 | Mechanic's Stethoscope | SLIDE BLISTER CARD | 48 | 6 |





4-pc. Mini Pick and Hook Set

- Heat Treated, Chrome Vanadium Steel Shafts
- Knurled Grip Section on Shaft for Precise Handling
- Comfortable Contoured Handles
- 1-pc. Full Hook
- 1-pc. 45-degree
- 1-pc. 90-degree
- 1-pc. Straight Pick

| Item | Description | Packaging | Cs | In |
|------|------------------------------|--------------------|----|----|
| 6942 | 4-pc. Mini Pick and Hook Set | SLIDE BLISTER CARD | 72 | 12 |



4-pc. Precision Pick and Hook Set

- Heat Treated, Chrome Vanadium Steel Shafts
- Cushioned, Non-Slip Grips for Extra Control
- Knurled Shaft Grip Area for Precise Work
- Ideal For Assembly, Repair, or Removal of Small Parts
- 1-pc. Full Hook
- 1-pc. 45-degree
- 1-pc. 90-degree
- 1-pc. Straight Pick

| Item | Description | Packaging | Cs | In |
|------|-----------------------------------|-----------------------|----|----|
| 6943 | 4-pc. Precision Pick and Hook Set | SEALED BLISTER - HALF | 72 | 6 |



12" Long Reach Scraper

- Rugged Steel Blade Holder
- Strong Tubular Steel Shaft
- High-Impact Clear Handle with Blade Storage Compartment
- Extra Long 12" Length Reaches into Tight Spots
- Removes Decals, Tape, and Adhesive Residue from Windows and Mirrors
- 1-pc. Scraper
- 3-pc. Scraper Blades

| Item | Description | Packaging | Cs | In |
|------|------------------------|--------------------|----|----|
| 5878 | 12" Long Reach Scraper | SLIDE BLISTER CARD | 72 | 6 |



Gasket Scraper

- Drop Forged Heat Treated Carbon Steel
- Rugged Square 3/8" Stock Shaft
- Black Oxide Finish Resists Corrosion
- Comfortable Contoured Handle
- 1" Wide Blade Scrapes Mating Surfaces Clean for Installing New Gaskets

| Item | Description | Packaging | Cs | In |
|------|----------------|--------------------|----|----|
| 5876 | Gasket Scraper | SLIDE BLISTER CARD | 72 | 12 |



5-pc. Professional Scraper and Remover Set

- Drop Forged, Heat Treated Steel
- Precision Ground and Formed Blade Tips
- Black Oxide Finished for Durability
- Scrapers Have 1" Wide, Bevel-Edged Blades
- Square Mechanic's Vinyl Handles for a Comfortable Grip
- 1-pc. 9" Cotter Pin Puller
- 1-pc. 8" Scratch Awl
- 1-pc. 7" Radiator Hose Remover
- 1-pc. 11" Multi-Purpose Scraper
- 1-pc. 8-1/2" Multi-Purpose Scraper

| Item | Description | Packaging | Cs | In |
|------|--|-----------------------|----|----|
| 6945 | 5-pc. Professional Scraper and Remover Set | SEALED BLISTER - FULL | 20 | 1 |



22" x 5/8" Universal Lockout Tool

- Universal Catch Tip Design Releases Many Common Vehicle Door Lock Configurations
- Bendable, Ultra-Slim Spring Steel Construction Easily Slides Between Window and Weather Stripping
- Dimensions: 22" L x 5/8" W x 0.7mm

| Item | Description | Packaging | Cs | In |
|------|-----------------------------------|-----------|-----|----|
| 6062 | 22" x 5/8" Universal Lockout Tool | SKIN CARD | 200 | 20 |



22" x 1-1/4" Universal Lockout Tool

- Universal Catch Tip Design Releases Many Common Vehicle Door Lock Configurations
- Bendable, Ultra-Slim Spring Steel Construction Easily Slides Between Window and Weather Stripping
- Dimensions: 22" L x 1-1/4" W x 0.7mm

| Item | Description | Packaging | Cs | In |
|------|-------------------------------------|-----------|-----|----|
| 6064 | 22" x 1-1/4" Universal Lockout Tool | SKIN CARD | 200 | 20 |



2-pc. 2" Blind Spot Mirror Set

- Strong, Weather-Resistant Adhesive
- Attaches to Vehicle Mirrors
- Allows You to See Vehicles, Pedestrians, and Obstacles Hiding in Your Blind Spots

| Item | Description | Packaging | Cs | In |
|------|--------------------------------|--------------------|-----|----|
| 6060 | 2-pc. 2" Blind Spot Mirror Set | SLIDE BLISTER CARD | 240 | 12 |



2-pc. 3" Blind Spot Mirrors

- Strong, Weather-Resistant Adhesive
- Attaches to Vehicle Mirrors
- Allows You to See Vehicles, Pedestrians, and Obstacles Hiding in Your Blind Spots

| Item | Description | Packaging | Cs | In |
|------|-----------------------------|--------------------|-----|----|
| 6061 | 2-pc. 3" Blind Spot Mirrors | SLIDE BLISTER CARD | 144 | 12 |



Pencil Tire Gauges - 100 PSI

- Calibrated from 10 - 100 PSI
- 45° Angled Chuck with Valve Depressor
- Spring Pocket Clip
- Save Gas and Tire Wear with Proper Inflation

| Item | Description | Packaging | Cs | In |
|-------|-----------------------------|--------------------|-----|----|
| 5930 | Pencil Tire Gauge - 100 PSI | SLIDE BLISTER CARD | 250 | 10 |
| 59301 | Pencil Tire Gauge - 100 PSI | 72-PC. FISHBOWL | 4 | 1 |
| 5932 | Pencil Tire Gauge - 100 PSI | SLIDE BLISTER CARD | 250 | 10 |

Pencil Tire Gauge - 120 PSI

- Calibrated from 10 - 120 PSI
- Durable Chrome Plated Metal Housing
- 45° Angled Dual Foot Chuck
- Spring Pocket Clip
- Save Gas and Tire Wear with Proper Inflation

| Item | Description | Packaging | Cs | In |
|------|-----------------------------|--------------------|-----|----|
| 5940 | Pencil Tire Gauge - 120 PSI | SLIDE BLISTER CARD | 240 | 12 |



Dial Tire Gauge - 50 PSI

- Calibrated from 5 - 50 PSI
- Impact-Resistant ABS Housing
- Easy-Read High-Contrast Dial Face
- Holds Dial Reading until Reset Button is Pressed
- 45° Angled Chuck with Valve Depressor
- Save Gas and Tire Wear with Proper Inflation

| Item | Description | Packaging | Cs | In |
|------|--------------------------|--------------------|-----|----|
| 5935 | Dial Tire Gauge - 50 PSI | SLIDE BLISTER CARD | 250 | 10 |



Dial Tire Gauge - 100 PSI

- Calibrated from 10 - 100 PSI
- Durable Metal Housing with Black Enamel Finish
- Easy-Read High-Contrast Dial Face
- Holds Dial Reading until Reset Button is Pressed
- 45° Angled Chuck with Valve Depressor
- Save Gas and Tire Wear with Proper Inflation

| Item | Description | Packaging | Cs | In |
|------|---------------------------|--------------------|-----|----|
| 5938 | Dial Tire Gauge - 100 PSI | SLIDE BLISTER CARD | 150 | 10 |



Digital Tire Gauge - 100 PSI

- Lighted Nozzle and Display for Easy Measurements
- Push-Button On/Range Selector with Auto Shut-Off
- Non-Slip Ergonomic Pistol Grip Design

Specifications:
 Measurement Ranges (4):
 PSI: 0 - 100, Bar: 0 - 7, KPA: 0-700, Kg/cm2: 0-7
 Min. Increment: 0.5 PSI
 Battery: One CR2032 3V Lithium Coin Cell (Included)

| Item | Description | Packaging | Cs | In |
|------|------------------------------|--------------------|----|----|
| 5941 | Digital Tire Gauge - 100 PSI | SLIDE BLISTER CARD | 72 | 6 |

Brass Tire Chucks

- 5950
- Solid Brass Construction
 - Precision-Machined for Leak-Proof Operation
 - 45° Angled Head
 - Air Inlet: 1/4" NPT

- 5952
- Solid Brass Construction
 - Precision-Machined for Leak-Proof Operation
 - 45° Angled Head
 - Lever Locks Chuck to Valve Stem
 - Air Inlet: 1/4" NPT



| Item | Description | Packaging | Cs | In |
|------|----------------------------------|--------------------|-----|----|
| 5950 | Brass Tire Chuck | SLIDE BLISTER CARD | 250 | 10 |
| 5952 | Brass Tire Chuck with Lever Lock | SLIDE BLISTER CARD | 200 | 25 |



Dual Tire Chuck

- Precision Zinc-Cast Construction
- Offset Dual Chuck Allows Easy Access to Valve Stems
- Female 1/4" NPT
- 6" Overall Length

| Item | Description | Packaging | Cs | In |
|------|-----------------|--------------------|-----|----|
| 5955 | Dual Tire Chuck | SLIDE BLISTER CARD | 100 | 10 |



18-pc. Tire Plug Repair Kit

- All-in-One Kit with Everything you Need to Repair Puncture-Damaged Tires
- Heavy Duty, Solid Steel T-Handle with Durable Chrome Plated Finish
- Precision-Machined Interchangeable Steel Rasp and Open Eye Tools

- 1-pc. T-Handle
- 1-pc. Rasp Tool
- 1-pc. Open Eye Tool
- 1-pc. Hex Key
- 1-pc. Plug Strip Cutter
- 12-pc. Tire Plug Strips
- 1-pc. Rubber Cement

| Item | Description | Packaging | Cs | In |
|------|-----------------------------|--------------------|----|----|
| 5962 | 18-pc. Tire Plug Repair Kit | SLIDE BLISTER CARD | 48 | 6 |



Foot Pump

- All-Steel Construction with Durable Enamel Finish
- Easy Read Gauge Calibrated from 0 - 100 PSI
- Lever Locks Chuck to Valve Stem
- Foot Pedal with Non-Slip Rubber Tread
- 16" Air Hose
- Three Nozzle Adapters for Inflating Bicycle Tires, Toys, Sporting Equipment and Air Mattresses

| Item | Description | Packaging | Cs | In |
|------|-------------|-----------------------|----|----|
| 6090 | Foot Pump | SEALED BLISTER - FULL | 10 | 1 |



Tire Inflator with Gauge

- Cast Aluminum Alloy Body with Brass Valves
- 12" Flexible, Industrial-Grade Rubber Hose
- 6" Tire Chuck with 45° Angled Dual Foot
- Built-in, Dual-Range 120 PSI (10 kg/cm2) Pressure Gauge

Specifications:

- Air Inlet (F): 1/4" NPT
- Maximum Air Pressure: 120 PSI
- Pressure Gauge: 10-120 PSI (1-10 kg/cm2)

| Item | Description | Packaging | Cs | In |
|------|--------------------------|--------------------|----|----|
| 5960 | Tire Inflator with Gauge | SLIDE BLISTER CARD | 25 | 5 |

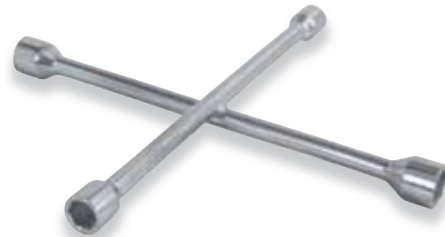

4-Way Lug Wrenches

5974

- Forged Heat Treated Steel
- Rugged Welded Cross Design for Two-Handed Torque
- Chrome Plated Finish Resists Corrosion
- 6-Point Wrenches (MM): 17, 19, 21, and 23mm

5975

- Forged Heat Treated Steel
- Rugged Welded Cross Design for Two-Handed Torque
- Chrome Plated Finish Resists Corrosion
- 6-Point Wrenches (SAE/MM): 3/4", 13/16", 7/8", and 19mm

| Item | Description | Packaging | Cs | In |
|------|----------------------|------------------------|----|----|
| 5974 | 14" 4-Way Lug Wrench | PLASTIC HANG TAB/LABEL | 12 | 3 |
| 5975 | 20" 4-Way Lug Wrench | PLASTIC HANG TAB/LABEL | 12 | 3 |

20" Tire Pump

- Rugged Steel Cylinder
- Non-Slip Soft Grip T-Handle
- Solid Cast Base with Fold Down Foot Pegs for Stable Operation
- Lever Locks Chuck to Valve Stem
- 21" Air Hose
- Three Nozzle Adapters for Inflating Bicycle Tires, Toys, Sporting Equipment and Air Mattresses



| Item | Description | Packaging | Cs | In |
|------|---------------|-----------------------|----|----|
| 6092 | 20" Tire Pump | SEALED BLISTER - HALF | 12 | 1 |



Hydraulic Bottle Jacks

- Heavy Gauge Steel Construction
- One-Piece, Drop Forged Base for Increased Strength and Stability
- 2-Piece Handle Provides Maximum Results with Minimal Effort
- Screw Top Extends Range and Allows Easy Height Adjustment

| Item # | Lifting Capacity | Min. Clearance | Max. Lifting Height |
|--------|------------------|----------------|---------------------|
| 5470 | 2-TON | 7-1/8" | 13-1/2" |
| 5475 | 4-TON | 7-5/8" | 15" |
| 5480 | 6-TON | 8-1/2" | 16-3/4" |
| 5485 | 8-TON | 9" | 18-1/4" |
| 5490 | 12-TON | 9-1/16" | 18-5/16" |
| 5495 | 20-TON | 9-1/2" | 18-3/16" |

| Item | Description | Packaging | Cs | In |
|------|------------------------------|-----------|----|----|
| 5470 | 2 Ton Hydraulic Bottle Jack | COLOR BOX | 6 | 1 |
| 5475 | 4 Ton Hydraulic Bottle Jack | COLOR BOX | 6 | 1 |
| 5480 | 6 Ton Hydraulic Bottle Jack | COLOR BOX | 4 | 1 |
| 5485 | 8 Ton Hydraulic Bottle Jack | COLOR BOX | 4 | 1 |
| 5490 | 12 Ton Hydraulic Bottle Jack | COLOR BOX | 3 | 1 |
| 5495 | 20 Ton Hydraulic Bottle Jack | COLOR BOX | 2 | 1 |



2-1/4 Ton Garage Jack

- 5" Lifting Saddle Swivels 360° for Proper Fit
- Dual Heavy Duty 1/4" Steel Lifting Arms
- Solid Steel Casters on Front (3-1/2") and Rear (2" Swivel Ball Bearing)
- Handle-Controlled Lifting and Lowering
- 2-Piece Handle with Non-Slip, Rubber Grip
- Conforms to ANSI / ASME Safety Standards

| Min. Clearance | Lifting Height |
|----------------|----------------|
| 5" | 19-1/4" |

| Item | Description | Packaging | Cs | In |
|------|-----------------------|-----------|----|----|
| 5510 | 2-1/4 Ton Garage Jack | COLOR BOX | 1 | 1 |



Rope Hoist

- 65ft. Poly Rope with a 500-lb. Lifting Capacity
- Chrome Plated Steel Pulleys
- Heavy Duty Nylon Wheels
- Compact and Lightweight
- Easy-To-Use Both Outdoors and Indoors

| Item | Description | Packaging | Cs | In |
|------|-------------|--------------------|----|----|
| 5550 | Rope Hoist | SLIDE BLISTER CARD | 40 | 10 |



Power Pullers

- Powerful Ratcheting System Pulls Heavy Loads with Less Effort
- Use for Construction, Landscaping, Loading/Unloading, and Farm Applications
- Hardened All-Steel Construction with Corrosion-Resistant Galvanized Finish
- Laminated Steel Gear and Locking Pawl
- High-Tensile-Strength Aircraft-Grade Braided Steel Cable
- Drop Forged Self-Closing Safety Catch Hooks
- High-Leverage Ratchet Handle with Cushioned Non-Slip Grip
- Automatic Notch-at-a-Time Letdown Controls Heavy Loads During Descent

| Item # | Pulling Capacity | Max. Pull Length |
|--------|------------------|------------------|
| 5541 | 4000 LBS | 7' 10" |
| 5546 | 8000 LBS | 7' 3" |

| Item | Description | Packaging | Cs | In |
|------|--------------------|-----------|----|----|
| 5541 | 2-Ton Power Puller | COLOR BOX | 6 | 1 |
| 5546 | 4-Ton Power Puller | COLOR BOX | 4 | 1 |



Dual Gear Power Pullers

- Powerful Ratcheting System Pulls Heavy Loads with Less Effort
- Use for Construction, Heavy Equipment, Loading/Unloading, and Farm Applications
- Heavy Gauge All-Steel Construction with Corrosion-Resistant Galvanized Finish
- Dual Solid Steel Gears and Locking Pawls Distribute Pulling Force Evenly
- Rugged One Piece Frame Design
- High-Tensile-Strength Aircraft-Grade Braided Steel Cable
- Drop Forged Self-Closing Safety Catch Hooks
- High-Leverage Ratchet Handle with Cushioned Non-Slip Grip
- Automatic Notch-at-a-Time Letdown Controls Heavy Loads During Descent

| Item # | Pulling Capacity | Max. Pull Length |
|--------|------------------|------------------|
| 5542 | 4000 LBS | 7' 3" |
| 5547 | 8000 LBS | 7' 3" / 12' 7" |

| Item | Description | Packaging | Cs | In |
|------|------------------------------|-----------|----|----|
| 5542 | 2-Ton Dual Gear Power Puller | COLOR BOX | 6 | 1 |
| 5547 | 4-Ton Dual Gear Power Puller | COLOR BOX | 4 | 1 |



1-Ton Power Pullers

- Powerful Ratcheting System Pulls Heavy Loads with Less Effort
- Use for Light Construction, Landscaping, Loading/Unloading, and Farm Applications
- Hardened All-Steel Construction with Corrosion-Resistant Galvanized Finish
- Laminated Steel Gear and Locking Pawl
- High-Tensile-Strength Aircraft-Grade Braided Steel Cable
- Drop Forged Self-Closing Safety Catch Hooks
- High-Leverage Ratchet Handle with Cushioned Non-Slip Grip
- Automatic Notch-at-a-Time Letdown Controls Heavy Loads During Descent

| Item # | Pulling Capacity | Max. Pull Length |
|--------|------------------|------------------|
| 5543 | 2000 LBS | 7' 6" |
| 5544 | 2000 LBS | 7' 6" |

| Item | Description | Packaging | Cs | In |
|------|------------------------------|-----------|----|----|
| 5543 | 1-Ton Power Puller | COLOR BOX | 10 | 1 |
| 5544 | 1-Ton Dual Gear Power Puller | COLOR BOX | 10 | 1 |

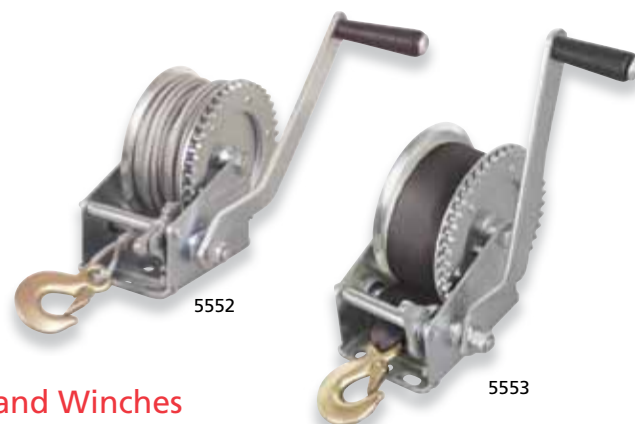

Hand Winches

- 1200-Lb. Pulling Capacity
- Zinc Plated Heavy Gauge Steel Construction
- Smooth-Action, Single Speed Ratcheting Crank with 4:1 Gear Ratio Generates Extra Pulling Power with Less Effort
- Ideal for Trailering/Loading Applications: Boats, Personal Watercraft, Lawn Equipment, Etc.
- Extra Long 9" Handle for Easier Operation
- Comfortable Handle Grip Reduces Fatigue
- 3-Position Locking Pawl Allows Forward and Reverse Ratcheting Action
- Drop Forged Safety Catch Hooks

| Item # | Cable Size | Cable Style |
|--------|-------------|-------------|
| 5552 | 3/16" x 65' | Steel Cable |
| 5553 | 2" x 33' | Poly Strap |

| Item | Description | Packaging | Cs | In |
|------|-----------------------------|-----------|----|----|
| 5552 | 1200-lb. Hand Winch (Cable) | COLOR BOX | 6 | 1 |
| 5553 | 1200-lb. Hand Winch (Strap) | COLOR BOX | 6 | 1 |



Hitch Balls

- Drop Forged Carbon Steel Construction
- Durable Chrome Plated Finish Resists Rust and Corrosion
- Precision-Machined Bolt with Lock Washer and Nut
- Fits Standard Hitch Coupler

| Item # | Ball Diameter | Bolt Diameter | Bolt Length | Towing Capacity |
|--------|---------------|---------------|-------------|-----------------|
| 6069 | 1-7/8" | 1" | 2-1/2" | 2000 Lbs. |
| 6070 | 1-7/8" | 3/4" | 1-3/4" | 2000 Lbs. |
| 6072 | 1-7/8" | 3/4" | 2-1/2" | 2000 Lbs. |
| 6075 | 2" | 3/4" | 1-3/4" | 3500 Lbs. |
| 6077 | 2" | 3/4" | 2-1/2" | 3500 Lbs. |
| 6078 | 2" | 1" | 2-1/2" | 5000 Lbs. |
| 6080 | 2-5/16" | 1" | 2-1/2" | 5000 Lbs. |

| Item | Description | Packaging | Cs | In |
|------|--------------------|------------------------|----|----|
| 6069 | 1-7/8" Hitch Ball | PLASTIC HANG TAB/LABEL | 24 | 1 |
| 6070 | 1-7/8" Hitch Ball | PLASTIC HANG TAB/LABEL | 24 | 1 |
| 6072 | 1-7/8" Hitch Ball | PLASTIC HANG TAB/LABEL | 24 | 1 |
| 6075 | 2" Hitch Ball | PLASTIC HANG TAB/LABEL | 24 | 1 |
| 6077 | 2" Hitch Ball | PLASTIC HANG TAB/LABEL | 24 | 1 |
| 6078 | 2" Hitch Ball | PLASTIC HANG TAB/LABEL | 24 | 1 |
| 6080 | 2-5/16" Hitch Ball | PLASTIC HANG TAB/LABEL | 15 | 1 |

Hitch Ball Coupler

- Drop Forged, Heat Treated Flanged Steel Construction
- Sturdy, Riveted Tongue Lock with Spring Release
- Use with Industrial, Commercial, Utility Agricultural, and Recreational Equipment

| Item # | Hitch Ball Dia. | Tongue Width | Class | Towing Capacity |
|--------|-----------------|--------------|-------|-----------------|
| 6084 | 1-7/8" | 2-1/2" | I | 2,000 LBS |
| 6086 | 2" | 2-1/2" | II | 3,500 LBS |
| 6087 | 2" | 3" | II | 3,500 LBS |
| 6088 | 2" | 2" | II | 3,500 LBS |

| Item | Description | Packaging | Cs | In |
|------|------------------------------------|------------------|----|----|
| 6084 | 1-7/8" x 2-1/2" Hitch Ball Coupler | BULK/COLOR LABEL | 12 | 1 |
| 6086 | 2" x 2-1/2" Hitch Ball Coupler | BULK/COLOR LABEL | 12 | 1 |
| 6087 | 2" x 3" Hitch Ball Coupler | BULK/COLOR LABEL | 12 | 1 |
| 6088 | 2" x 2" Hitch Ball Coupler | BULK/COLOR LABEL | 12 | 1 |

Trailer Jacks

6081

- Adjusts Trailer Tongue Height for Easy Hitching/Unhitching
- Supports Parked or Stored Trailers
- Rugged All-Steel Construction
- Enamel and Zinc-Plated Finish Resists Weather and Corrosion
- Quick-Release, Spring-Return Pin Locks Jack in Vertical and 90° Positions
- 3/16" Swivel Mounting Plate Welds Directly to Trailer Tongue

6083

- Adjusts Trailer Tongue Height for Easy Hitching/Unhitching
- Provides Support and Safe, Easy Moving of Parked or Stored Trailers
- Rugged All-Steel Construction
- Zinc-Plated Finish Resists Weather and Corrosion
- Quick-Release, Spring-Return Pin Locks Jack in Vertical and 90° Positions
- Heavy-Duty 360° Swivel Caster
- 3/16", 4-Bolt Swivel Mounting Plate
- Includes All Mounting Hardware

| Item # | Max. Lift Height | Min. Height | Lift Range | Capacity |
|--------|------------------|-------------|------------|----------|
| 6081 | 23-1/2" | 13-1/4" | 10-1/4" | 2000 LBS |
| 6083 | 21" | 12" | 9" | 1000 LBS |

| Item | Description | Packaging | Cs | In |
|------|-----------------------|-----------|----|----|
| 6081 | 2000-lb. Trailer Jack | COLOR BOX | 4 | 1 |
| 6083 | 1000-lb. Trailer Jack | COLOR BOX | 4 | 1 |



6081



6083

14' x 3/4" Poly Tow Rope

- Rugged, Lightweight, Braided Poly Rope
- Weather-Resistant Polypropylene / Polyethylene Material will not Mildew, Rot, or Shrink
- Forged and Heat-Treated Carbon Steel Safety Catch Hooks
- End-Guards Protect Rope and Prevent Scratching Damage to Attachment Point
- Ideal Roadside Emergency Tow Rope - Lighter and Easier to Use than Chains
- 2,000 lb. Working Load Limit
- 6,000 lb. Maximum Breaking Strength



| Item | Description | Packaging | Cs | In |
|------|--------------------------|-----------------------|----|----|
| 6000 | 14' x 3/4" Poly Tow Rope | SEALED BLISTER - FULL | 20 | 10 |

Flat Tow Straps

- Non-Stretching Woven Polyester Construction Performs Better than Nylon, Applying a Safer, More Consistent Pulling Force
- Weather-Resistant Strap will not Mildew, Rot, or Shrink
- Forged and Heat-Treated Carbon Steel Safety Catch Hooks
- End Guards Protect Strap and Prevent Scratching Damage to Attachment Point

| Item # | Strap Length | Strap Width | Towing Capacity |
|--------|--------------|-------------|-----------------|
| 6005 | 14' | 2" | 6,000 Lbs. |
| 6015 | 20' | 2-1/4" | 10,000 Lbs. |



| Item | Description | Packaging | Cs | In |
|------|-----------------------------|-----------------------|----|----|
| 6005 | 14' x 2" Flat Tow Strap | SEALED BLISTER - FULL | 20 | 10 |
| 6015 | 20' x 2-1/4" Flat Tow Strap | SEALED BLISTER - FULL | 10 | 1 |

Heavy Duty Recovery Straps

- Abrasion and Weather-Resistant Polyester Web Strap
- Looped Ends for Maximum Strength and Versatility

| Item # | Size | Working Load Limit | Max. Break Strength |
|--------|----------|--------------------|---------------------|
| 6225 | 30' x 4" | 6,600 Lbs. | 20,000 Lbs. |
| 62251 | 30' x 3" | 5,400 Lbs. | 16,200 Lbs. |

| Item | Description | Packaging | Cs | In |
|-------|-------------------------|-------------------|----|----|
| 6225 | 30' x 4" Recovery Strap | 4-PC. DISPLAY BOX | 8 | 4 |
| 62251 | 30' x 3" Recovery Strap | 5-PC. DISPLAY BOX | 10 | 5 |





2600 lb. Load Binder

- 9" Cast Steel I-Beam Handle
- Forged Steel Hooks
- Weather-Resistant Baked Enamel Finish
- Applies High Tension with Less Effort
- Use with 1/4" - 5/16" Chain Size
- 2,600 lbs. Working Load Limit
- 7,800 lbs. Maximum Breaking Strength

| Item | Description | Packaging | Cs | In |
|------|----------------------|-----------|----|----|
| 5534 | 2600 lb. Load Binder | TIE CARD | 12 | 1 |



5400 lb. Load Binder

- 13" Cast Steel I-Beam Handle
- Forged Steel Hooks
- Weather-Resistant Baked Enamel Finish
- Applies High Tension with Less Effort
- Use with 5/16" - 3/8" Chain Size
- 5,400 lbs. Working Load Limit
- 19,000 lbs. Maximum Breaking Strength

| Item | Description | Packaging | Cs | In |
|------|----------------------|-----------|----|----|
| 5535 | 5400 lb. Load Binder | TIE CARD | 6 | 1 |

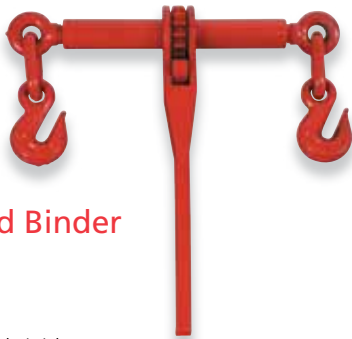

5400 lb. Ratchet Load Binder

- 13" Cast Steel I-Beam Handle
- 15-Tooth, Single Pawl Ratchet
- Forged Steel Hooks
- Weather-Resistant Baked Enamel Finish
- Applies High Tension with Less Effort
- Use with 5/16" - 3/8" Chain Size
- 5,400 lbs. Working Load Limit
- 19,000 lbs. Maximum Breaking Strength

| Item | Description | Packaging | Cs | In |
|------|------------------------------|-----------|----|----|
| 5536 | 5400 lb. Ratchet Load Binder | TIE CARD | 4 | 2 |



9200 lb. Load Binder

- 15" Cast Steel I-Beam Handle
- Forged Steel Hooks
- Weather-Resistant Baked Enamel Finish
- Applies High Tension with Less Effort
- Use with 3/8" - 1/2" Chain Size
- 9,200 lbs. Working Load Limit
- 28,000 lbs. Maximum Breaking Strength

| Item | Description | Packaging | Cs | In |
|------|----------------------|-----------|----|----|
| 5538 | 9200 lb. Load Binder | TIE CARD | 4 | 1 |



62241

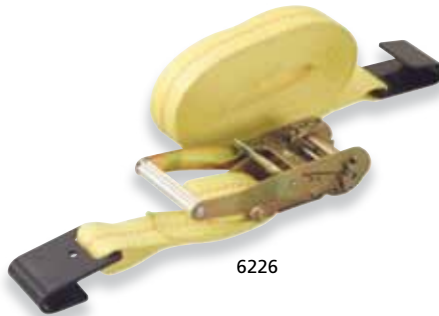

6226

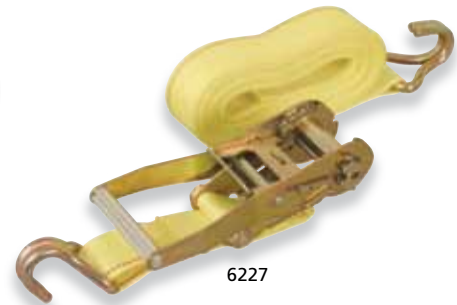

6227

Heavy Duty Ratchet Tie Downs

- Abrasion and Weather-Resistant Polyester Web Strap
- Heat Treated Steel "J"-Hooks
- Dual-Gear Ratchet Applies More Tension with Less Effort
- Quick-Release Dual Pawls Stay Locked and Maintain Tension During Transit
- Meets DOT and CHP Standards

| Item | Description | Packaging | Cs | In |
|-------|---------------------------|-------------------|----|----|
| 62241 | 25' x 2" Ratchet Tie Down | 3-PC. DISPLAY BOX | 6 | 3 |
| 6226 | 30' x 2" Ratchet Tie Down | 3-PC. DISPLAY BOX | 6 | 3 |
| 6227 | 30' x 2" Ratchet Tie Down | 3-PC. DISPLAY BOX | 6 | 3 |

| Item # | Size | Hook Style | Working Load Limit | Max. Break Strength |
|--------|----------|------------|--------------------|---------------------|
| 62241 | 25' x 2" | "J"-Hook | 1,650 Lbs. | 5,000 Lbs. |
| 6226 | 30' x 2" | Flat Hook | 3,333 Lbs. | 10,000 Lbs. |
| 6227 | 30' x 2" | "J"-Hook | 3,333 Lbs. | 10,000 Lbs. |



15' x 1" Premium Ratchet Tie Down Sets

- Weather-Resistant, Woven Polyester Strap
- Dual-Gear Ratchet with Cushioned, Non-Slip Handle Grip Applies More Tension with Less Effort
- One-Touch, Quick-Release Dual Pawls Stay Locked and Maintain Tension During Transit
- Steel "S"-Hooks are Double-Vinyl Coated to Prevent Scratches
- Use to Secure Cargo on Trucks and Trailers
- 500 lb. Working Load Limit
- 1,500 lb. Maximum Breaking Strength

| Item | Description | Packaging | Cs | In |
|------|--|-------------------------|----|----|
| 6220 | 2-pc. 15' x 1" Premium Ratchet Tie Downs | PLASTIC HANG RACK/LABEL | 12 | 4 |
| 6223 | 4-pc. 15' x 1" Premium Ratchet Tie Downs | PLASTIC HANG RACK/LABEL | 12 | 4 |



15' x 1" Ratchet Tie Down Sets

- Weather-Resistant, Woven Polypropylene Strap
- Dual-Gear Ratchet Applies More Tension with Less Effort
- Quick-Release Dual Pawls Stay Locked and Maintain Tension During Transit
- Steel "S"-Hooks are Double-Vinyl Coated to Prevent Scratches
- Use to Secure Cargo on Trucks and Trailers
- 333 lb. Working Load Limit
- 1,000 lb. Maximum Breaking Strength

| Item | Description | Packaging | Cs | In |
|------|----------------------------------|-------------------------|----|----|
| 6218 | 2-pc. 15' x 1" Ratchet Tie Downs | PLASTIC HANG RACK/LABEL | 12 | 4 |
| 6219 | 4-pc. 15' x 1" Ratchet Tie Downs | PLASTIC HANG RACK/LABEL | 8 | 4 |



5' Cam Buckle Tie Down

- Weather-Resistant, Woven Polyester Strap
- Rugged, Quick-Release, Auto-Locking Cam Buckle
- Hardened, Corrosion-Resistant Steel J-Hooks
- Use to Secure Luggage, Back Packs, and other Light Cargo
- 400 lb. Working Load Limit

| Item | Description | Packaging | Cs | In |
|------|------------------------|-----------------------|----|----|
| 6215 | 5' Cam Buckle Tie Down | SEALED BLISTER - FULL | 72 | 6 |



Cam Buckle Tie Downs

- Weather-Resistant, Woven Polypropylene Strap
- Rugged, Quick-Release, Auto-Locking Cam Buckle
- Steel "S"-Hooks are Double-Vinyl Coated to Prevent Scratches
- Use to Secure Cargo on Trucks and Trailers
- 333 lb. Working Load Limit
- 1000 lb. Maximum Breaking Strength

| Item | Description | Packaging | Cs | In |
|------|--------------------------------------|-----------------------|----|----|
| 6214 | 6' x 7/8" Cam Buckle Tie Down | SLIDE BLISTER CARD | 72 | 6 |
| 6216 | 2-pc. 6' x 7/8" Cam Buckle Tie Downs | SEALED BLISTER - FULL | 24 | 4 |
| 6217 | 4-pc. 6' x 7/8" Cam Buckle Tie Downs | SEALED BLISTER - FULL | 12 | 4 |

15' x 1" Ratchet Tie Downs

- Weather-Resistant, Woven Polypropylene Strap
- Dual-Gear Ratchet Applies More Tension with Less Effort
- Quick-Release Dual Pawls Stay Locked and Maintain Tension During Transit
- Steel "S"-Hooks are Double-Vinyl Coated to Prevent Scratches
- Use to Secure Cargo on Trucks and Trailers
- 333 lb. Working Load Limit
- 1000 lb. Maximum Breaking Strength

| Item | Description | Packaging | Cs | In |
|------|----------------------------------|-----------------------|----|----|
| 6221 | 15' x 1" Ratchet Tie Down | SLIDE BLISTER CARD | 24 | 6 |
| 6222 | 4-pc. 15' x 1" Ratchet Tie Downs | SEALED BLISTER - FULL | 8 | 4 |

22' x 2" Ratchet Tie Down

- Weather-Resistant, Woven Polypropylene Strap
- Dual-Gear Ratchet Applies More Tension with Less Effort
- Quick-Release Dual Pawls Stay Locked and Maintain Tension During Transit
- Steel "S"-Hooks are Double-Vinyl Coated to Prevent Scratches
- Use to Secure Cargo on Trucks and Trailers
- 833 lb. Working Load Limit
- 2,500 lb. Maximum Breaking Strength

| Item | Description | Packaging | Cs | In |
|------|---------------------------|-----------------------|----|----|
| 6224 | 22' x 2" Ratchet Tie Down | SEALED BLISTER - FULL | 16 | 4 |





5' Light Duty Cargo Strap

- Weather Resistant Woven Polypropylene Strap
- Rugged Nylon Quick-Release Buckle
- Use to Secure Luggage, Back Packs, and other Light Cargo
- 60 lb. Capacity

| Item | Description | Packaging | Cs | In |
|------|---------------------------|-----------------------|----|----|
| 6213 | 5' Light Duty Cargo Strap | SEALED BLISTER - FULL | 72 | 6 |

EPDM Rubber Tie Downs

- Strong, Weather-Resistant Natural and Synthetic Rubber Blend
- Reinforced Molded Hook Inserts
- Galvanized Steel "S"-Hooks
- Multi-Purpose Tie Down for Tarps, Cars, Trucks, and Trailers

- MINIMUM ORDER QUANTITY: 10-PC. POLYBAG



| Item | Description | Packaging | Cs | In |
|------|--------------------------|------------------|-----|----|
| 6190 | 10" EPDM Rubber Tie Down | BULK/COLOR LABEL | 200 | 10 |
| 6195 | 15" EPDM Rubber Tie Down | BULK/COLOR LABEL | 100 | 10 |
| 6200 | 21" EPDM Rubber Tie Down | BULK/COLOR LABEL | 100 | 10 |
| 6205 | 31" EPDM Rubber Tie Down | BULK/COLOR LABEL | 100 | 10 |
| 6210 | 41" EPDM Rubber Tie Down | BULK/COLOR LABEL | 100 | 10 |

2-pc. Truck Bed Anchor Points

- Solid, Forged Steel Anchors for Extra Strength
- Weather-Resistant Chrome Plated Finish
- Soft Rubber Gasket Prevents Damage to Vehicle Finish and Seals Tight to Keep Water Out
- Strong Anchor Points for Connecting Straps, Tie Downs, and Tarps to Secure and Cover Cargo
- Universal Design for Easy, Non-Permanent Installation in any Truck Bed with Stake Pockets

Specifications:

- Eye Diameter: 7/8"
- Base Plate: 2-1/8" x 2-1/2"
- Mounting Stud: 3/8" x 2-1/4" Length, 2-7/8" Wing Spread



| Item | Description | Packaging | Cs | In |
|------|-------------------------------|--------------------|----|----|
| 6228 | 2-pc. Truck Bed Anchor Points | SLIDE BLISTER CARD | 24 | 6 |

Bungee Cords

- Elastic Design Provides Constant Tension
- Vinyl Coated Steel Hooks and Woven Polyester Strap Cover will not Mar Finish
- Color-Coded Sizes
- Use for Securing Loads on Cars, Trucks, Trailers, Bikes, Motorcycles, and RVs

- | | | |
|--|---|--|
| <p>6229</p> <ul style="list-style-type: none"> • 4-pc. 8" Bungee • 2-pc. 18" Bungee • 2-pc. 24" Bungee • 2-pc. 30" Bungee • 2-pc. 36" Bungee | <p>6230</p> <ul style="list-style-type: none"> • 2-pc. 12" Bungee • 2-pc. 18" Bungee • 2-pc. 24" Bungee | <p>6231</p> <ul style="list-style-type: none"> • 4-pc. 10" Mini Bungee |
|--|---|--|

| Item | Description | Packaging | Cs | In |
|------|--------------------------------|-------------------|-----|----|
| 6229 | 12-pc. Bungee Cord Set | POLYBAG/HANG CARD | 36 | 6 |
| 6230 | 6-pc. Bungee Cord Set | POLYBAG/HANG CARD | 72 | 12 |
| 6231 | 4-pc. 10" Mini Bungee Cord Set | POLYBAG/HANG CARD | 240 | 12 |



Heavy Duty Bungee Cords

- Heavy Duty 1/2" Diameter Elastic Strap Provides Constant Tension to Keep Cargo in Place
- Weather-Resistant Brass Plated Spring Steel Hooks and Woven Polyester Strap Cover
- Quickly Secures Tarps and Light Cargo on Trucks, Trailers, Vans, and SUVs
- MINIMUM ORDER QUANTITY: 10-PC. POLYBAG

| Item | Description | Packaging | Cs | In |
|------|----------------------------|------------------|-----|----|
| 6246 | 18" Heavy Duty Bungee Cord | BULK/COLOR LABEL | 100 | 10 |
| 6247 | 24" Heavy Duty Bungee Cord | BULK/COLOR LABEL | 100 | 10 |
| 6248 | 32" Heavy Duty Bungee Cord | BULK/COLOR LABEL | 100 | 10 |
| 6249 | 48" Heavy Duty Bungee Cord | BULK/COLOR LABEL | 100 | 10 |
| 6250 | 64" Heavy Duty Bungee Cord | BULK/COLOR LABEL | 100 | 10 |
| 6251 | 72" Heavy Duty Bungee Cord | BULK/COLOR LABEL | 100 | 10 |



3-Pc. Heavy Duty Bungee Cord Set

- Heavy Duty 1/2" Diameter Elastic Strap Provides Constant Tension to Keep Cargo in Place
- Weather-Resistant Brass Plated Spring Steel Hooks and Woven Polyester Strap Cover
- Quickly Secures Tarps and Light Cargo on Trucks, Trailers, Vans, and SUVs
- 1-pc. 24" Bungee Strap (Blue)
- 1-pc. 36" Bungee Strap (Red)
- 1-pc. 48" Bungee Strap (White)

| Item | Description | Packaging | Cs | In |
|------|----------------------------------|-------------------|----|----|
| 6252 | 3-pc. Heavy Duty Bungee Cord Set | POLYBAG/HANG CARD | 40 | 5 |



Standard Duty Tarps

BLUE

| Item | Description | Packaging | Cs | In |
|------|---------------------|---------------------|----|----|
| 6289 | 6' x 8' Blue Tarp | POLYBAG/COLOR LABEL | 40 | 1 |
| 6294 | 8' x 10' Blue Tarp | POLYBAG/COLOR LABEL | 25 | 1 |
| 6314 | 10' x 12' Blue Tarp | POLYBAG/COLOR LABEL | 18 | 1 |
| 6324 | 10' x 20' Blue Tarp | POLYBAG/COLOR LABEL | 10 | 1 |
| 6329 | 12' x 16' Blue Tarp | POLYBAG/COLOR LABEL | 12 | 1 |
| 6349 | 16' x 20' Blue Tarp | POLYBAG/COLOR LABEL | 8 | 1 |
| 6374 | 20' x 20' Blue Tarp | POLYBAG/COLOR LABEL | 5 | 1 |

STANDARD DUTY TARP CONSTRUCTION

- Three-Layer Construction of Specially Reinforced, Laminated, High-Density Polyethylene Fabric
- Water, Rot, and Mildew-Resistant
- Crack-Resistant to -20° F

- Top Lamination - Water Resistant PE Coating

- 8 x 10 Cross Weave

- Bottom Lamination - Water Resistant PE Coating

- Poly Roping Sewn into Hem All Around for Extra Strength

- Aluminum Grommets every 36" Around Hem and at Every Corner

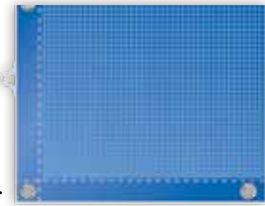
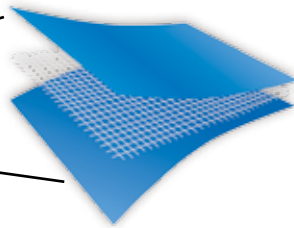

SILVER

| Item | Description | Packaging | Cs | In |
|------|-------------------------------|---------------------|----|----|
| 6270 | 4' x 6' Silver Tarp | POLYBAG/COLOR LABEL | 60 | 1 |
| 6285 | 5' x 7' Silver Tarp | POLYBAG/COLOR LABEL | 50 | 1 |
| 6290 | 6' x 8' Silver Tarp | POLYBAG/COLOR LABEL | 40 | 1 |
| 6295 | 8' x 10' Silver Tarp | POLYBAG/COLOR LABEL | 25 | 1 |
| 6300 | 9' x 12' Silver Tarp | POLYBAG/COLOR LABEL | 20 | 1 |
| 6305 | 9' x 16' Silver Tarp | POLYBAG/COLOR LABEL | 18 | 1 |
| 6310 | 10' x 10' Silver Tarp | POLYBAG/COLOR LABEL | 20 | 1 |
| 6315 | 10' x 12' Silver Tarp | POLYBAG/COLOR LABEL | 18 | 1 |
| 6320 | 10' x 15' Silver Tarp | POLYBAG/COLOR LABEL | 16 | 1 |
| 6325 | 10' x 20' Silver Tarp | POLYBAG/COLOR LABEL | 10 | 1 |
| 6328 | 12' x 12' Silver Tarp | POLYBAG/COLOR LABEL | 16 | 1 |
| 6330 | 12' x 16' Silver Tarp | POLYBAG/COLOR LABEL | 12 | 1 |
| 6335 | 12' x 20' Silver Tarp | POLYBAG/COLOR LABEL | 10 | 1 |
| 6340 | 12' x 24' Silver Tarp | POLYBAG/COLOR LABEL | 10 | 1 |
| 6342 | 14' x 18' Silver Tarp | POLYBAG/COLOR LABEL | 10 | 1 |
| 6345 | 15' x 30' Silver Tarp | POLYBAG/COLOR LABEL | 5 | 1 |
| 6350 | 16' x 20' Silver Tarp | POLYBAG/COLOR LABEL | 8 | 1 |
| 6355 | 16' x 32' Silver Tarp | POLYBAG/COLOR LABEL | 4 | 1 |
| 6360 | 18' x 24' Silver Tarp | POLYBAG/COLOR LABEL | 5 | 1 |
| 6370 | 18' x 36' Silver Tarp | POLYBAG/COLOR LABEL | 3 | 1 |
| 6375 | 20' x 20' Silver Tarp | POLYBAG/COLOR LABEL | 5 | 1 |
| 6380 | 20' x 30' Silver Tarp | POLYBAG/COLOR LABEL | 3 | 1 |
| 6385 | 20' x 40' Silver Tarp | POLYBAG/COLOR LABEL | 2 | 1 |
| 6390 | 20' x 50' Silver Tarp | POLYBAG/COLOR LABEL | 2 | 1 |
| 6392 | 24' x 24' Silver Tarp - Round | POLYBAG/COLOR LABEL | 2 | 1 |
| 6395 | 26' x 40' Silver Tarp | POLYBAG/COLOR LABEL | 2 | 1 |
| 6400 | 26' x 48' Silver Tarp | POLYBAG/COLOR LABEL | 2 | 1 |
| 6405 | 29' x 29' Silver Tarp - Round | POLYBAG/COLOR LABEL | 1 | 1 |
| 6406 | 30' x 30' Silver Tarp | POLYBAG/COLOR LABEL | 2 | 1 |
| 6408 | 30' x 40' Silver Tarp | POLYBAG/COLOR LABEL | 2 | 1 |
| 6410 | 30' x 50' Silver Tarp | POLYBAG/COLOR LABEL | 1 | 1 |
| 6415 | 30' x 60' Silver Tarp | POLYBAG/COLOR LABEL | 1 | 1 |
| 6420 | 33' x 33' Silver Tarp - Round | POLYBAG/COLOR LABEL | 1 | 1 |
| 6425 | 40' x 60' Silver Tarp | POLYBAG/COLOR LABEL | 1 | 1 |

GREEN

BROWN

| Item | Description | Packaging | Cs | In |
|------|----------------------------|----------------------|----|----|
| 6280 | 4' x 18' Green/Brown Tarp | POLYBAG-COLOR SLEEVE | 25 | 1 |
| 6286 | 6' x 8' Green/Brown Tarp | POLYBAG-COLOR SLEEVE | 40 | 1 |
| 6291 | 6' x 24' Green/Brown Tarp | POLYBAG-COLOR SLEEVE | 16 | 1 |
| 6296 | 8' x 10' Green/Brown Tarp | POLYBAG-COLOR SLEEVE | 25 | 1 |
| 6301 | 9' x 12' Green/Brown Tarp | POLYBAG-COLOR SLEEVE | 20 | 1 |
| 6316 | 10' x 12' Green/Brown Tarp | POLYBAG-COLOR SLEEVE | 18 | 1 |
| 6326 | 10' x 20' Green/Brown Tarp | POLYBAG-COLOR SLEEVE | 20 | 1 |
| 6331 | 12' x 16' Green/Brown Tarp | POLYBAG-COLOR SLEEVE | 12 | 1 |
| 6351 | 16' x 20' Green/Brown Tarp | POLYBAG-COLOR SLEEVE | 8 | 1 |
| 6376 | 20' x 20' Green/Brown Tarp | POLYBAG-COLOR SLEEVE | 5 | 1 |
| 6381 | 20' x 30' Green/Brown Tarp | POLYBAG-COLOR SLEEVE | 3 | 1 |
| 6386 | 20' x 40' Green/Brown Tarp | POLYBAG-COLOR SLEEVE | 2 | 1 |

CAMOUFLAGE

| Item | Description | Packaging | Cs | In |
|------|---------------------------|----------------------|----|----|
| 6438 | 4' x 18' Camouflage Tarp | POLYBAG-COLOR SLEEVE | 25 | 1 |
| 6439 | 6' x 24' Camouflage Tarp | POLYBAG-COLOR SLEEVE | 16 | 1 |
| 6440 | 6' x 8' Camouflage Tarp | POLYBAG-COLOR SLEEVE | 40 | 1 |
| 6441 | 8' x 10' Camouflage Tarp | POLYBAG-COLOR SLEEVE | 25 | 1 |
| 6442 | 9' x 12' Camouflage Tarp | POLYBAG-COLOR SLEEVE | 20 | 1 |
| 6443 | 10' x 12' Camouflage Tarp | POLYBAG-COLOR SLEEVE | 18 | 1 |
| 6444 | 10' x 20' Camouflage Tarp | POLYBAG-COLOR SLEEVE | 20 | 1 |
| 6445 | 12' x 16' Camouflage Tarp | POLYBAG-COLOR SLEEVE | 12 | 1 |
| 6446 | 16' x 20' Camouflage Tarp | POLYBAG-COLOR SLEEVE | 8 | 1 |

Double Duty Tarps

| SILVER | | BLACK | |
|--------|---|---------------------|-------|
| Item | Description | Packaging | Cs In |
| 6292 | 6' x 8' Double Duty Tarp - Silver/Black | POLYBAG/COLOR LABEL | 24 1 |
| 6297 | 8' x 10' Double Duty Tarp - Silver/Black | POLYBAG/COLOR LABEL | 16 1 |
| 6312 | 10' x 10' Double Duty Tarp - Silver/Black | POLYBAG/COLOR LABEL | 12 1 |
| 6317 | 10' x 12' Double Duty Tarp - Silver/Black | POLYBAG/COLOR LABEL | 10 1 |
| 6323 | 10' x 20' Double Duty Tarp - Silver/Black | POLYBAG/COLOR LABEL | 6 1 |
| 6332 | 12' x 16' Double Duty Tarp - Silver/Black | POLYBAG/COLOR LABEL | 6 1 |
| 6337 | 12' x 20' Double Duty Tarp - Silver/Black | POLYBAG/COLOR LABEL | 5 1 |
| 6338 | 12' x 24' Double Duty Tarp - Silver/Black | POLYBAG/COLOR LABEL | 4 1 |
| 6347 | 15' x 30' Double Duty Tarp - Silver/Black | POLYBAG/COLOR LABEL | 3 1 |
| 6352 | 16' x 20' Double Duty Tarp - Silver/Black | POLYBAG/COLOR LABEL | 4 1 |
| 6362 | 18' x 24' Double Duty Tarp - Silver/Black | POLYBAG/COLOR LABEL | 3 1 |
| 6377 | 20' x 20' Double Duty Tarp - Silver/Black | POLYBAG/COLOR LABEL | 2 1 |
| 6382 | 20' x 30' Double Duty Tarp - Silver/Black | POLYBAG/COLOR LABEL | 2 1 |
| 6387 | 20' x 40' Double Duty Tarp - Silver/Black | POLYBAG/COLOR LABEL | 1 1 |
| 6397 | 26' x 40' Double Duty Tarp - Silver/Black | POLYBAG/COLOR LABEL | 1 1 |
| 6402 | 30' x 40' Double Duty Tarp - Silver/Black | POLYBAG/COLOR LABEL | 1 1 |
| 6412 | 30' x 50' Double Duty Tarp - Silver/Black | POLYBAG/COLOR LABEL | 1 1 |
| 6427 | 40' x 60' Double Duty Tarp - Silver/Black | POLYBAG/COLOR LABEL | 1 1 |



DOUBLE DUTY TARP CONSTRUCTION

- Three-Layer Construction of Specially Reinforced, Laminated, High-Density Polyethylene Fabric
- Water, Rot, and Mildew-Resistant
- Crack-Resistant to -20° F
- Silver on One Side, Black on the Other - Silver Side Reflects Light and Heat
- UV-Resistant Treated Fabric

- Top Lamination - Water Resistant PE Coating

- 14 x 14 Cross Weave (200% Denser than Standard Grade)

- Bottom Lamination - Water Resistant PE Coating

- Brass-Coated Grommets every 18" Around Hem and at Every Corner

- Poly Roping Sewn into Hem All Around for Extra Strength

- Reinforcing Bars at Each Corner

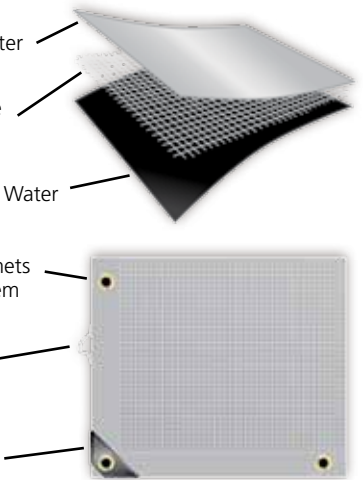

53-pc. 1/2" Grommet Kit

- Standard Size 1/2" Weather-Resistant Brass Plated Grommets
- Heavy Duty Zinc Plated Steel Punches and Anvil
- Save Money by Repairing Tarps, Tents, Awnings, Pool Covers, Canopies, and More
- 1-pc. Anvil
- 1-pc. Hole Punch
- 1-pc. Grommet Crimper Punch
- 50-pc. 1/2" Grommets

| Item | Description | Packaging | Cs | In |
|------|-------------------------|-----------------------|----|----|
| 6430 | 53-pc. 1/2" Grommet Kit | SEALED BLISTER - FULL | 50 | 10 |

13-pc. 3/8" Grommet Kit

- Standard Size 3/8" Weather-Resistant Brass Plated Grommets
- One-Piece Steel Grommet Punch and Anvil Tool
- Save Money by Repairing Tarps, Tents, Awnings, Pool Covers, Canopies, and More
- 12-pc. 3/8" Grommets
- 1-pc. Grommet Tool

| Item | Description | Packaging | Cs | In |
|------|-------------------------|--------------------|----|----|
| 6590 | 13-pc. 3/8" Grommet Kit | SLIDE BLISTER CARD | 72 | 12 |

50-pc. 3/8" Brass Grommets

- Standard Size 3/8" Weather-Resistant Brass Plated Grommets
- Save Money by Repairing Tarps, Tents, Awnings, Pool Covers, Canopies, and More
- 50-pc. 3/8" Grommets

| Item | Description | Packaging | Cs | In |
|------|----------------------------|--------------------|----|----|
| 6595 | 50-pc. 3/8" Brass Grommets | SLIDE BLISTER CARD | 72 | 12 |





3/8" Drive Butterfly Impact Wrench

- Die Cast Aluminum Body
- Compact Housing for Access to Tight Areas
- Forward/Reverse Variable Speed Butterfly Throttle
- Rubber Anti-Scuff Nose Guard
- Built-in Air Regulator
- Maximum Torque: 75 Ft./Lbs.
- Maximum Speed: 10,000 RPM
- Working Air Pressure: 90 PSI
- Average Air Consumption: 2.5 CFM
- Air Inlet: 1/4"
- Minimum Air Hose Size: 3/8"

- 1-pc. Butterfly Impact Wrench
- 2-pc. Replacement Gaskets
- 4-pc. Replacement Valve Seat Seals

| Item | Description | Packaging | Cs | In |
|------|------------------------------------|-----------------------|----|----|
| 4095 | 3/8" Drive Butterfly Impact Wrench | SEALED BLISTER - FULL | 20 | 1 |



3/8" Drive Impact Wrench

- Die Cast Aluminum Body
- Variable Speed Reversible Drive
- Comfortable Pistol Grip Handle with Oversized Trigger
- Ball Bearing Motor
- Built-in Air Regulator
- Maximum Torque: 130 Ft./Lbs.
- Maximum Speed: 12,000 RPM
- Working Air Pressure: 90 PSI
- Average Air Consumption: 3 CFM
- Air Inlet: 1/4"
- Minimum Air Hose Size: 3/8"

- 1-pc. Impact Wrench
- 1-pc. Hex Wrench

| Item | Description | Packaging | Cs | In |
|------|--------------------------|-----------------------|----|----|
| 4100 | 3/8" Drive Impact Wrench | SEALED BLISTER - FULL | 10 | 1 |



1/2" Drive Impact Wrench

- Die Cast Aluminum Body
- Variable Speed Reversible Drive
- Non-Slip Cushioned Pistol Grip Handle with Oversized Trigger
- Ball Bearing Motor
- Maximum Torque: 260 Ft./Lbs.
- Maximum Speed: 6,500 RPM
- Working Air Pressure: 90 PSI
- Average Air Consumption: 4 CFM
- Air Inlet: 1/4"
- Minimum Air Hose Size: 3/8"

- 1-pc. Impact Wrench
- 1-pc. Hex Wrench

| Item | Description | Packaging | Cs | In |
|------|--------------------------|-----------------------|----|----|
| 4105 | 1/2" Drive Impact Wrench | SEALED BLISTER - FULL | 10 | 1 |



1/2" Drive Impact Wrench

- Heavy Duty Die Cast Aluminum Body
- Twin-Hammer Design Delivers up to 400 Ft./Lbs. of Torque
- Variable Speed Reversible Drive
- Non-Slip Cushioned Pistol Grip Handle with Oversized Trigger
- Ball Bearing Motor
- Maximum Torque: 400 Ft./Lbs.
- Maximum Speed: 7,000 RPM
- Working Air Pressure: 90 PSI
- Average Air Consumption: 4 CFM
- Air Inlet: 1/4"
- Minimum Air Hose Size: 3/8"

- 1-pc. Impact Wrench
- 1-pc. Hex Wrench

| Item | Description | Packaging | Cs | In |
|------|--------------------------|-----------------------|----|----|
| 4108 | 1/2" Drive Impact Wrench | SEALED BLISTER - FULL | 10 | 1 |

1/4" Drive Air Ratchet

- Forged Steel Head and Aluminum Body
- Variable Speed Reversible Drive
- Lever-Style Throttle
- Ball Bearing Motor
- Compact Head Reaches into Tight Areas
- Maximum Torque: 25 Ft./Lbs.
- Maximum Speed: 250 RPM
- Working Air Pressure: 90 PSI
- Average Air Consumption: 4 CFM
- Air Inlet: 1/4"
- Minimum Air Hose Size: 3/8"

| Item | Description | Packaging | Cs | In |
|------|------------------------|-----------------------|----|----|
| 4150 | 1/4" Drive Air Ratchet | SEALED BLISTER - FULL | 20 | 1 |



3/8" Drive Air Ratchet

- Forged Steel Head and Aluminum Body
- Variable Speed Reversible Drive
- Lever-Style Throttle
- Non-Slip Cushion Grip Housing
- Ball Bearing Motor
- Compact Head Reaches into Tight Areas
- Maximum Torque: 50 Ft./Lbs.
- Maximum Speed: 160 RPM
- Working Air Pressure: 90 PSI
- Average Air Consumption: 4 CFM
- Air Inlet: 1/4"
- Minimum Air Hose Size: 3/8"

| Item | Description | Packaging | Cs | In |
|------|------------------------|-----------------------|----|----|
| 4155 | 3/8" Drive Air Ratchet | SEALED BLISTER - FULL | 20 | 1 |



1/2" Drive Air Ratchet

- Forged Steel Head and Aluminum Body
- Variable Speed Reversible Drive
- Lever-Style Throttle
- Non-Slip Cushion Grip Housing
- Ball Bearing Motor
- Compact Head Reaches into Tight Areas
- Maximum Torque: 50 Ft./Lbs.
- Maximum Speed: 160 RPM
- Working Air Pressure: 90 PSI
- Average Air Consumption: 4 CFM
- Air Inlet: 1/4"
- Minimum Air Hose Size: 3/8"

| Item | Description | Packaging | Cs | In |
|------|------------------------|-----------------------|----|----|
| 4160 | 1/2" Drive Air Ratchet | SEALED BLISTER - FULL | 20 | 1 |





7-pc. 150mm Air Hammer Set

- Die Cast Aluminum Body
- Variable Speed Drive
- Non-Slip Cushion Grip Handle
- Spring-Type Tool Retainer
- Chrome Molybdenum Steel Chisels

- Blows per Minute: 4500
- Bore: 3/4"
- Stroke: 1-5/8"
- Chisel Shank: .401"
- Working Air Pressure: 90 PSI
- Average Air Consumption: 4 CFM
- Air Inlet: 1/4"
- Minimum Air Hose Size: 3/8"

- 1-pc. Air Hammer
- 1-pc. Tool Retaining Spring
- 1-pc. Male Quick Connector
- 4-pc. 5" Chisels: Flat Chisel, Weld Breaker, Cutting Chisel, and Tapered Punch

| Item | Description | Packaging | Cs | In |
|------|----------------------------|-----------------------|----|----|
| 4185 | 7-pc. 150mm Air Hammer Set | SEALED BLISTER - FULL | 10 | 1 |



7-pc. 190mm Air Hammer Set

- Die Cast Aluminum Body
- Variable Speed Drive
- Non-Slip Cushion Grip Handle
- Spring-Type Tool Retainer
- Chrome Molybdenum Steel Chisels

- Blows per Minute: 3500
- Bore: 11/16"
- Stroke: 2-5/8"
- Chisel Shank: .401"
- Working Air Pressure: 90 PSI
- Average Air Consumption: 4 CFM
- Air Inlet: 1/4"
- Minimum Air Hose Size: 3/8"

- 1-pc. Air Hammer
- 1-pc. Tool Retaining Spring
- 1-pc. Male Quick Connector
- 4-pc. 5" Chisels: Flat Chisel, Weld Breaker, Cutting Chisel, and Tapered Punch

| Item | Description | Packaging | Cs | In |
|------|----------------------------|-----------------------|----|----|
| 4190 | 7-pc. 190mm Air Hammer Set | SEALED BLISTER - FULL | 10 | 1 |



9-pc. Air Chisel Set

- Hardened Chrome Molybdenum Steel
- Precision Machined Tips
- Universal Fit .401" Shank
- Complete with Organizer Storage Pouch

- 4-pc. 5" Chisels: Flat Chisel, Weld Breaker, Cutting Chisel, and Tapered Punch
- 5-pc. 7" Chisels: Rivet Cutter, "V" Cutting Chisel, Half Round Cutting Chisel, Sheet Metal Cutter, Slot Panel Cutter

| Item | Description | Packaging | Cs | In |
|------|----------------------|-----------------------|----|----|
| 4215 | 9-pc. Air Chisel Set | SEALED BLISTER - FULL | 18 | 3 |



3/8" Reversible Air Drill

- Lightweight Aluminum Body
- Rubberized Grip Improves Control and Reduces Fatigue
- Rugged Jacobs® Chuck Grips Drill Bits without Slipping
- Built-in Air Regulator Controls Speed

- Chuck Capacity: 3/8"
- Working Air Pressure: 90 PSI
- Average Air Consumption: 4 CFM
- Air Inlet: 1/4"
- Minimum Air Hose Size: 3/8"

- 1-pc. 3/8" Drill
- 1-pc. Chuck Key

| Item | Description | Packaging | Cs | In |
|------|---------------------------|-----------------------|----|----|
| 4421 | 3/8" Reversible Air Drill | SEALED BLISTER - FULL | 10 | 1 |



1/4" Die Grinder

- Die Cast Aluminum Body
- Rear Exhaust Directs Air Away from Work Piece
- Variable Speed
- Lever-Style Throttle with Lock-Out Safety Switch
- Non-Slip Cushion Grip Housing
- Ball Bearing Motor
- Compact Size for Easy Handling in Tight Spots

- Collet Size: 1/4"
- Maximum Speed: 22,000 RPM
- Working Air Pressure: 90 PSI
- Average Air Consumption: 3.5 CFM
- Air Inlet: 1/4"
- Minimum Air Hose Size: 3/8"

- 1-pc. Die Grinder
- 2-pc. Chuck Wrenches

| Item | Description | Packaging | Cs | In |
|------|------------------|-----------------------|----|----|
| 4255 | 1/4" Die Grinder | SEALED BLISTER - FULL | 25 | 5 |



1/4" Angle Die Grinder

- Die Cast Aluminum Body
- 90° Angled Head Reaches Work in Tight Areas
- Variable Speed
- Lever-Style Throttle with Lock-Out Safety Switch
- Non-Slip Cushion Grip Housing
- Nickel Chrome Molybdenum Gears for Long Service Life

- Collet Size: 1/4"
- Maximum Speed: 20,000 RPM
- Working Air Pressure: 60 PSI
- Average Air Consumption: 6 CFM
- Air Inlet: 1/4"
- Minimum Air Hose Size: 3/8"

- 1-pc. Die Grinder
- 2-pc. Chuck Wrenches

| Item | Description | Packaging | Cs | In |
|------|------------------------|-----------------------|----|----|
| 4260 | 1/4" Angle Die Grinder | SEALED BLISTER - FULL | 30 | 1 |



3" Utility Cut-Off Tool

- Die Cast Aluminum Body
- Rear Exhaust Directs Air Away from Work Piece
- Variable Speed
- Lever-Style Throttle with Lock-Out Safety Switch
- Non-Slip Cushion Grip Housing
- Ball Bearing Motor
- 180-degree Safety Guard

- Maximum Speed: 22,000 RPM
- Working Air Pressure: 90 PSI
- Average Air Consumption: 4 CFM
- Air Inlet: 1/4"
- Minimum Air Hose Size: 3/8"

- 1-pc. Utility Cut-Off Tool
- 1-pc. 3" Cut-Off Wheel
- 1-pc. Hex Key Wrench
- 1-pc. Chuck Wrench

| Item | Description | Packaging | Cs | In |
|------|-------------------------|-----------------------|----|----|
| 4315 | 3" Utility Cut-Off Tool | SEALED BLISTER - FULL | 20 | 1 |



3" x 1/16" Cut-Off Wheels

- Reinforced, Bonded Carbon Construction
- Cuts Steel Rods and Bolts, Sheet Metal, and Muffler Clamps
- Universal Fit for Most Pneumatic Cut-Off Tools
- Diameter: 3"
- Arbor: 3/8"
- Thickness: 1/16"
- Maximum Speed: 20,000 RPM

| Item | Description | Packaging | Cs | In |
|------|---------------------------------|--------------|------|----|
| 4320 | 3" x 1/16" Cut-Off Wheel | BULK/UPC | 1000 | 50 |
| 4325 | 5-pc. 3" Utility Cut-Off Wheels | BLISTER CARD | 144 | 12 |



5" High Speed Sander

- Die Cast Aluminum Body
- Ball Bearing Motor
- Non-Slip Cushion Handle Grip
- Maximum Speed: 18,000 RPM
- Working Air Pressure: 60 PSI
- Average Air Consumption: 5.2 CFM
- Air Inlet: 1/4"
- Minimum Air Hose Size: 3/8"
- 1-pc. High Speed Sander
- 3-pc. Sanding Pads: 3", 4-1/2", 5-1/2"
- 1-pc. Retaining Screw
- 1-pc. Cross Bar Wrench

| Item | Description | Packaging | Cs | In |
|------|----------------------|-----------------------|----|----|
| 4275 | 5" High Speed Sander | SEALED BLISTER - FULL | 10 | 1 |



Dual Piston Straight Line Sander

- Die Cast Aluminum Body
- Variable Speed
- Comfortable Contoured Handles
- Ball Bearing Motor with Dual Drive Pistons
- Sand Paper Size: 2-3/4" x 17-1/2"
- Stroke Length: 1"
- Strokes per Minute: 3000 RPM
- Working Air Pressure: 60 PSI
- Average Air Consumption: 6 CFM
- Air Inlet: 1/4"
- Minimum Air Hose Size: 3/8"

| Item | Description | Packaging | Cs | In |
|------|----------------------------------|-----------|----|----|
| 4305 | Dual Piston Straight Line Sander | COLOR BOX | 6 | 1 |



6" Dual Action Sander

- Die Cast Aluminum Body
- Balanced Ball-Bearing Construction for Quiet, Low-Vibration Operation
- Variable Speed
- Lever-Style Throttle
- Non-Slip Cushion Handle Grip
- Muffler for Quiet Operation
- 1-pc. Dual Action Sander
- 1-pc. 6" Neoprene Sanding Pad
- Spindle Thread Size: 5/16" (24 UNF)
- Maximum Speed: 10,000 RPM
- Working Air Pressure: 90 PSI
- Average Air Consumption: 4 CFM
- Air Inlet: 1/4"
- Minimum Air Hose Size: 3/8"

| Item | Description | Packaging | Cs | In |
|------|-----------------------|-----------------------|----|----|
| 4285 | 6" Dual Action Sander | SEALED BLISTER - FULL | 10 | 1 |



6" Dual Action Sanding Pad

- Firm, Flexible Neoprene Construction
- 6" Diameter Uses Standard Self-Adhesive Sanding Discs
- Maximum Speed: 10,000 RPM
- 5/16" (24 UNF) Spindle Thread
- Fits Most Dual Action Air Sanders

| Item | Description | Packaging | Cs | In |
|------|----------------------------|-------------------|-----|----|
| 4295 | 6" Dual Action Sanding Pad | POLYBAG/HANG CARD | 100 | 10 |



4360



4365



Paint Spray Guns

- Professional-Grade Dual Action External Mix Siphon Feed Spray Gun
- Brass Head with Adjustable Spray Pattern Control
- Precision-Machined Brass Nozzle Provides a Constant, Uniform Finish
- Comfortable Oversized Trigger Reduces Fatigue
- Anti-Drip One-Liter Aluminum Quick Release Paint Cup

- Cup Capacity: 1 Liter
- Air Inlet: 1/4"
- Fluid Inlet: 3/8"
- Minimum Compressor: 1-1/2 HP
- Working Air Pressure: 50-70 PSI
- Average Air Consumption: 8.5-12 CFM

| Item | Description | Packaging | Cs | In |
|------|-----------------|-----------|----|----|
| 4360 | Paint Spray Gun | COLOR BOX | 10 | 1 |
| 4365 | Paint Spray Gun | COLOR BOX | 10 | 1 |

Paint Spray Gun Cup (1 Liter)

- One Liter Capacity
- Aluminum Cup with Quick-Release Cover
- Anti-Drip Siphon Feed
- Fits TEKTON® 4360 and 4365 Spray Guns and Most High Pressure, Siphon Feed Pneumatic Spray Guns

| Item | Description | Packaging | Cs | In |
|------|-------------------------------|-----------|----|----|
| 4370 | Paint Spray Gun Cup (1 Liter) | COLOR BOX | 20 | 1 |

Touch-Up Spray Gun

- Lightweight, Compact Size Designed for Stenciling, Touch-up, and Precise Detail Spraying
- Rugged Cast Aluminum Head
- Precision-Machined External Mix Brass Nozzle
- Fully Adjustable Spray Pattern
- Comfortable Oversized Trigger Reduces Fatigue
- Anti-Drip 1/4 Liter Quick-Release Aluminum Paint Cup

- Cup Capacity: .25 Liter
- Fluid Inlet: 3/8"
- Working Air Pressure: 30-50 PSI
- Average Air Consumption: 4 CFM
- Air Inlet: 1/4"

| Item | Description | Packaging | Cs | In |
|------|--------------------|-----------|----|----|
| 4375 | Touch-Up Spray Gun | COLOR BOX | 20 | 1 |



Touch-Up Paint Cup

- Polished, Cast Aluminum Cup with Anti-Drip Siphon Feed
- 1/4 Liter Capacity
- Quick Release Cover, Forged Air Cap
- Fits TEKTON® 4375 Touch-Up Spray Gun and Most Touch-Up Paint Spray Guns

| Item | Description | Packaging | Cs | In |
|------|--------------------|-----------|----|----|
| 4380 | Touch-Up Paint Cup | COLOR BOX | 70 | 1 |





Engine Cleaning Gun

- All-Purpose Spray Cleaning Gun Degreases Engine Compartments and Machinery, Removes Road Grime from Wheels and Tires, Cleans Hard-to-Reach Areas, and Much More
- High-Pressure Nozzle Delivers Heavy Duty Cleaning Power
- Extra Long 9" Wand Reaches into Tight Spaces
- Variable-Pressure Trigger Controls Spray Volume
- Adjustable Siphon Feed Control
- Sprays Engine Cleaners, Degreasers, Detergents, and Solvents for Maximum Cleaning Power
- 4' Siphon Hose with Built-in Filter Screen

Specifications:

- Air Inlet: 1/4" NPT
- Working Air Pressure: 90 PSI
- Average Air Consumption: 5 CFM
- Minimum Air Compressor: 1 HP (delivering constant 5 CFM)
- 1-pc. High-Pressure Spray Gun
- 1-pc. 4-ft. Siphon Hose

| Item | Description | Packaging | Cs | In |
|------|---------------------|--------------------|----|----|
| 4510 | Engine Cleaning Gun | SLIDE BLISTER CARD | 24 | 6 |



17-pc. Air Tool Accessory Kit

- Complete Assortment of Clean-up and Inflation Tools, Adapters, and Air Tool Connectors
- Universal Fit 1/4" NPT
- 1-pc. Blow Gun
- 1-pc. 50 PSI Tire Gauge
- 1-pc. Dual Tire Chuck
- 1-pc. Precision Nozzle
- 1-pc. Safety Nozzle/Tip Adapter
- 1-pc. Power Wire Brush
- 2-pc. Female Quick Connect Plugs
- 2-pc. Male Quick Connect Plugs
- 2-pc. Quick Connect Couplers
- 2-pc. Male Couplers
- 1-pc. Female Coupler
- 2-pc. Inflation Needles

| Item | Description | Packaging | Cs | In |
|-------|-------------------------------|-----------------------|----|----|
| 47261 | 17-pc. Air Tool Accessory Kit | SEALED BLISTER - FULL | 24 | 4 |



4520

4530

Air Sandblasting Kits

- Compact, Lightweight, Siphon-Type Sandblaster
- Multi-Purpose Design for Sandblasting and High-Pressure Liquid or Air Cleaning of Parts and Surfaces
- Aspirator System Assures Uninterrupted Flow of Blasting Material
- Comfortable Cast Aluminum Pistol Grip Handle with Oversized Trigger
- Use with Most Common Abrasives Including Aluminum Oxide, Silicon Carbide, and Steel Grit

Specifications:

- Working Air Pressure: 60-120 PSI
- Maximum Air Pressure: 150 PSI
- Average Air Consumption: 6 CFM
- Air Inlet: 1/4"
- 1-pc. Blaster Gun
- 1-pc. Pickup Tube
- 1-pc. 10' Siphon Hose
- 3-pc. 1/4" Sandblasting Nozzles
- 1-pc. 5/64" Air Jet
- 1-pc. Hex Key

4530

- Quick and Easy Installation
- Replacement Tips for Air Sandblasting Kit (#4520)
- 3-pc. 1/4" Nozzles
- 1-pc. 13/16" Jet
- 1-pc. 1/8" Hex Key Wrench

| Item | Description | Packaging | Cs | In |
|------|--------------------------------|--------------------|-----|----|
| 4520 | 8-pc. Air Sandblasting Kit | SLIDE BLISTER CARD | 10 | 1 |
| 4530 | 5-pc. Air Sandblasting Tip Kit | POLYBAG/HANG CARD | 144 | 12 |



Air Blow Gun

- Rugged Zinc Cast Body with Hanging Storage Hook
- Corrosion-Resistant Chrome Plated Finish
- Comfortable Non-Slip Control Lever
- Clears Dust and Debris from Work Area
- Air Inlet: 1/4" NPT

- 1-pc. Blow Gun
- 1-pc. High Pressure Nozzle
- 1-pc. Safety Nozzle

| Item | Description | Packaging | Cs | In |
|------|--------------|--------------------|----|----|
| 4740 | Air Blow Gun | SLIDE BLISTER CARD | 72 | 12 |



Female Coupler

- Solid Brass Construction
- Precision-Machined for Leak-Proof Operation
- 1/4" NPT (F) x 1/4" NPT (F)

| Item | Description | Packaging | Cs | In |
|------|----------------|--------------------|-----|----|
| 4728 | Female Coupler | SLIDE BLISTER CARD | 288 | 12 |



5-pc. Quick Coupler Set

- Rugged, Zinc-Plated Steel Construction
- Precision Machined for Leak-Proof Operation
- Allows One-Touch Connecting and Disconnecting of Tools and Accessories
- Fittings Rotate to Eliminate Twisted Hoses
- Universal Fit for 1/4" NPT Tools
- 1-pc. Female Quick Coupler
- 1-pc. Female Connector
- 3-pc. Male Connectors

| Item | Description | Packaging | Cs | In |
|------|-------------------------|--------------|----|----|
| 4710 | 5-pc. Quick Coupler Set | BLISTER CARD | 72 | 12 |



5-pc. Quick Coupler Set

- Rugged Solid Brass Construction
- Precision Machined for Leak-Proof Operation
- Allows One-Touch Connecting and Disconnecting of Tools and Accessories
- Fittings Rotate to Eliminate Twisted Hoses
- Universal Fit for 1/4" NPT Tools
- 1-pc. Female Quick Coupler
- 1-pc. Female Connector
- 3-pc. Male Connectors

| Item | Description | Packaging | Cs | In |
|------|-------------------------|--------------------|----|----|
| 4720 | 5-pc. Quick Coupler Set | SLIDE BLISTER CARD | 72 | 12 |



5-pc. Quick Coupler Set

- Rugged Solid Brass Construction
- Precision Machined for Leak-Proof Operation
- Allows One-Touch Connecting and Disconnecting of Tools and Accessories
- Fittings Rotate to Eliminate Twisted Hoses
- Universal Fit for 1/4" NPT Tools
- 1-pc. Female Quick Coupler
- 1-pc. Female Connector
- 2-pc. Male Connectors
- 1-pc. Nipple

| Item | Description | Packaging | Cs | In |
|------|-------------------------|--------------------|----|----|
| 4725 | 5-pc. Quick Coupler Set | SLIDE BLISTER CARD | 72 | 12 |



Brass Universal Quick Coupler

- Rugged Solid Brass Construction
- Precision Machined for Leak-Proof Operation
- Allows One-Touch Connecting and Disconnecting of Tools and Accessories
- Universal Design Fits any Style 1/4" NPT Quick Connect Male Plug
- Air Inlet: 1/4" NPT

| Item | Description | Packaging | Cs | In |
|------|-------------------------------|--------------------|-----|----|
| 4727 | Brass Universal Quick Coupler | SLIDE BLISTER CARD | 144 | 12 |



2-pc. 25' x 1/2" Thread Sealing Tape

- Seals Tapered Threaded Metal and Plastic Pipe Connections
- PTFE Tape Reduces Friction and Plugs Gaps Between Threads to Create a Leak-Free Seal
- Suitable for Water and Air Connections

| Item | Description | Packaging | Cs | In |
|------|--------------------------------------|--------------------|-----|----|
| 7400 | 2-pc. 25' x 1/2" Thread Sealing Tape | SLIDE BLISTER CARD | 300 | 10 |



Brass Air Regulators

4570

- Solid Brass Construction
- Thumbscrew Valve Control
- Controls Air Flow to Fine-Tune Performance of Sanders, Spray Guns, and other Tools
- 1/4" NPT Inlet x 1/4" NPT Outlet

4575

- Solid Brass Construction
- Thumbscrew Valve Control
- 160 PSI Air Pressure Gauge
- Controls Air Flow to Fine-Tune Performance of Sanders, Spray Guns, and other Tools
- 1/4" NPT Inlet x 1/4" NPT Outlet

| Item | Description | Packaging | Cs | In |
|------|--------------------------|--------------------|-----|----|
| 4570 | Brass Air Regulator | SLIDE BLISTER CARD | 200 | 10 |
| 4575 | Air Regulator with Gauge | SLIDE BLISTER CARD | 100 | 10 |



In-Line Air Regulator with Gauge

- High-Contrast, Easy-Read Dial Gauge
- Oversized Locking Air Pressure Adjustment Knob
- Controls Air Pressure Providing Smooth and Consistent Tool Performance
- Protects Hoses, Tools, and Accessories from Damage

Specifications:

- Maximum Air Pressure: 150 PSI
- Air Inlet: 3/8" NPT
- Air Outlet: 3/8" NPT
- Not Recommended for Air Compressors Over 5 HP

| Item | Description | Packaging | Cs | In |
|------|----------------------------------|-----------------------|----|----|
| 4582 | In-Line Air Regulator with Gauge | SEALED BLISTER - FULL | 12 | 6 |



In-Line Air Filter

- Traps and Removes Harmful Water Vapor and Debris Particles from Compressed Air Supply
- Metal Outer Shield Protects Internal Filter Unit
- Easy-Clean Filter with Brass Drain Valve
- Delivers Clean Air Supply to Maximize Tool Performance
- Protects Hoses, Tools, and Accessories from Excessive Wear and Damage

Specifications:

- Maximum Air Pressure: 150 PSI
- Air Inlet: 3/8" NPT
- Air Outlet: 3/8" NPT
- Not Recommended for Air Compressors Over 5 HP

| Item | Description | Packaging | Cs | In |
|------|--------------------|-----------------------|----|----|
| 4583 | In-Line Air Filter | SEALED BLISTER - FULL | 12 | 6 |



Air Filter/Regulator/Lubricator Unit

- All-in-One Air Management System
- Air Regulator Controls Air Pressure and Provides Smooth, Consistent Tool Performance
- Regulator Gauge Measures Air Pressure up to 160 PSI
- Filter Device Removes Harmful Solid and Liquid Particles from Air Flow
- Brass Drain Valves for Filter and Lubricator
- Micro-Fog Lubricator Supplies Lubricating Oil Mist to Working Air Tools in Proper Proportion to Air Consumption
- The Combined Unit Effectively Extends the Life of Air Tools and Reduces Maintenance and Repair Costs
- Air Inlet: 3/8" NPT
- Air Outlet: 3/8" NPT

| Item | Description | Packaging | Cs | In |
|------|--------------------------------------|-----------------------|----|----|
| 4592 | Air Filter/Regulator/Lubricator Unit | SEALED BLISTER - FULL | 5 | 1 |



Small Air Control Unit

- Complete Air Management System Includes Filter, Regulator, and Shut-Off Valve
- Filter Traps and Removes Harmful Water Vapor and Debris Particles from Compressed Air Supply
- Easy-Clean Filter Canister with Brass Drain Valve
- Regulator Features High-Contrast Dial Face and Oversized Adjustment Knob
- Delivers Clean Air Supply to Maximize Tool Performance
- Protects Hoses, Tools, and Accessories from Excessive Wear and Damage

- Maximum Air Pressure: 150 PSI
- Filter (Maximum Flow Rate): 50 CFM
- Regulator (Maximum Flow Rate): 40 CFM
- Air Inlet - to Filter (NPT): 1/2"
- Air Outlet - from Regulator (NPT): 1/4"
- Not Recommended for Air Compressors Over 5 HP

| Item | Description | Packaging | Cs | In |
|------|------------------------|-----------------------|----|----|
| 4585 | Small Air Control Unit | SEALED BLISTER - FULL | 6 | 1 |



Large Air Control Unit

- Complete Air Management System Includes Filter, Regulator, and Shut-Off Valve
- Filter Traps and Removes Harmful Water Vapor and Debris Particles from Compressed Air Supply
- Easy-Clean Filter Canister with Brass Drain Valve
- Regulator Features High-Contrast Dial Face and Oversized Adjustment Knob
- Delivers Clean Air Supply to Maximize Tool Performance
- Protects Hoses, Tools, and Accessories from Excessive Wear and Damage

- Maximum Air Pressure: 150 PSI
- Filter (Maximum Flow Rate): 80 CFM
- Regulator (Maximum Flow Rate): 40 CFM
- Air Inlet - to Filter (NPT): 1/2"
- Air Outlet - from Regulator (NPT): 1/4"
- Not Recommended for Air Compressors Over 5 HP

| Item | Description | Packaging | Cs | In |
|------|------------------------|-----------------------|----|----|
| 4590 | Large Air Control Unit | SEALED BLISTER - FULL | 6 | 1 |

Oil/Water Separator

- Eliminates Water Buildup in Air Line
- Traps Water Vapor to Maximize Air Tool Performance and Extend Tool Life

Specifications:

- Max. Air Pressure: 150 PSI
- Air Inlet: 1/4" NPT
- Air Outlet: 1/4" NPT

| Item | Description | Packaging | Cs | In |
|------|---------------------|--------------|----|----|
| 4755 | Oil/Water Separator | BLISTER CARD | 72 | 12 |





Retractable Air Hose Reels

- Heavy Duty Industrial Grade Rubber Air Hose
- Heavy Gauge All Steel Reel Assembly
- 8-Position Ratchet Gearing Locks Reel at Desired Hose Length
- Features Auto Rewind, Spring-Powered Automatic Recoil
- Mount Reel on Ceiling, Wall, or Floor - Wherever it is Most Convenient

| Item # | Hose Size | Air Inlet to Reel | Hose End Fittings | Max. Capacity | Max. Air Flow |
|--------|------------|-------------------|-------------------|---------------|---------------|
| 4677 | 3/8" x 25' | 1/4" NPT (F) | 1/4" NPT (M) | 300PSI | 25 CFM |
| 4678 | 3/8" x 50' | 1/4" NPT (F) | 1/4" NPT (M) | 300PSI | 25 CFM |
| 4679 | 1/2" x 50' | 1/2" NPT (F) | 1/2" NPT (M) | 300PSI | 35 CFM |

| Item | Description | Packaging | Cs | In |
|------|--------------------------------------|-----------|----|----|
| 4677 | 25' x 3/8" Retractable Air Hose Reel | COLOR BOX | 1 | 1 |
| 4678 | 50' x 3/8" Retractable Air Hose Reel | COLOR BOX | 1 | 1 |
| 4679 | 50' x 1/2" Retractable Air Hose Reel | COLOR BOX | 1 | 1 |

Manual Open Frame Hose Reel (100' Capacity)

- 100' Air Hose Capacity (hose not included)
- 1/4" NPT Air Inlet, 300 PSI Max. Working Pressure
- Precision Machined Brass Air Inlet Fitting for Leak-Free Operation
- Open Frame All Steel Design
- One-Piece "U" Mounting Bracket
- Spring Tension Axle Brake Stops and Holds Reel at Desired Position
- Comfortable Swivel Crank Handle
- Rugged Corrosion-Resistant Powder Coat Finish
- Mount on Floor, Wall, Workbench, or Vehicle

| Item | Description | Packaging | Cs | In |
|------|---|-----------|----|----|
| 4682 | Manual Open Frame Hose Reel (100' Capacity) | COLOR BOX | 1 | 1 |



50' and 100' Manual Hose Reels

- 50' Air Hose Capacity (hose not included)
- 1/4" NPT Air Inlet, 300 PSI Max. Working Pressure
- Precision Machined Brass Air Inlet Fitting for Leak-Free Operation
- Heavy Gauge All Steel Construction
- One-Piece "U" Mounting Bracket
- Spring Tension Axle Brake Stops and Holds Reel at Desired Position
- Comfortable Swivel Crank Handle
- Rugged Corrosion-Resistant Powder Coat Finish
- Mount on Floor, Wall, Workbench, or Vehicle

- 4687
- 100' Air Hose Capacity (hose not included)

| Item | Description | Packaging | Cs | In |
|------|----------------------------------|-----------|----|----|
| 4685 | Manual Hose Reel (50' Capacity) | COLOR BOX | 1 | 1 |
| 4687 | Manual Hose Reel (100' Capacity) | COLOR BOX | 1 | 1 |



Air Hoses

4625

- Self-Storing Design Springs Back into Coiled Shape After Each Use
- Rugged Oil- and Abrasion-Resistant Nylon Construction
- Leak-Resistant, 360° Swivel Brass End Connectors

- Spring Bend Restrictors Prevent Kinks Near Hose End

- Hose Size: 1/4" I.D. x 25'
- Connector Size: 1/4" NPT
- Working Pressure: 200 PSI

4647 / 4648

- Abrasion, Kink, and Weather-Resistant PVC Construction
- Solid Brass End Fittings: 1/4" NPT
- 200 PSI Working Pressure
- 600 PSI Burst Pressure

| Item | Description | Packaging | Cs | In |
|------|----------------------------|-------------------------|----|----|
| 4625 | 25' x 1/4" Recoil Air Hose | SHRINK WRAP/LABEL | 40 | 10 |
| 4647 | 3/8" x 25' PVC Air Hose | SHRINK WRAP/COLOR LABEL | 10 | 1 |
| 4648 | 3/8" X 50' PVC Air Hose | SHRINK WRAP/COLOR LABEL | 5 | 1 |

- Drop Forged Heat Treated Chrome Vanadium Steel
- Corrosion-Resistant Black Oxide or Phosphate Finish
- Hole on Socket Locks on to Drive Tang
- Meets or Exceeds ANSI Specifications

4934 / 4935 / 4936 / 4938 / 4943

- Drop Forged, Heat Treated Chrome Molybdenum Steel

OPTI-DRIVE™ DESIGN:

- Eliminates Corner Contact to Prevent Fastener from Rounding Off

| Item | Description | Packaging | Cs | In |
|-------|--|------------------------|-----|----|
| 47750 | 1/2" Drive x 7/16" Shallow Impact Socket | PLASTIC HANG TAB/LABEL | 144 | 6 |
| 47751 | 1/2" Drive x 1/2" Shallow Impact Socket | PLASTIC HANG TAB/LABEL | 144 | 6 |
| 47752 | 1/2" Drive x 9/16" Shallow Impact Socket | PLASTIC HANG TAB/LABEL | 144 | 6 |
| 47753 | 1/2" Drive x 5/8" Shallow Impact Socket | PLASTIC HANG TAB/LABEL | 144 | 6 |
| 47754 | 1/2" Drive x 11/16" Shallow Impact Socket | PLASTIC HANG TAB/LABEL | 144 | 6 |
| 47755 | 1/2" Drive x 3/4" Shallow Impact Socket | PLASTIC HANG TAB/LABEL | 144 | 6 |
| 47756 | 1/2" Drive x 13/16" Shallow Impact Socket | PLASTIC HANG TAB/LABEL | 144 | 6 |
| 47757 | 1/2" Drive x 7/8" Shallow Impact Socket | PLASTIC HANG TAB/LABEL | 144 | 6 |
| 47758 | 1/2" Drive x 15/16" Shallow Impact Socket | PLASTIC HANG TAB/LABEL | 144 | 6 |
| 47759 | 1/2" Drive x 1" Shallow Impact Socket | PLASTIC HANG TAB/LABEL | 144 | 6 |
| 47760 | 1/2" Drive x 1-1/16" Shallow Impact Socket | PLASTIC HANG TAB/LABEL | 144 | 6 |
| 47761 | 1/2" Drive x 1-1/8" Shallow Impact Socket | PLASTIC HANG TAB/LABEL | 72 | 6 |
| 47762 | 1/2" Drive x 1-1/4" Shallow Impact Socket | PLASTIC HANG TAB/LABEL | 72 | 6 |
| 47765 | 1/2" Drive x 10mm Shallow Impact Socket | PLASTIC HANG TAB/LABEL | 144 | 6 |
| 47766 | 1/2" Drive x 11mm Shallow Impact Socket | PLASTIC HANG TAB/LABEL | 144 | 6 |
| 47767 | 1/2" Drive x 12mm Shallow Impact Socket | PLASTIC HANG TAB/LABEL | 144 | 6 |
| 47768 | 1/2" Drive x 13mm Shallow Impact Socket | PLASTIC HANG TAB/LABEL | 144 | 6 |
| 47769 | 1/2" Drive x 14mm Shallow Impact Socket | PLASTIC HANG TAB/LABEL | 144 | 12 |
| 47770 | 1/2" Drive x 15mm Shallow Impact Socket | PLASTIC HANG TAB/LABEL | 144 | 6 |
| 47771 | 1/2" Drive x 16mm Shallow Impact Socket | PLASTIC HANG TAB/LABEL | 144 | 6 |
| 47772 | 1/2" Drive x 17mm Shallow Impact Socket | PLASTIC HANG TAB/LABEL | 144 | 6 |
| 47773 | 1/2" Drive x 18mm Shallow Impact Socket | PLASTIC HANG TAB/LABEL | 144 | 6 |
| 47774 | 1/2" Drive x 19mm Shallow Impact Socket | PLASTIC HANG TAB/LABEL | 144 | 6 |
| 47776 | 1/2" Drive x 21mm Shallow Impact Socket | PLASTIC HANG TAB/LABEL | 144 | 6 |
| 47777 | 1/2" Drive x 22mm Shallow Impact Socket | PLASTIC HANG TAB/LABEL | 144 | 6 |
| 47778 | 1/2" Drive x 24mm Shallow Impact Socket | PLASTIC HANG TAB/LABEL | 144 | 6 |
| 47779 | 1/2" Drive x 27mm Shallow Impact Socket | PLASTIC HANG TAB/LABEL | 144 | 6 |
| 47780 | 1/2" Drive x 30mm Shallow Impact Socket | PLASTIC HANG TAB/LABEL | 72 | 6 |
| 47781 | 1/2" Drive x 32mm Shallow Impact Socket | PLASTIC HANG TAB/LABEL | 72 | 6 |
| 47785 | 1/2" Drive x 7/16" Deep Impact Socket | PLASTIC HANG TAB/LABEL | 144 | 6 |
| 47786 | 1/2" Drive x 1/2" Deep Impact Socket | PLASTIC HANG TAB/LABEL | 144 | 6 |
| 47787 | 1/2" Drive x 9/16" Deep Impact Socket | PLASTIC HANG TAB/LABEL | 144 | 6 |
| 47788 | 1/2" Drive x 5/8" Deep Impact Socket | PLASTIC HANG TAB/LABEL | 144 | 6 |
| 47789 | 1/2" Drive x 11/16" Deep Impact Socket | PLASTIC HANG TAB/LABEL | 144 | 6 |
| 47790 | 1/2" Drive x 3/4" Deep Impact Socket | PLASTIC HANG TAB/LABEL | 144 | 6 |
| 47791 | 1/2" Drive x 13/16" Deep Impact Socket | PLASTIC HANG TAB/LABEL | 144 | 6 |
| 4929 | 3/8" Drive x 7/8" Oxygen Sensor Socket | PLASTIC HANG TAB/LABEL | 100 | 10 |
| 47792 | 1/2" Drive x 7/8" Deep Impact Socket | PLASTIC HANG TAB/LABEL | 72 | 6 |
| 47793 | 1/2" Drive x 15/16" Deep Impact Socket | PLASTIC HANG TAB/LABEL | 72 | 6 |
| 47794 | 1/2" Drive x 1" Deep Impact Socket | PLASTIC HANG TAB/LABEL | 72 | 6 |
| 47795 | 1/2" Drive x 1-1/16" Deep Impact Socket | PLASTIC HANG TAB/LABEL | 72 | 6 |
| 47796 | 1/2" Drive x 1-1/8" Deep Impact Socket | PLASTIC HANG TAB/LABEL | 72 | 6 |
| 47797 | 1/2" Drive x 1-1/4" Deep Impact Socket | PLASTIC HANG TAB/LABEL | 48 | 6 |
| 47801 | 1/2" Drive x 10mm Deep Impact Socket | PLASTIC HANG TAB/LABEL | 144 | 6 |
| 47802 | 1/2" Drive x 11mm Deep Impact Socket | PLASTIC HANG TAB/LABEL | 144 | 6 |
| 47803 | 1/2" Drive x 12mm Deep Impact Socket | PLASTIC HANG TAB/LABEL | 144 | 6 |
| 47804 | 1/2" Drive x 13mm Deep Impact Socket | PLASTIC HANG TAB/LABEL | 144 | 6 |
| 47805 | 1/2" Drive x 14mm Deep Impact Socket | PLASTIC HANG TAB/LABEL | 144 | 6 |
| 47806 | 1/2" Drive x 15mm Deep Impact Socket | PLASTIC HANG TAB/LABEL | 144 | 6 |
| 47807 | 1/2" Drive x 16mm Deep Impact Socket | PLASTIC HANG TAB/LABEL | 144 | 6 |
| 47808 | 1/2" Drive x 17mm Deep Impact Socket | PLASTIC HANG TAB/LABEL | 144 | 6 |
| 47809 | 1/2" Drive x 18mm Deep Impact Socket | PLASTIC HANG TAB/LABEL | 144 | 6 |
| 47810 | 1/2" Drive x 19mm Deep Impact Socket | PLASTIC HANG TAB/LABEL | 144 | 6 |
| 47812 | 1/2" Drive x 21mm Deep Impact Socket | PLASTIC HANG TAB/LABEL | 144 | 6 |
| 47813 | 1/2" Drive x 22mm Deep Impact Socket | PLASTIC HANG TAB/LABEL | 72 | 6 |
| 47814 | 1/2" Drive x 24mm Deep Impact Socket | PLASTIC HANG TAB/LABEL | 72 | 6 |
| 47815 | 1/2" Drive x 27mm Deep Impact Socket | PLASTIC HANG TAB/LABEL | 72 | 6 |
| 4942 | 1/2" Drive x 29mm Heavy Duty FWD Impact Socket | PLASTIC HANG TAB/LABEL | 40 | 5 |
| 4930 | 1/2" Drive x 30mm Heavy Duty FWD Impact Socket | PLASTIC HANG TAB/LABEL | 48 | 8 |
| 4932 | 1/2" Drive x 32mm Heavy Duty FWD Impact Socket | PLASTIC HANG TAB/LABEL | 30 | 6 |
| 4943 | 1/2" Drive x 33mm Deep Impact Socket | PLASTIC HANG TAB/LABEL | 40 | 5 |
| 4933 | 3/4" Drive x 33mm Truck Lug Impact Socket | PLASTIC HANG TAB/LABEL | 30 | 6 |
| 4934 | 1/2" Drive x 34mm Heavy Duty FWD Impact Socket | PLASTIC HANG TAB/LABEL | 30 | 6 |
| 4935 | 1/2" Drive x 35mm Heavy Duty FWD Impact Socket | PLASTIC HANG TAB/LABEL | 30 | 6 |
| 4936 | 1/2" Drive x 36mm Heavy Duty FWD Impact Socket | PLASTIC HANG TAB/LABEL | 30 | 6 |
| 4938 | 1/2" Drive x 38mm Heavy Duty FWD Impact Socket | PLASTIC HANG TAB/LABEL | 24 | 6 |
| 47820 | 1/2" Drive (F) x 3/8" (M) Impact Reducer | PLASTIC HANG TAB/LABEL | 72 | 6 |
| 47821 | 1/2" Drive (M) x 3/8" (F) Impact Adapter | PLASTIC HANG TAB/LABEL | 72 | 6 |
| 47822 | 1/2" Drive (F) x 3/4" (M) Impact Adapter | PLASTIC HANG TAB/LABEL | 72 | 6 |
| 47823 | 3/4" Drive (F) x 1/2" (M) Impact Reducer | PLASTIC HANG TAB/LABEL | 72 | 6 |
| 47824 | 1/2" Drive Impact Universal Joint | PLASTIC HANG TAB/LABEL | 72 | 6 |
| 47825 | 1/2" Drive x 3" Impact Extension Bar | PLASTIC HANG TAB/LABEL | 72 | 6 |
| 47826 | 1/2" Drive x 5" Impact Extension | PLASTIC HANG TAB/LABEL | 72 | 6 |
| 47827 | 1/2" Drive x 10" Impact Extension | PLASTIC HANG TAB/LABEL | 72 | 6 |

Large, easy-to-read, laser-etched size on each socket



Shallow Socket

Deep Socket

Adapters and Reducers

Extensions

Universal Joints

PACKAGING

- Space-Saving Hang Tabs Hold Sockets Securely and Allow Customers Hands-On Interaction with Product
- Easy-to-Read Size, Specifications, and ANSI Rating on Front Side
- Lifetime Warranty and Barcode on Reverse Side

BLACK tabs for SAE sizes

RED tabs for METRIC sizes



COLOR-CODED TABS



9-pc. 3/8" Drive Shallow Impact Socket Sets

- Drop Forged, Heat Treated Chrome Vanadium Steel
- Corrosion-Resistant Black Phosphate Finish
- 6-Point, Beveled-Nose Sockets
- Hole on Socket Locks on to Drive Tang
- Meets or Exceeds ANSI Specifications
- Opti-Drive™ Socket Design Contacts Only Flat Surfaces of Fastener Head to Eliminate Rounding Off Corners

4790

- 8-pc. 3/8" Dr. Sockets (SAE): 5/16", 3/8", 7/16", 1/2", 9/16", 5/8", 11/16", 3/4"
- 1-pc. Storage Case

4795

- 8-pc. 3/8" Dr. Sockets (Metric) 10, 11, 12, 13, 15, 17, 18, 19mm
- 1-pc. Storage Case

| Item | Description | Packaging | Cs | In |
|------|---|-----------|----|----|
| 4790 | 9-pc. 3/8" Drive Shallow Impact Socket Set (SAE) | COLOR BOX | 30 | 1 |
| 4795 | 9-pc. 3/8" Drive Shallow Impact Socket Set (Metric) | COLOR BOX | 30 | 1 |



11-pc. 1/2" Drive Shallow Impact Socket Sets

- Drop Forged, Heat Treated Chrome Vanadium Steel
- Corrosion-Resistant Black Phosphate Finish
- 6-Point, Beveled-Nose Sockets
- Hole on Socket Locks on to Drive Tang
- Meets or Exceeds ANSI Specifications
- Opti-Drive™ Socket Design Contacts Only Flat Surfaces of Fastener Head to Eliminate Rounding Off Corners

4810

- 10-pc. 1/2" Dr. Sockets (SAE): 7/16, 1/2, 9/16, 5/8, 11/16, 3/4, 13/16, 7/8, 15/16, 1"
- 1-pc. Storage Case

4815

- 10-pc. 1/2" Dr. Sockets (Metric): 11, 12, 13, 15, 17, 18, 19, 21, 22, 24mm
- 1-pc. Storage Case

| Item | Description | Packaging | Cs | In |
|------|--|-----------|----|----|
| 4810 | 11-pc. 1/2" Drive Shallow Impact Socket Set (SAE) | COLOR BOX | 20 | 1 |
| 4815 | 11-pc. 1/2" Drive Shallow Impact Socket Set (Metric) | COLOR BOX | 20 | 1 |



15-pc. 1/2" Drive Shallow Impact Socket Sets

- Drop Forged, Heat Treated Chrome Vanadium Steel
- Corrosion-Resistant Black Phosphate Finish
- 6-Point, Beveled-Nose Sockets
- Hole on Socket Locks on to Drive Tang
- Meets or Exceeds ANSI Specifications
- Opti-Drive™ Socket Design Contacts Only Flat Surfaces of Fastener Head to Eliminate Rounding Off Corners

4816

- 14-pc. 1/2" Dr. Sockets (SAE): 3/8, 7/16, 1/2, 9/16, 5/8, 11/16, 3/4, 13/16, 7/8, 15/16, 1, 1-1/16, 1-1/8, 1-1/4"
- 1-pc. Storage Case

4817

- 14-pc. 1/2" Dr. Sockets (Metric): 11, 12, 13, 14, 15, 17, 18, 19, 21, 22, 24, 27, 30, 32mm
- 1-pc. Storage Case

| Item | Description | Packaging | Cs | In |
|------|--|-----------|----|----|
| 4816 | 15-pc. 1/2" Drive Shallow Impact Socket Set (SAE) | COLOR BOX | 12 | 1 |
| 4817 | 15-pc. 1/2" Drive Shallow Impact Socket Set (Metric) | COLOR BOX | 12 | 1 |



4818



4886



5-pc. 1/2" Drive Jumbo Impact Socket Sets (SAE)

- Drop Forged, Heat Treated Chrome Molybdenum Steel
- Corrosion-Resistant Black Phosphate Finish
- 6-Point, Beveled-Nose Sockets
- Hole on Socket Locks on to Drive Tang
- Meets or Exceeds ANSI Specifications
- Opti-Drive™ Socket Design Contacts Only Flat Surfaces of Fastener Head to Eliminate Rounding Off Corners

4818 / 4886

- 5-pc. 1/2" Drive Impact Sockets (SAE): 1-3/16", 1-5/16", 1-3/8", 1-7/16", 1-1/2"
- 1-pc. Storage Case

| Item | Description | Packaging | Cs | In |
|------|--|--------------------------|----|----|
| 4818 | 5-pc. 1/2" Drive Shallow Jumbo Impact Socket Set (SAE) | WHITE SLEEVE/COLOR LABEL | 6 | 1 |
| 4886 | 5-pc. 1/2" Drive Deep Jumbo Impact Socket Set (SAE) | WHITE SLEEVE/COLOR LABEL | 6 | 1 |

9-pc. 3/4" Drive Shallow Impact Socket Set (SAE)

- Drop Forged, Heat Treated Chrome Vanadium Steel
- Corrosion-Resistant Black Phosphate Finish
- 6-Point, Beveled-Nose Sockets
- Hole on Socket Locks on to Drive Tang
- Meets or Exceeds ANSI Specifications
- Opti-Drive™ Socket Design Contacts Only Flat Surfaces of Fastener Head to Eliminate Rounding Off Corners
- 8-pc. 3/4" Dr. Sockets (SAE): 1", 1-1/16, 1-1/8, 1-1/4, 1-5/16, 1-3/8, 1-7/16, 1-1/2"
- 1-pc. Storage Case

| Item | Description | Packaging | Cs | In |
|------|--|-----------|----|----|
| 4820 | 9-pc. 3/4" Drive Shallow Impact Socket Set (SAE) | COLOR BOX | 6 | 1 |

9-pc. 1/4" Drive Deep Impact Socket Sets

- Drop Forged, Heat Treated Carbon Steel
- Corrosion-Resistant Black Oxide Finish
- 6-Point, Beveled-Nose Sockets
- Hole on Socket Locks on to Drive Tang
- Meets or Exceeds ANSI Specifications
- Opti-Drive™ Socket Design Contacts Only Flat Surfaces of Fastener Head to Eliminate Rounding Off Corners

4825

- 8-pc. 1/4" Dr. Sockets (SAE): 3/16, 7/32, 1/4, 9/32, 5/16, 11/32, 3/8, 7/16"
- 1-pc. Storage Case

4830

- 8-pc. 1/4" Dr. Sockets (Metric): 5.5, 6, 7, 8, 9, 10, 11, 12mm
- 1-pc. Storage Case

| Item | Description | Packaging | Cs | In |
|------|--|-----------|----|----|
| 4825 | 9-pc. 1/4" Drive Deep Impact Socket Set (SAE) | COLOR BOX | 36 | 1 |
| 4830 | 9-pc. 1/4" Drive Deep Impact Socket Set (Metric) | COLOR BOX | 36 | 1 |





9-pc. 3/8" Drive Deep Impact Socket Sets

- Drop Forged, Heat Treated Carbon Steel
 - Corrosion-Resistant Black Oxide Finish
 - 6-Point, Beveled-Nose Sockets
 - Hole on Socket Locks on to Drive Tang
 - Meets or Exceeds ANSI Specifications
- Opti-Drive™ Socket Design Contacts Only Flat Surfaces of Fastener Head to Eliminate Rounding Off Corners

4835

- 8-pc. 3/8" Dr. Sockets (SAE): 3/8, 7/16, 1/2, 9/16, 5/8, 11/16, 3/4, 13/16"
- 1-pc. Storage Case

4840

- 8-pc. 3/8" Dr. Sockets (Metric): 10, 11, 12, 13, 15, 17, 18, 19
- 1-pc. Storage Case

| Item | Description | Packaging | Cs | In |
|------|--|-----------|----|----|
| 4835 | 9-pc. 3/8" Drive Deep Impact Socket Set (SAE) | COLOR BOX | 20 | 1 |
| 4840 | 9-pc. 3/8" Drive Deep Impact Socket Set (Metric) | COLOR BOX | 20 | 1 |



9-pc. 3/8" Drive Deep Impact Socket Sets

- Drop Forged, Heat Treated Chrome Vanadium Steel
 - Corrosion-Resistant Black Phosphate Finish
 - 6-Point, Beveled-Nose Sockets
 - Hole on Socket Locks on to Drive Tang
 - Meets or Exceeds ANSI Specifications
- Opti-Drive™ Socket Design Contacts Only Flat Surfaces of Fastener Head to Eliminate Rounding Off Corners

4845

- 8-pc. 3/8" Dr. Sockets (SAE): 3/8, 7/16, 1/2, 9/16, 5/8, 11/16, 3/4, 13/16"
- 1-pc. Storage Case

4850

- 8-pc. 3/8" Dr. Sockets (Metric): 10, 11, 12, 13, 15, 17, 18, 19mm
- 1-pc. Storage Case

| Item | Description | Packaging | Cs | In |
|------|--|-----------|----|----|
| 4845 | 9-pc. 3/8" Drive Deep Impact Socket Set (SAE) | COLOR BOX | 20 | 1 |
| 4850 | 9-pc. 3/8" Drive Deep Impact Socket Set (Metric) | COLOR BOX | 20 | 1 |



12-pc. 1/2" Drive Deep Impact Socket Sets

- Drop Forged, Heat Treated Carbon Steel
 - Corrosion-Resistant Black Oxide Finish
 - 6-Point, Beveled-Nose Sockets
 - Hole on Socket Locks on to Drive Tang
 - Meets or Exceeds ANSI Specifications
- Opti-Drive™ Socket Design Contacts Only Flat Surfaces of Fastener Head to Eliminate Rounding Off Corners

4855

- 11-pc. 1/2" Dr. Sockets (SAE): 3/8, 7/16, 1/2, 9/16, 5/8, 11/16, 3/4, 13/16, 7/8, 15/16, 1"
- 1-pc. Storage Case

4860

- 11-pc. 1/2" Dr. Sockets (Metric): 10, 11, 12, 13, 15, 17, 18, 19, 21, 22, 24mm
- 1-pc. Storage Case

| Item | Description | Packaging | Cs | In |
|------|---|-----------|----|----|
| 4855 | 12-pc. 1/2" Drive Deep Impact Socket Set (SAE) | COLOR BOX | 10 | 1 |
| 4860 | 12-pc. 1/2" Drive Deep Impact Socket Set (Metric) | COLOR BOX | 10 | 1 |

12-pc. 1/2" Drive Deep Impact Socket Sets

- Drop Forged, Heat Treated Chrome Vanadium Steel
- Corrosion-Resistant Black Phosphate Finish
- 6-Point, Beveled-Nose Sockets
- Hole on Socket Locks on to Drive Tang
- Meets or Exceeds ANSI Specifications
- Opti-Drive™ Socket Design Contacts Only Flat Surfaces of Fastener Head to Eliminate Rounding Off Corners

4865

- 11-pc. 1/2" Dr. Sockets (SAE): 3/8, 7/16, 1/2, 9/16, 5/8, 11/16, 3/4, 13/16, 7/8, 15/16, 1"
- 1-pc. Storage Case

4870

- 11-pc. 1/2" Dr. Sockets (Metric): 10, 11, 12, 13, 15, 17, 18, 19, 21, 22, 24mm
- 1-pc. Storage Case

| Item | Description | Packaging | Cs | In |
|------|---|-----------|----|----|
| 4865 | 12-pc. 1/2" Drive Deep Impact Socket Set (SAE) | COLOR BOX | 10 | 1 |
| 4870 | 12-pc. 1/2" Drive Deep Impact Socket Set (Metric) | COLOR BOX | 10 | 1 |



15-pc. 1/2" Drive Deep Impact Socket Sets

- Drop Forged, Heat Treated Carbon Steel
- Corrosion-Resistant Black Oxide Finish
- 6-Point, Beveled-Nose Sockets
- Hole on Socket Locks on to Drive Tang
- Meets or Exceeds ANSI Specifications
- Opti-Drive™ Socket Design Contacts Only Flat Surfaces of Fastener Head to Eliminate Rounding Off Corners

4875

- 14-pc. 1/2" Dr. Sockets (SAE): 3/8, 7/16, 1/2, 9/16, 5/8, 11/16, 3/4, 13/16, 7/8, 15/16, 1, 1-1/16, 1-1/8, 1-1/4"
- 1-pc. Storage Case

4878

- 14-pc. 1/2" Dr. Sockets (Metric): 11, 12, 13, 14, 15, 17, 18, 19, 21, 22, 24, 27, 30, 32mm
- 1-pc. Storage Case

| Item | Description | Packaging | Cs | In |
|------|---|-----------|----|----|
| 4875 | 15-pc. 1/2" Drive Deep Impact Socket Set (SAE) | COLOR BOX | 6 | 1 |
| 4878 | 15-pc. 1/2" Drive Deep Impact Socket Set (Metric) | COLOR BOX | 6 | 1 |



15-pc. 1/2" Drive Deep Impact Socket Sets

- Drop Forged, Heat Treated Chrome Vanadium Steel
- Corrosion-Resistant Black Phosphate Finish
- 6-Point, Beveled-Nose Sockets
- Hole on Socket Locks on to Drive Tang
- Meets or Exceeds ANSI Specifications
- Opti-Drive™ Socket Design Contacts Only Flat Surfaces of Fastener Head to Eliminate Rounding Off Corners

4880

- 14-pc. 1/2" Dr. Sockets (SAE): 3/8, 7/16, 1/2, 9/16, 5/8, 11/16, 3/4, 13/16, 7/8, 15/16, 1, 1-1/16, 1-1/8, 1-1/4"
- 1-pc. Storage Case

4885

- 14-pc. 1/2" Dr. Sockets (Metric): 11, 12, 13, 14, 15, 17, 18, 19, 21, 22, 24, 27, 30, 32mm
- 1-pc. Storage Case

| Item | Description | Packaging | Cs | In |
|------|---|-----------|----|----|
| 4880 | 15-pc. 1/2" Drive Deep Impact Socket Set (SAE) | COLOR BOX | 6 | 1 |
| 4885 | 15-pc. 1/2" Drive Deep Impact Socket Set (Metric) | COLOR BOX | 6 | 1 |





38-pc. 3/8" and 1/2" Drive Impact Socket Set (SAE/Metric)

- Drop Forged, Heat Treated Chrome Vanadium Steel
- Corrosion-Resistant Black Electroplate Finish
- 6-Point, Beveled-Nose Sockets
- Hole on Socket Locks on to Drive Tang
- Meets or Exceeds ANSI Specifications
- Opti-Drive™ Socket Design Contacts Only Flat Surfaces of Fastener Head to Eliminate Rounding Off Corners
- 11-pc. Dual-Size Sockets Increase Range of Set by 32% Over Conventional Socket Sets
- 4 Sets in One
- 6-pc. 3/8" Dr. Shallow Impact Socket (SAE): 3/8", 7/16" (11mm), 1/2", 9/16", 11/16", 3/4" (19mm)
- 7-pc. 3/8" Dr. Shallow Impact Socket (MM): 8 (5/16"), 9, 12, 13, 14, 16 (5/8"), 17mm
- 11-pc. 1/2" Dr. Shallow Impact Socket (MM): 10, 11 (7/16"), 12, 13, 14, 15, 16 (5/8"), 17, 18, 21, 24mm (15/16")
- 10-pc. 1/2" Dr. Deep Impact Socket (SAE): 1/2", 9/16", 11/16", 3/4" (19mm), 13/16", 7/8" (22mm), 1", 1-1/16" (27mm), 1-1/8", 1-1/4" (32mm)
- 1-pc. 1/2" (F) x 3/8" (M) Adapter
- 1-pc. 3/8" Dr. x 3" Extension Bar
- 1-pc. 1/2" Dr. x 3" Extension Bar
- 1-pc. Storage Case

| Item | Description | Packaging | Cs | In |
|------|---|-----------|----|----|
| 4888 | 38-pc. 3/8" and 1/2" Drive Impact Socket Set (SAE/Metric) | COLOR BOX | 4 | 1 |



9-pc. 3/4" Drive Deep Impact Socket Sets

- Drop Forged, Heat Treated Chrome Vanadium Steel
- Corrosion-Resistant Black Phosphate Finish
- 6-Point Beveled-Nose Sockets
- Hole on Socket Locks on to Drive Tang
- Meets or Exceeds ANSI Specifications
- Opti-Drive™ Socket Design Contacts Only Flat Surfaces of Fastener Head to Eliminate Rounding Off Corners

- 4889
- 8-pc. 3/4" Drive Impact Sockets (Metric): 27, 29, 30, 32, 33, 34, 36, 38mm
 - 1-pc. Storage Case

- 4891
- 8-pc. 3/4" Dr. Socket (SAE): 1", 1-1/16", 1-1/8", 1-1/4", 1-5/16", 1-3/8", 1-7/16", 1-1/2"
 - 1-pc. Storage Case

| Item | Description | Packaging | Cs | In |
|------|---|-----------|----|----|
| 4889 | 9-pc. 3/4" Drive Deep Impact Socket Set | COLOR BOX | 5 | 1 |
| 4891 | 9-pc. 3/4" Drive Deep Impact Socket Set (SAE) | COLOR BOX | 5 | 1 |



8-pc. 3/4" Drive Deep Impact Socket Set (SAE)

- Drop Forged, Heat Treated Chrome Molybdenum and Chrome Vanadium Steel
- Corrosion-Resistant Black Phosphate Finish
- 6-Point, Beveled-Nose Sockets
- Hole on Socket Locks on to Drive Tang
- Meets or Exceeds ANSI Specifications
- Opti-Drive™ Socket Design Contacts Only Flat Surfaces of Fastener Head to Eliminate Rounding Off Corners
- 6-pc. 3/4" Dr. Sockets Sizes (SAE): 15/16, 1", 1-1/16, 1-1/8, 1-1/4, 1-1/2"
- 1-pc. 3/4" Dr. x 13/16" Square Lug Socket
- 1-pc. Storage Case

| Item | Description | Packaging | Cs | In |
|------|---|-----------|----|----|
| 4890 | 8-pc. 3/4" Drive Deep Impact Socket Set (SAE) | COLOR BOX | 5 | 1 |

10-pc. 1" Drive Deep Impact Socket Set (SAE)

- Drop Forged, Heat Treated Chrome Molybdenum and Chrome Vanadium Steel
- Corrosion-Resistant Black Phosphate Finish
- 6-Point, Beveled-Nose Sockets
- Hole on Socket Locks on to Drive Tang
- Meets or Exceeds ANSI Specifications
- Opti-Drive™ Socket Design Contacts Only Flat Surfaces of Fastener Head to Eliminate Rounding Off Corners
- 9-pc. 1" Dr. Impact Sockets (SAE): (CrMo) 1", 1-1/8, 1-1/4, 1-3/8, 1-1/2, 1-5/8, (CrV) 1-3/4, 1-7/8, 2"
- 1-pc. Metal Storage/Carry Case

| Item | Description | Packaging | Cs | In |
|------|--|-----------------------|----|----|
| 4892 | 10-pc. 1" Drive Deep Impact Socket Set (SAE) | WHITE BOX/COLOR LABEL | 2 | 1 |



8-pc. 3/4" Drive Shallow Impact Socket Set

- Drop Forged, Heat Treated Chrome Molybdenum Steel
- Corrosion-Resistant Black Phosphate Finish
- 6-Point Beveled-Nose Sockets
- Hole on Socket Locks on to Drive Tang
- Meets or Exceeds ANSI Specifications
- Opti-Drive™ Socket Design Contacts Only Flat Surfaces of Fastener Head to Eliminate Rounding Off Corners
- 8-pc. 3/4" Drive Impact Sockets (SAE): 2-1/16, 2-1/8, 2-3/16, 2-1/4, 2-5/16, 2-3/8, 2-7/16, 2-1/2"
- 1-pc. Heavy Duty Carrying Case

| Item | Description | Packaging | Cs | In |
|------|--|--------------|----|----|
| 4893 | 8-pc. 3/4" Drive Shallow Impact Socket Set | COLOR SLEEVE | 2 | 1 |



21-pc. 3/4" Drive Impact Socket Set

- Professional-Grade, Forged and Hardened Chrome Vanadium Steel Construction
- Corrosion-Resistant Black Phosphate Finish
- Beveled-End, 6-Point Impact Sockets
- 24-Tooth, Quick-Release, Lock-On Ratchet with Non-Slip, Knurled Handle Grip
- Meets or Exceeds ANSI Specifications
- Opti-Drive™ Socket Design Contacts Only Flat Surfaces of Fastener Head to Eliminate Rounding Off Corners
- 1-pc. 3/4" Drive 19" Ratchet Handle
- 1-pc. 3/4" Drive 18" Sliding T-Head Breaker Bar
- 2-pc. 3/4" Drive Extensions: 4" and 8"
- 16-pc. 3/4" Drive Impact Sockets: 3/4", 7/8", 15/16", 1", 1-1/16", 1-1/8", 1-3/8", 1-1/4", 1-5/16", 1-3/8", 1-7/16", 1-1/2", 1-5/8", 1-3/4", 1-7/8", 2"
- 1-pc. Carry Case

| Item | Description | Packaging | Cs | In |
|------|-------------------------------------|--------------|----|----|
| 4899 | 21-pc. 3/4" Drive Impact Socket Set | COLOR SLEEVE | 1 | 1 |





8-pc. 3/8" Drive Impact Brake Caliper Bit Set

- Drop Forged, Heat Treated Chrome Vanadium Steel
- Corrosion-Resistant Black Oxide Finish
- Precision-Machined Tip for Exact Fit
- Locks on to Drive Tang
- Common Sizes for Disc Brake Calipers
- 4-pc. 3/8" Dr. Star Sizes: SD-40, SD-45, SD-50, SD-60
- 3-pc. 3/8" Dr. Hex Sizes (SAE): 1/4", 5/16", 3/8"
- 1-pc. Organizer Rail

| Item | Description | Packaging | Cs | In |
|------|---|--------------------|----|----|
| 4908 | 8-pc. 3/8" Drive Impact Brake Caliper Bit Set | SLIDE BLISTER CARD | 48 | 6 |



6-pc. 3/8" Drive Impact Star Bit Socket Set

- Drop Forged, Heat Treated Chrome Vanadium Steel
- Corrosion-Resistant Black Oxide Finish
- Precision-Machined Tip for Exact Fit
- Locks on to Drive Tang
- 6-pc. 3/8" Dr. Star Sizes: SD-40, SD-45, SD-47, SD-50, SD-55, SD-60
- 1-pc. Organizer Rail

| Item | Description | Packaging | Cs | In |
|------|---|--------------------|----|----|
| 4911 | 6-pc. 3/8" Drive Impact Star Bit Socket Set | SLIDE BLISTER CARD | 48 | 6 |



15-pc. 1/4" and 3/8" Drive Impact Star Bit Set

- Drop Forged, Heat Treated Chrome Vanadium Steel
- Corrosion-Resistant Black Oxide Finish
- Precision-Machined Tip for Exact Fit
- Locks on to Drive Tang
- 6-pc. 1/4" Dr. Star Sizes: SD-10, SD-15, SD-20, SD-25, SD-27, SD-30
- 6-pc. 3/8" Dr. Star Sizes: SD-40, SD-45, SD-47, SD-50, SD-55, SD-60
- 1-pc. 3/8" Dr. (F) x 1/4" Dr. (M) Adapter
- 2-pc. Organizer Rails

| Item | Description | Packaging | Cs | In |
|------|--|--------------------|----|----|
| 4912 | 15-pc. 1/4" and 3/8" Drive Impact Star Bit Set | SLIDE BLISTER CARD | 36 | 6 |



15-pc. 1/4" and 3/8" Drive Tamper Star Bit Set

- Drop Forged, Heat Treated Chrome Vanadium Steel
- Corrosion-Resistant Black Oxide Finish
- Precision-Machined Tip for Exact Fit
- Locks on to Drive Tang
- 6-pc. 1/4" Dr. Star Sizes: SD-10, SD-15, SD-20, SD-25, SD-27, SD-30
- 6-pc. 3/8" Dr. Star Sizes: SD-40, SD-45, SD-47, SD-50, SD-55, SD-60
- 1-pc. 3/8" Dr. (F) x 1/4" Dr. (M) Adapter
- 2-pc. Organizer Rails

| Item | Description | Packaging | Cs | In |
|------|--|--------------------|----|----|
| 4916 | 15-pc. 1/4" and 3/8" Drive Tamper Star Bit Set | SLIDE BLISTER CARD | 36 | 6 |

3-pc. Impact Extension Bar Sets

4965 / 4970

- Forged and Hardened Carbon Steel
- Corrosion-Resistant Black Oxide Finish
- Locks on to Drive Tang
- Spring-Loaded Ball Bearing Socket Retainer

4966 / 4971

- Forged and Hardened Chrome Vanadium Steel
- Corrosion-Resistant Black Oxide Finish
- Locks on to Drive Tang
- Spring-Loaded Ball Bearing Socket Retainer

4965 / 4966

- 1-pc. 3/8" Dr x 3" Extension Bar
- 1-pc. 3/8" Dr x 6" Extension Bar
- 1-pc. 3/8" Dr x 8" Extension Bar

4970 / 4971

- 1-pc. 1/2" Dr x 3" Extension Bar
- 1-pc. 1/2" Dr x 6" Extension Bar
- 1-pc. 1/2" Dr x 8" Extension Bar

| Item | Description | Packaging | Cs | In |
|------|---|------------------------|----|----|
| 4965 | 3-pc. 3/8" Drive Impact Extension Bar Set | PLASTIC HANG TAB/LABEL | 30 | 6 |
| 4966 | 3-pc. 3/8" Drive Impact Extension Bar Set | PLASTIC HANG TAB/LABEL | 30 | 6 |
| 4970 | 3-pc. 1/2" Drive Impact Extension Bar Set | PLASTIC HANG TAB/LABEL | 30 | 6 |
| 4971 | 3-pc. 1/2" Drive Impact Extension Bar Set | PLASTIC HANG TAB/LABEL | 30 | 6 |



3-pc. Impact Reducer Sets

4955

- Drop Forged, Heat Treated Carbon Steel
- Corrosion-Resistant Black Oxide Finish
- Locks on to Socket and Drive Tang

4955 / 4956

- 1-pc. 3/8"(F) x 1/4"(M)
- 1-pc. 1/2"(F) x 3/8"(M)
- 1-pc. 3/4"(F) x 1/2"(M)

4956

- Drop Forged, Heat Treated Chrome Vanadium Steel
- Corrosion-Resistant Black Oxide Finish
- Locks on to Socket and Drive Tang

| Item | Description | Packaging | Cs | In |
|------|--------------------------|--------------------|----|----|
| 4955 | 3-pc. Impact Reducer Set | SLIDE BLISTER CARD | 96 | 12 |
| 4956 | 3-pc. Impact Reducer Set | SLIDE BLISTER CARD | 72 | 12 |



4-pc. Impact Adapter and Reducer Sets

4957

- Drop Forged, Heat Treated Chrome Vanadium Steel
- Corrosion-Resistant Black Oxide Finish
- Locks on to Socket and Drive Tang

4957 / 4958

- 2-pc. Reducers: 1/2"(F) x 3/8"(M), 3/8"(F) x 1/4"(M)
- 2-pc. Adapters: 3/8"(F) x 1/2"(M), 1/4"(F) x 3/8"(M)

4958

- Drop Forged, Heat Treated Carbon Steel
- Corrosion-Resistant Black Oxide Finish
- Locks on to Socket and Drive Tang

| Item | Description | Packaging | Cs | In |
|------|--------------------------------------|--------------------|----|----|
| 4957 | 4-pc. Impact Adapter and Reducer Set | SLIDE BLISTER CARD | 96 | 12 |
| 4958 | 4-pc. Impact Adapter and Reducer Set | SLIDE BLISTER CARD | 72 | 12 |



3-pc. Impact Adapter Sets

4959

- Drop Forged, Heat Treated Chrome Vanadium Steel
- Corrosion-Resistant Black Oxide Finish
- Locks on to Socket and Drive Tang

4959 / 4960

- 1-pc. 1/4"(F) x 3/8"(M)
- 1-pc. 3/8"(F) x 1/2"(M)
- 1-pc. 1/2"(F) x 3/4"(M)

4960

- Drop Forged, Heat Treated Carbon Steel
- Corrosion-Resistant Black Oxide Finish
- Locks on to Socket and Drive Tang

| Item | Description | Packaging | Cs | In |
|------|--------------------------|--------------------|----|----|
| 4959 | 3-pc. Impact Adapter Set | SLIDE BLISTER CARD | 96 | 12 |
| 4960 | 3-pc. Impact Adapter Set | SLIDE BLISTER CARD | 96 | 12 |



3-pc. Impact Universal Joint Sets

4963

- Drop Forged, Heat Treated Carbon Steel
- Corrosion-Resistant Black Oxide Finish
- Locks on to Socket and Drive Tang

4963 / 4964

- 1-pc. 1/4" Drive
- 1-pc. 3/8" Drive
- 1-pc. 1/2" Drive

4964

- Drop Forged, Heat Treated Chrome Vanadium Steel
- Corrosion-Resistant Black Phosphate Finish
- Locks on to Socket and Drive Tang

| Item | Description | Packaging | Cs | In |
|------|----------------------------------|--------------------|-----|----|
| 4963 | 3-pc. Impact Universal Joint Set | SLIDE BLISTER CARD | 120 | 12 |
| 4964 | 3-pc. Impact Universal Joint Set | SLIDE BLISTER CARD | 120 | 12 |



Individual Programs

| | |
|----------------------------|-----|
| Combination wrenches | 25 |
| Files | 83 |
| Hex bit sockets | 12 |
| Impact sockets | 161 |
| Jumbo combination wrenches | 25 |

| | |
|-------------------------|-------|
| Chisels and punches | 88 |
| Power bits | 51 |
| Screwdrivers | 37 |
| Sockets and accessories | 10-11 |
| Wood chisels | 90 |

Alphabetical Index

| A | |
|---------------------------|---------------------|
| Abrasives | 118-121 |
| Adapters and reducers | 10-11, 18, 161, 169 |
| Adjustable wrenches | 26 |
| Air control units | 158-159 |
| Air die grinders | 153 |
| Air drills | 152 |
| Air hammers | 152 |
| Air hose reels | 160 |
| Air hoses | 160 |
| Air pumps | 139 |
| Air ratchets | 151 |
| Air regulators | 158-159 |
| Air tools | 150-160 |
| Aluminum pipe wrenches | 27 |
| Angle open end wrenches | 22 |
| Angle vises | 76 |
| Auto body repair tools | 126-127 |
| Auto emergency sets | 123 |
| Automotive accessories | 137 |
| Automotive spray guns | 155-156 |
| Automotive tools | 126-139 |
| Aviation snips | 66 |
| Axes | 58 |
| B | |
| Ball pein hammers | 54 |
| Bar clamps | 74 |
| Basin wrenches | 33 |
| Battery service tools | 132 |
| Battery testers | 69 |
| Bearing seperators | 129-130 |
| Bench grinder accessories | 118-119 |
| Bench vises | 76-77 |
| Bike hooks | 124 |
| Bit socket sets | 12-13, 168 |
| Bolt cutters | 61 |
| Bottle jacks | 140 |
| Bow saws | 96 |
| Box cutters | 97 |
| Brake tools | 133 |
| Breaker bars | 16 |
| Bungee cords | 146-147 |
| C | |
| Cable ties | 70 |
| Calipers | 106-107 |
| Camping and outdoor tools | 58, 96 |

| Cargo securing products | 144-147 |
|-----------------------------|---------------------|
| Caulking guns | 103 |
| C-Clamps | 75 |
| Center punches | 84-85 |
| Chipping hammers | 58 |
| Chisels | 87-90 |
| Circuit testers | 69, 132 |
| Clamps | 71-75 |
| Clean-up tools | 117 |
| Click torque wrenches | 28-29 |
| Cold chisels | 87-88 |
| Combination wrench sets | 20-24 |
| Come-alongs | 141 |
| Coping saws | 94 |
| Corner clamps | 74 |
| Countersinks | 84 |
| Couplers | 157 |
| Craft and hobby accessories | 70, 100 |
| Crimping tools & terminals | 67 |
| Cross-pein hammers | 55 |
| Crowfoot wrenches | 29 |
| Cut-off tools | 153 |
| D | |
| Dead blow hammers | 57 |
| Dent pullers | 126, 129 |
| Dial indicator | 107 |
| Die grinders | 153 |
| Double duty tarps | 149 |
| Drill bits | 110-112 |
| Drill bits and accessories | 50, 94, 110-112 |
| Drill press vises | 76 |
| Drilling hammers | 55 |
| Drills | 152 |
| Drywall hammers | 58 |
| Drywall saws | 94 |
| Dust masks | 104 |
| Dust pans | 117 |
| E | |
| Ear muffs | 104 |
| Electrical tape | 68 |
| Electrical testers | 69, 132 |
| Electrical tools | 67-70 |
| Emergency tool kits | 123 |
| Extension bars | 10-11, 17, 161, 168 |
| Eye goggles | 104 |

| F | |
|-----------------------------|--------------|
| Fencing pliers | 63 |
| Files | 81-83 |
| Finger ratchet | 15 |
| Flashlights | 123 |
| Flaring tools | 79 |
| Folding utility knives | 98 |
| Framing squares | 105 |
| Funnels | 134 |
| Furniture dolly | 117 |
| G | |
| Garage jacks | 140 |
| Gear pullers | 128-131 |
| Gluing clamps | 74 |
| Grinding stones | 119 |
| Grommets and grommet tools | 149 |
| Groove joint pliers | 61 |
| H | |
| Hacksaws | 91-93 |
| Hammers | 52-58 |
| Hardware | 124-125 |
| Hatchets | 58 |
| Hearing protection | 104 |
| Helping hand with magnifier | 70 |
| Hex key wrenches | 30-32 |
| High speed sanders | 154 |
| Hitch balls and couplers | 142 |
| Hoists | 140 |
| Hole saws | 50, 94 |
| Hollow punches | 86 |
| Hooks | 124 |
| Hose reels | 160 |
| Hydraulic jacks | 140 |
| I | |
| Impact socket accessories | 161, 168-169 |
| Impact socket adapters | 161, 169 |
| Impact sockets | 161-169 |
| Impact socket reducers | 161, 169 |
| Impact socket sets | 162-168 |
| Impact wrenches | 150-151 |
| Inspection tools | 115-116 |
| J | |
| Jacks | 140, 142 |
| Jumbo combination wrenches | 22-23, 25 |
| Jumbo ratchet/socket sets | 6-7, 14 |
| K | |
| Knee pads | 104 |
| Knives | 97-102 |
| L | |
| LED lights | 123 |
| Leather Punches | 85 |
| Letter and Number Punches | 85 |

| Load binders | 144 |
|----------------------------------|-----------|
| Locking clamps | 71 |
| Locking pliers | 66 |
| Lockout tools | 137 |
| Long reach pliers | 62 |
| Lug wrenches | 139 |
| M | |
| Machinist hammers | 55 |
| Magnetic base for dial indicator | 107 |
| Magnetic pick-up tools | 115-117 |
| Mallets | 56-57 |
| Measuring tools | 105-109 |
| Micrometer | 107 |
| Mover's dolly | 117 |
| Multi-testers | 69 |
| N | |
| Nail sets | 84 |
| Number and letter punches | 85 |
| Nut drivers | 15, 49 |
| Nut splitter | 114 |
| O | |
| "O"-rings | 124 |
| Offset box ratchet wrenches | 24 |
| Offset screwdrivers | 41 |
| Oil filter wrenches | 134 |
| P | |
| Padlocks | 125 |
| Paint brushes | 103 |
| Paint spray guns | 155 |
| Palm ratchet | 15 |
| Parts cleaning brush | 135 |
| Parts trays | 19 |
| Pick and hook sets | 136 |
| Pick-up tools | 115-117 |
| Pipe cutters | 78 |
| Pipe threaders | 79 |
| Pipe wrenches | 27 |
| Pliers | 61-66 |
| Pneumatic tools | 150-160 |
| Power driver bit sets | 42-51 |
| Power nut drivers | 49 |
| Power pullers | 141 |
| Precision measuring tools | 106-107 |
| Precision pliers | 63 |
| Precision screwdrivers | 38-39, 43 |
| Protective equipment | 104 |
| Pry bars | 59-60 |
| Punches | 84-88 |
| Putty knives | 102 |
| R | |
| Ratchet bar clamps | 74 |
| Ratchet and socket sets | 2-6 |
| Ratchet tie downs | 144-145 |

| | |
|----------------------------|---------------------|
| Ratchets | 14-15 |
| Reducers and adapters | 10-11, 18, 161, 169 |
| Respiratory protection | 104 |
| Retractable air hose reels | 160 |
| Rivet guns | 80 |
| Rubber mallets | 56-57 |
| Rubber tie downs | 146 |
| S | |
| Sabre saws | 95 |
| Safety equipment | 104 |
| Safety glasses | 104 |
| Safety scrapers | 97, 101 |
| Safety tape | 104 |
| Sandpaper | 120 |
| Sandblasters | 156 |
| Sanders | 154 |
| Saws | 91-96 |
| Screwdriver bit sets | 42-50 |
| Screwdriver sets | 34-46 |
| Screwdrivers | 34-50 |
| Screw extractors | 114 |
| Sharpening stones | 119 |
| Sledge hammers | 55 |
| Slide hammer pullers | 126, 129 |
| Slip joint pliers | 61 |
| Snap-off knives | 97 |
| Snap ring pliers | 65 |
| Socket holders | 19 |
| Socket sets | 2-9, 12-13 |
| Soft mallets | 56-57 |
| Soldering irons | 68 |
| Spark plug tools | 132-135 |
| Spray guns | 155 |
| Spring clamps | 72-73 |
| Squares | 105 |
| Standard duty tarps | 148 |
| Staple guns | 80 |
| Storage hooks | 124 |
| T | |
| Tack hammers | 52 |

| | |
|-----------------------------|--------------|
| Tack pullers | 37, 59 |
| Tap & die sets | 113-114 |
| Tape | 68, 104, 157 |
| Tape measures | 109 |
| Tarp repair | 149 |
| Tarps | 148-149 |
| Thread sealing tape | 157 |
| Tie downs | 144-147 |
| Tin snips | 66 |
| Tire gauges | 138-139 |
| Tire pumps | 139 |
| Tire repair tools | 139 |
| Tire service tools | 138-139 |
| Torque wrenches | 28-29 |
| Towing | 142-143 |
| Tow ropes and straps | 143 |
| Trailer jacks | 142 |
| Tubing benders | 79 |
| Tubing cutters | 78 |
| Tweezers | 70 |
| U | |
| Universal joints | 10-11, 18 |
| Utility hooks | 124 |
| Utility knives and scrapers | 97-101 |
| V | |
| Vises | 76-77 |
| W | |
| Welding accessories | 58, 71, 77 |
| Welding clamps | 71 |
| Winches | 141 |
| Wire brushes | 118, 120-121 |
| Wire strippers | 67 |
| Wire wheels | 118 |
| Wood carving chisels | 89 |
| Wood chisels | 89-90 |
| Woodworking vises | 76 |
| Wrecking bars | 59 |
| Wrench holders | 33 |
| Wrenches | 20-33 |

40 YEARS STRONG



**MICHIGAN
INDUSTRIAL
TOOLS**

®

For more than 40 years, Michigan Industrial Tools has been a leading hand tool company, supplying major retail chains, automotive centers, and independent hardware, lumber, and farm supply stores. Our comprehensive product line contains over 2000 different SKUs for the consumer, professional, and automotive markets. Nearly all of our products carry a Lifetime Replacement, Time Period, or Quality Guarantee and meet or exceed ANSI specifications.

Experience.
Quality processes.
Innovative products.
And personal service.

ALSO
AVAILABLE
FROM



MICHIGAN
INDUSTRIAL
TOOLS

REV IT UP™

Rev up your tool business with MAXCRAFT from Michigan Industrial Tools. Full of innovative features that make work easier, each product is built to last according to strict quality control guidelines. Backed by flexible ordering plans and full merchandising support, the MAXCRAFT program has rolled out to 2,500 stores across the country. Order now, and get ready for MAXCRAFT to rev it up.



MAXCRAFT

www.getmaxcraft.com

TEKTON

www.gettekton.com

Arriving
FALL 2010

TOOLS YOU NEED™

WorkShop stands apart. An innovation in impulse table merchandising, WorkShop offers style and value, attracting both bargain and brand-conscious shoppers. Packed with 500+ value-priced SKUs, available through several standard or customized ordering options, and fully supported by our merchandising staff, WorkShop gives you the tools you need to maximize your impulse program profits.



WorkShop™

www.getworkshop.com



Get more from Michigan Industrial Tools

www.mit-tool.com

MIT home page

Corporate and product brand overview



Order online



- Faster, more accurate, with less waste
- Simplify ordering with the complete, at-a-glance record of your current invoice, purchase history, current balance and more

TEKTON® home page

- Get more info about TEKTON®
- Download product catalogs

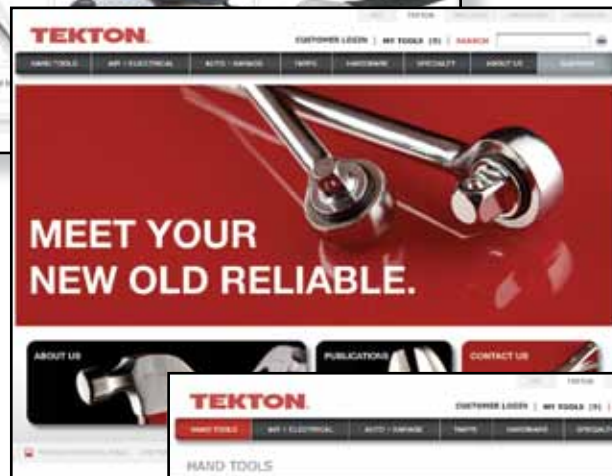

TEKTON® product line

- Overview of complete product line with simple, organized menus and quick-search feature

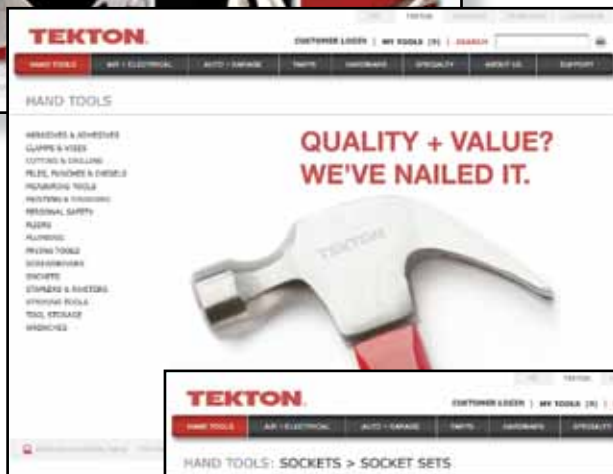

TEKTON® product detail

- Complete product information and specifications





TEKTON®

Everyday, do-it-yourself tools — over 1,500 SKUs. Backed by a lifetime replacement or quality guarantee, TEKTON tools are reliable, superior-quality, affordable tools with an appealing retail presence.



MEET YOUR NEW OLD RELIABLE™



TEKTON®

Michigan Industrial Tools
3707 Roger B. Chaffee Drive SE
Grand Rapids, MI 49548

Phone: (616) 243-2443 • Toll-Free: (888) 648-8665 • Fax: (616) 243-6648
E-mail: info@mit-tool.com • www.mit-tool.com

Get the latest TEKTON® information at
www.gettektion.com