

TAKE IT ON.

2012
CATALOG



TEKTON
[®]



Sockets and Ratchets	2-19
Wrenches	20-33
Screwdrivers	34-49
Striking Tools	50-55
Prying Tools	56-57
Pliers and Snips	58-66
Electrical Tools	67-70
Clamps	71-74
Vises	75
Plumbing	76-77
Files	78-79
Punches and Chisels	80-85
Saws	86-90
Knives	91-97
Painting	98
Safety Equipment	99
Measuring Tools	100-103
Drill Bits	104-105
Tap and Die	106-107
Pick-Up and Inspection Tools	108-111
Abrasives and Wire Brushes	112-114
Tool Sets	115-117
LED Lights	118-119
Hardware	120-121
Automotive Tools	122-133
Lifting and Pulling	134-135
Towing	136-139
Cargo Securing Products	140-143
Tarps	144-145
Air Tools	146-156
Impact Sockets	157-165



TEKTON®

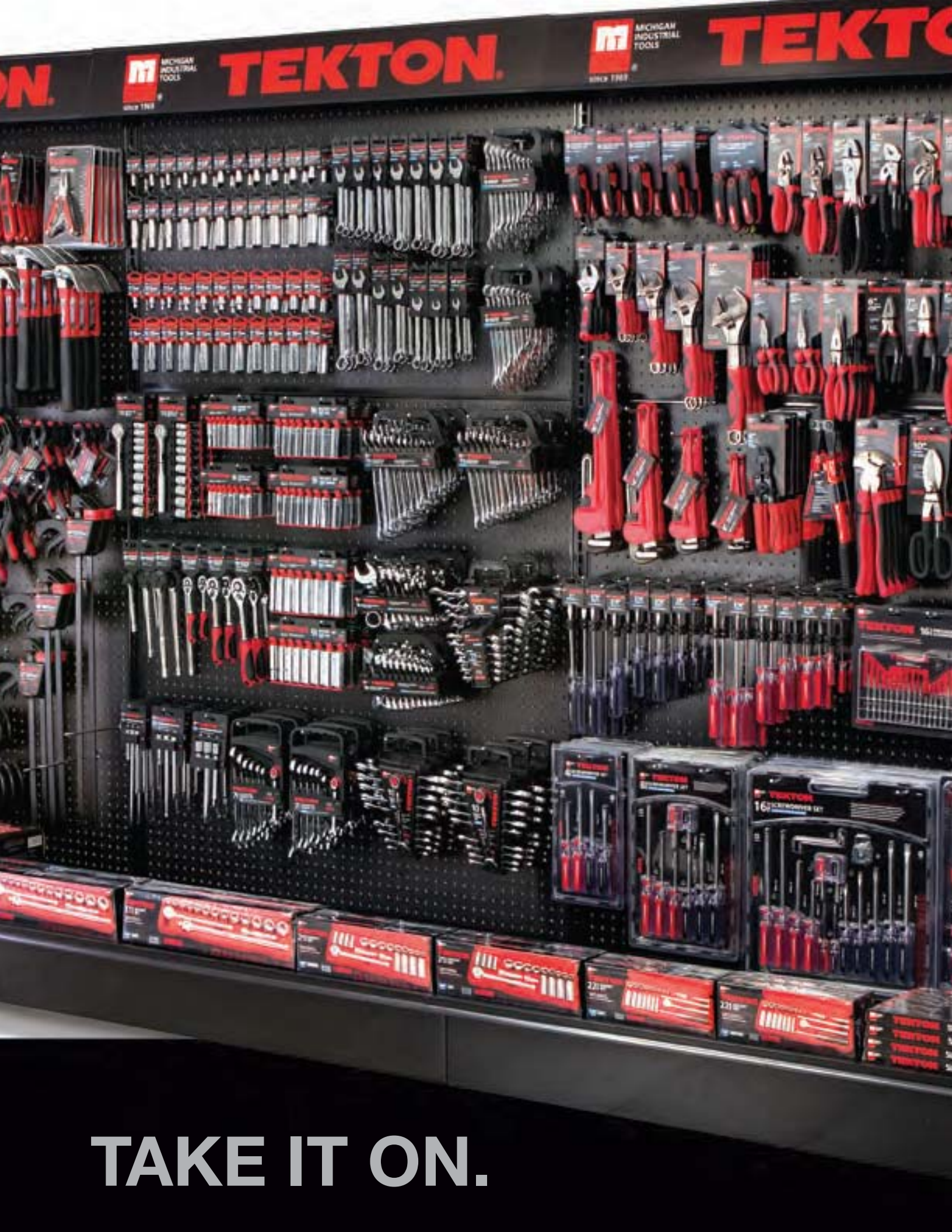

M MICHIGAN INDUSTRIAL TOOLS
SINCE 1987

TEKTON.

M MICHIGAN INDUSTRIAL TOOLS
SINCE 1987

TEKTON

TAKE IT ON.



40-pc. 1/4" and 3/8" Drive Socket Set (SAE/Metric)

- Drop Forged Carbon Steel Ratchets, Sockets and Extensions
- Durable Chrome Plated Finish Resists Corrosion
- Tapered-End 6-Point Sockets
- Reversible-Drive Ratchet Handle with Lock-On Ball Bearing and Non-Slip Knurled Grip
- 12-pc. 1/4" Dr. 6-Point Sockets (SAE): 5/32, 3/16, 7/32, 1/4, 9/32, 5/16, 11/32, 3/8, 13/32, 7/16, 15/32, 1/2"
- 12-pc. 1/4" Dr. 6-Point Sockets (Metric): 4, 4.5, 5, 5.5, 6, 7, 8, 9, 10, 11, 12, 13mm
- 3-pc. 3/8" Dr. 6-Point Sockets (SAE): 7/16, 1/2, 5/8"
- 3-pc. 3/8" Dr. 6-Point Sockets (Metric): 12, 14, 16mm
- 1-pc. 3/8" Dr. x 8" Reversible Ratchet
- 1-pc. 3/8" Dr. x 3" Extension Bar
- 1-pc. 1/4" Dr. (M) x 3/8" Dr. (F) Adapter
- 1-pc. 1/4" Dr. x 6" Spinner Handle
- 1-pc. 3/8" Dr. x 5/8" 6-Point Spark Plug Socket
- 1-pc. 3/8" Dr. Speed Disc
- 3-pc. 1/4" Dr. 8-Point Sockets: 1/4, 5/16, 3/8"
- 1-pc. Storage Case

Item	Description	Packaging	Cs	In
1005	40-pc. 1/4" and 3/8" Drive Socket Set (SAE/Metric)	Color Box	10	1



40-pc. 1/4" and 3/8" Drive Socket Set (SAE/Metric)

- Drop Forged Carbon Steel Ratchets, Sockets and Extensions
- Durable Chrome Plated Finish Resists Corrosion
- Tapered-End 6-Point Sockets
- Reversible-Drive Ratchet Handle with Lock-On Ball Bearing and Non-Slip Knurled Grip
- 14-pc. 1/4" Dr. 6-Point Sockets (SAE): 5/32, 3/16, 7/32, 1/4, 9/32, 5/16, 11/32, 3/8, 13/32, 7/16, 15/32, 1/2, 17/32, 9/16"
- 14-pc. 1/4" Dr. 6-Point Sockets (Metric): 4, 4.5, 5, 5.5, 6, 6.5, 7, 7.5, 8, 9, 10, 11, 12, 13 mm
- 3-pc. 1/4" Dr. 8-Point Sockets (SAE): 1/4, 5/16, 3/8"
- 2-pc. 3/8" Dr. 6-Point Sockets (SAE): 5/8, 11/16"
- 2-pc. 3/8" Dr. 6-Point Sockets (Metric): 14, 15 mm
- 1-pc. 3/8" Dr. x 8" Reversible Ratchet Handle
- 1-pc. 3/8" Dr. x 3" Extension Bar
- 1-pc. 1/4" Dr. (M) x 3/8" Dr. (F) Adapter
- 1-pc. 3/8" Dr. Speed Disc
- Complete with Storage Case

Item	Description	Packaging	Cs	In
1012	40-pc. 1/4" and 3/8" Drive Socket Set (SAE/Metric)	Color Box	10	1

52-pc. 1/4", 3/8", 1/2" Drive Socket Set (SAE/Metric)

- Drop Forged Carbon Steel Ratchets, Sockets and Extensions
- Durable Chrome Plated Finish Resists Corrosion
- Tapered-End 6-Point Sockets
- Reversible-Drive Ratchet Handles with Lock-On Ball Bearing and Non-Slip Knurled Grip



- 1-pc. 1/2" Dr. x 10" Rev. Ratchet Handle
- 1-pc. 3/8" Dr. x 8" Rev. Ratchet Handle
- 1-pc. 3/8" Dr. x 3" Extension Bar
- 1-pc. 1/4" Dr.(M) x 3/8" Dr.(F) Adapter
- 1-pc. 1/4" Dr. x 6" Spinner Handle
- 2-pc. 3/8" and 1/2" Dr. Speed Discs
- 1-pc. 3/8" Dr. x 5/8" Spark Plug Socket
- 12-pc. 1/4" Dr. 6-Point Sockets (SAE): 5/32, 3/16, 7/32, 1/4, 9/32, 5/16, 11/32, 3/8, 13/32, 7/16, 15/32, 1/2"
- 3-pc. 1/4" Dr. 8-Point Sockets (SAE): 1/4, 5/16, 3/8"
- 12-pc. 1/4" Dr. 6-Point Sockets (Metric): 4, 4.5, 5, 5.5, 6, 7, 8, 9, 10, 11, 12, 13mm
- 3-pc. 3/8" Dr. 6-Point Sockets (SAE): 9/16, 11/16, 3/4"
- 3-pc. 3/8" Dr. 6-Point Sockets (Metric): 14, 16, 17mm
- 10-pc. 1/2" Dr. 6-Point Sockets (SAE): 3/8, 13/32, 7/16, 15/32, 1/2, 9/16, 5/8, 11/16, 25/32, 13/16"
- 1-pc. Storage Case

Item	Description	Packaging	Cs	In
1035	52-pc. 1/4", 3/8", 1/2" Drive Socket Set (SAE/Metric)	Color Sleeve	5	1

25-pc. 1/2" Drive Socket Set (SAE)

- Drop Forged Carbon Steel Ratchets, Sockets and Extensions
- Durable Chrome Plated Finish Resists Corrosion
- Tapered-End 6-Point Sockets
- Reversible-Drive Ratchet Handle and Speed Handle with Lock-On Ball Bearing and Non-Slip Knurled Grip
- 1-pc. 10" Rev. Ratchet Handle
- 1-pc. 5" Extension Bar
- 1-pc. 10" Extension Bar
- 1-pc. 16-1/2" Speed Handle
- 1-pc. Speed Disc
- 1-pc. 5/8" Spark Plug Socket
- 18-pc. 1/2" Dr. 6-Point Sockets (SAE): 3/8, 7/16, 15/32, 1/2, 9/16, 19/32, 5/8, 21/32, 11/16, 23/32, 3/4, 25/32, 13/16, 7/8, 15/16, 1, 1-1/8, 1-1/4"
- 1-pc. Storage Case



Item	Description	Packaging	Cs	In
1040	25-pc. 1/2" Drive Socket Set (SAE)	Color Sleeve	5	1

11-pc. 3/8" Drive Socket Sets

- Drop Forged, Heat Treated Chrome Vanadium Steel
- Corrosion-Resistant, Chrome Plated Finish
- Tapered-End, 6-Point Sockets with Notched, Lock-On Drive End
- Knurled-Grip Ratchet Handle with Lock-On Drive Tang
- Meets or Exceeds ANSI Standards

1816

- 1-pc. 8" Ratchet Handle
- 10-pc. 3/8" Dr. 6-Point Sockets (SAE): 3/8, 7/16, 15/32, 1/2, 9/16, 5/8, 11/16, 3/4, 13/16, 7/8"

1817

- 1-pc. 8" Ratchet Handle
- 10-pc. 3/8" Dr. 6-Point Sockets (Metric): 10, 11, 12, 13, 14, 15, 16, 17, 18, 19mm

Item	Description	Packaging	Cs	In
1816	11-pc. 3/8" Drive Socket Set (SAE)	Plastic Hang Rack/Label	24	6
1817	11-pc. 3/8" Drive Socket Set (Metric)	Plastic Hang Rack/Label	24	6

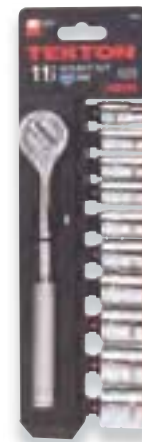

1816

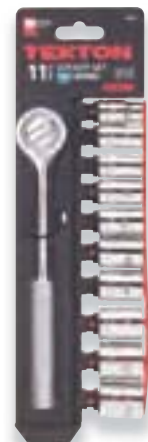

1817

11-pc. 1/2" Drive Socket Sets

- Drop Forged, Heat Treated Chrome Vanadium Steel
- Corrosion-Resistant, Chrome Plated Finish
- Tapered-End, 6-Point Sockets with Notched, Lock-On Drive End
- Knurled-Grip Ratchet Handle with Lock-On Drive Tang
- Meets or Exceeds ANSI Standards

1818

- 1-pc. 10" Ratchet Handle
- 10-pc. 1/2" Dr. 6-Point Sockets (SAE): 3/8, 7/16, 15/32, 1/2, 9/16, 5/8, 11/16, 3/4, 13/16, 7/8"

1819

- 1-pc. 10" Ratchet Handle
- 10-pc. 1/2" Dr. 6-Point Sockets (Metric): 10, 11, 12, 13, 14, 15, 16, 17, 18, 19mm

Item	Description	Packaging	Cs	In
1818	11-pc. 1/2" Drive Socket Set (SAE)	Plastic Hang Rack/Label	24	6
1819	11-pc. 1/2" Drive Socket Set (Metric)	Plastic Hang Rack/Label	24	6



1818



1819

22-pc. 1/4" Drive Socket Sets



- Forged and Hardened Chrome Vanadium Steel
- Corrosion-Resistant Chrome Plated Finish
- Tapered-End 6-Point Sockets
- Notched Sockets Lock onto Ratchets and Extensions with Spring-Loaded Ball Bearing Retainer
- Meets or Exceeds ANSI Standards

11451

- 1-pc. 1/4" Dr. x 5" Ratchet Handle
- 2-pc. Extension Bars: 2" and 6"
- 1-pc. 6" Spinner Handle
- 1-pc. Universal Joint
- 9-pc. 1/4" Dr. 6-Point Sockets: 3/16, 7/32, 1/4, 9/32, 5/16, 11/32, 3/8, 7/16, 1/2"
- 7-pc. 1/4" Dr. 6-Point Deepwell Sockets: 1/4, 9/32, 5/16, 11/32, 3/8, 7/16, 1/2"
- 1-pc. Storage Case

11501

- 1-pc. 1/4" Dr. x 5" Ratchet Handle
- 2-pc. Extension Bars: 2" and 6"
- 1-pc. 6" Spinner Handle
- 1-pc. Universal Joint
- 9-pc. 1/4" Dr. 6-Point Sockets: 4, 5, 5.5, 6, 7, 8, 9, 10, 11mm
- 7-pc. 1/4" Dr. 6-Point Deepwell Sockets: 5.5, 6, 7, 8, 9, 10, 11mm
- 1-pc. Storage Case

Item	Description	Packaging	Cs	In
11451	22-pc. 1/4" Drive Socket Set (SAE)	Color Box	10	1
11501	22-pc. 1/4" Drive Socket Set (Metric)	Color Box	10	1

21-pc. 3/8" Drive Socket Sets



- Forged and Hardened Chrome Vanadium Steel
- Corrosion-Resistant Chrome Plated Finish
- Tapered-End 6-Point Sockets
- Notched Sockets Lock onto Ratchets and Extensions with Spring-Loaded Ball Bearing Retainer
- Meets or Exceeds ANSI Standards

11551

- 1-pc. 3/8" Dr. x 8" Ratchet Handle
- 2-pc. Extension Bars: 1-3/4" and 3"
- 9-pc. 3/8" Dr. 6-Point Sockets (SAE): 3/8, 7/16, 1/2, 9/16, 5/8, 11/16, 3/4, 13/16, 7/8"
- 8-pc. 3/8" Dr. 6-Point Deepwell Sockets (SAE): 3/8, 7/16, 1/2, 9/16, 5/8, 11/16, 3/4, 13/16"
- 1-pc. Storage Case

11601

- 1-pc. 3/8" Dr. x 8" Ratchet Handle
- 2-pc. Extensions Bars: 1-3/4" and 3"
- 9-pc. 3/8" Dr. 6-Point Sockets: 9, 10, 11, 12, 13, 14, 15, 17, 19mm
- 8-pc. 3/8" Dr. 6-Point Deepwell Sockets: 10, 11, 12, 13, 14, 15, 17, 19mm
- 1-pc. Storage Case

Item	Description	Packaging	Cs	In
11551	21-pc. 3/8" Drive Socket Set (SAE)	Color Box	10	1
11601	21-pc. 3/8" Drive Socket Set (Metric)	Color Box	10	1

17-pc. 1/2" Drive Socket Sets



- Forged and Hardened Chrome Vanadium Steel
- Corrosion-Resistant Chrome Plated Finish
- Tapered-End 6-Point Sockets
- Notched Sockets Lock onto Ratchets and Extensions with Spring-Loaded Ball Bearing Retainer
- Meets or Exceeds ANSI Standards

11651

- 1-pc. 1/2" Dr. x 10" Ratchet Handle
- 1-pc. 5" Extension Bar
- 1-pc. 14" Flex Breaker Bar
- 13-pc. 1/2" Dr. 6-Point Sockets: 7/16, 1/2, 9/16, 5/8, 11/16, 3/4, 13/16, 7/8, 15/16, 1, 1-1/16, 1-1/8, 1-1/4"
- 1-pc. Storage Case

11701

- 1-pc. 1/2" Dr. x 10" Ratchet Handle
- 1-pc. 5" Extension Bar
- 1-pc. 14" Flex Breaker Bar
- 13-pc. 1/2" Dr. 6-Point Sockets (Metric): 10, 11, 12, 13, 14, 17, 19, 20, 21, 22, 23, 24, 27mm
- 1-pc. Storage Case

Item	Description	Packaging	Cs	In
11651	17-pc. 1/2" Drive Socket Set (SAE)	Color Box	6	1
11701	17-pc. 1/2" Drive Socket Set (Metric)	Color Box	6	1

60-pc. 1/4", 3/8", and 1/2" Drive Socket Sets

- Forged and Hardened Chrome Vanadium Steel
- Corrosion-Resistant Chrome Plated Finish
- Tapered-End 6-Point Sockets
- Notched Sockets Lock onto Ratchets and Extensions with Spring-Loaded Ball Bearing Retainer
- Meets or Exceeds ANSI Standards

11761

- 1-pc. 1/4" Dr. x 5-1/2" Ratchet Handle
- 1-pc. 3/8" Dr. x 8" Ratchet Handle
- 1-pc. 1/2" Dr. x 10" Ratchet Handle
- 3-pc. Speed Discs: 1/4" Dr., 3/8" Dr., 1/2" Dr.
- 1-pc. 1/2" Dr. x 17" Flex Breaker Bar
- 2-pc. 1/4" Dr. Extension Bars: 2" and 4"
- 2-pc. 3/8" Dr. Extension Bars: 1-3/4" and 3"
- 1-pc. 1/2" Dr. Extension Bar: 5"
- 1-pc. 1/4" Dr. x 6" Spinner Handle
- 1-pc. 1/4" Dr. Universal Joint
- 9-pc. 1/4" Dr. 6-Point Sockets (SAE): 3/16, 7/32, 1/4, 9/32, 5/16, 11/32, 3/8, 7/16, 1/2"
- 7-pc. 1/4" Dr. Deepwell 6-Point Sockets (SAE): 1/4, 9/32, 5/16, 11/32, 3/8, 7/16, 1/2"
- 9-pc. 3/8" Dr. 6-Point Sockets (SAE): 3/8, 7/16, 1/2, 9/16, 5/8, 11/16, 3/4, 13/16, 7/8"
- 8-pc. 3/8" Dr. Deepwell 6-Point Sockets (SAE): 3/8, 7/16, 1/2, 9/16, 5/8, 11/16, 3/4, 13/16"
- 13-pc. 1/2" Dr. 6-Point Sockets (SAE): 7/16, 1/2, 9/16, 5/8, 11/16, 3/4, 13/16, 7/8, 15/16, 1", 1-1/16, 1-1/8, 1-1/4"
- 1-pc. Storage Case

11811

- 1-pc. 1/4" Dr. x 5-1/2" Ratchet Handle
- 1-pc. 3/8" Dr. x 8" Ratchet Handle
- 1-pc. 1/2" Dr. x 10" Ratchet Handle
- 3-pc. Speed Discs: 1/4" Dr., 3/8" Dr., 1/2" Dr.
- 1-pc. 1/2" Dr. x 17" Flex Breaker Bar
- 2-pc. 1/4" Dr. Extension Bars: 2" and 4"
- 2-pc. 3/8" Dr. Extension Bars: 1-3/4" and 3"
- 1-pc. 1/2" Dr. Extension Bar: 5"
- 1-pc. 1/4" Dr. x 6" Spinner Handle
- 1-pc. 1/4" Dr. Universal Joint
- 9-pc. 1/4" Dr. 6-Point Sockets (Metric): 4, 5, 5.5, 6, 7, 8, 9, 10, 11mm
- 7-pc. 1/4" Dr. Deepwell 6-Point Sockets (Metric): 5.5, 6, 7, 8, 9, 10, 11mm
- 9-pc. 3/8" Dr. 6-Point Sockets (Metric): 9, 10, 11, 12, 13, 14, 15, 17, 19mm
- 8-pc. 3/8" Dr. Deepwell 6-Point Sockets (Metric): 10, 11, 12, 13, 14, 15, 17, 19mm
- 13-pc. 1/2" Dr. 6-Point Sockets (Metric): 10, 11, 12, 13, 14, 17, 19, 20, 21, 22, 23, 24, 27mm
- 1-pc. Storage Case



Item	Description	Packaging	Cs	In
11761	60-pc. 1/4", 3/8", 1/2" Drive Socket Set (SAE)	Color Box	3	1
11811	60-pc. 1/4", 3/8", 1/2" Drive Socket Set (Metric)	Color Box	3	1

21-pc. 3/4" Drive Jumbo Socket Sets

- Drop Forged, Heat Treated Carbon Steel Construction
- Corrosion-Resistant Chrome Plated Finish
- Tapered-End, 6-Point Sockets with Notched Drive End Lock onto Ratchets and Extensions
- Ratchet Handle and Breaker Bar with Socket-Retaining Drive Tang and Non-Slip, Knurled Handle Grip

1100

- 1-pc. 3/4" Drive 19-1/2" Ratchet Handle
- 1-pc. 3/4" Drive 18" Flex Breaker Bar
- 2-pc. 3/4" Drive Extension Bars: 4", 8"
- 17-pc. 3/4" Drive 6-Point Sockets (Metric): 19, 22, 24, 26, 27, 28, 30, 32, 34, 36, 38, 41, 42, 45, 46, 48, 50mm
- Complete with Carry Case

1115

- 1-pc. 3/4" Drive 19-1/2" Ratchet Handle
- 1-pc. 3/4" Drive 18" Flex Breaker Bar
- 2-pc. 3/4" Drive Extension Bars: 4", 8"
- 16-pc. 3/4" Drive 6-Point Sockets (SAE): 7/8", 15/16", 1", 1-1/16", 1-1/8", 1-3/16", 1-1/4", 1-5/16", 1-3/8", 1-7/16", 1-1/2", 1-5/8", 1-3/4", 1-13/16", 1-7/8", 2"
- 1-pc. Carry Case

Item	Description	Packaging	Cs	In
1100	21-pc. 3/4" Drive Jumbo Socket Set (Metric)	Color Box	2	1
1115	21-pc. 3/4" Drive Jumbo Socket Set (SAE)	Color Box	2	1





26-pc. 3/4" and 1" Drive Jumbo Socket Set (SAE)

- Drop Forged, Heat Treated Manganese Ratchets, Sockets and Extensions
- Durable Sandblasted Finish
- Tapered 12-Point Socket Ends for Easy Access to Nuts and Bolts
- Notches in Sockets Lock onto Ratchets and Extensions
- Knurled Pattern on Ratchet Handles Provides Excellent Gripping Power
- Spring Loaded Ball Bearing Locks Sockets Securely in Position
- Features a Heavy Duty Metal Carry Case for Organized Storage of All Components
- 1-pc. 3/4" Dr. Ratchet Head
- 1-pc. 3/4" Dr. x 21" Breaker Bar Handle
- 1-pc. 3/4" Dr. x 21" Extension Bar
- 1-pc. 3/4" Dr. x 8" Extension Bar
- 1-pc. 3/4" Dr. (F) x 1" Dr. (M) Adapter
- 1-pc. Sliding T-Bar Adapter
- 17-pc. 3/4" Dr. 12-Point Sockets (SAE): 15/16, 1, 1-1/16, 1-1/8, 1-1/4, 1-3/16, 1-5/16, 1-3/8, 1-7/16, 1-1/2, 1-5/8, 1-11/16, 1-3/4, 1-13/16, 1-7/8, 2"
- 3-pc. 1" Dr. 12-Point Sockets (SAE): 2-1/4, 2-1/2, 2-3/4"
- Complete with Steel Carry Case

Item	Description	Packaging	Cs	In
1118	26-pc. 3/4" and 1" Drive Jumbo Socket Set (SAE)	Plain Box/UPC	1	1



21-pc. 1" Drive Jumbo Socket Set (SAE)

- Drop Forged, Heat Treated Carbon Steel Construction
- Corrosion-Resistant Chrome Plated Finish
- Tapered-End, 12-Point Sockets with Lock-On Notched Drive End
- 43-Tooth, Knurled-Grip Ratchet Handle with Lock-On Drive Tang
- 1-pc. 1" Drive 25" Ratchet Handle
- 1-pc. 1" Drive 22" Sliding T-Head Breaker Bar
- 1-pc. 1" Drive 8" Extension Bar
- 1-pc. 1" Drive 18" Extension Bar
- 16-pc. 1" Drive 12-Point Sockets (SAE): 1-5/8", 1-11/16", 1-3/4", 1-13/16", 1-7/8", 2", 2-1/8", 2-3/16", 2-1/4", 2-3/8", 2-1/2", 2-5/8", 2-3/4", 2-15/16", 3", 3-1/8"
- 1-pc. Steel Carry Case

Item	Description	Packaging	Cs	In
1120	21-pc. 1" Drive Jumbo Socket Set (SAE)	Color Label	1	1

CARBON STEEL



8-pc. 3/4" Drive Jumbo Socket Set (2-1/16"-2-1/2") Carbon Steel

- Drop Forged, Heat Treated Carbon Steel Construction
- Corrosion-Resistant Chrome Plated Finish
- Tapered-End, 12-Point Sockets
- Notched End Locks onto Drive Tang
- 8-pc. 3/4" Drive Sockets - 12-point (SAE): 2-1/16", 2-1/8", 2-3/16", 2-1/4", 2-5/16", 2-3/8", 2-7/16", 2-1/2"
- 1-pc. Carry Case

Item	Description	Packaging	Cs	In
1110	8-pc. 3/4" Drive Jumbo Socket Set (2-1/16"-2-1/2") Carbon Steel	Color Box	2	1

10-pc. 1/4" and 3/8" Drive Star Socket Set (E4-E18) Cr-V

- Drop Forged, Heat Treated Chrome Vanadium Steel
- Corrosion-Resistant, Chrome-Plated Finish
- Notched Drive Locks onto Ratchet or Extension
- Tapered-End Star Drive Sockets
- 5-pc. 1/4" Dr. Star Sockets: E4, E5, E6, E7, E8
- 5-pc. 3/8" Dr. Star Sockets: E10, E12, E14, E16, E18
- 1-pc. Storage Rail

CHROME VANADIUM



Item	Description	Packaging	Cs	In
1355	10-pc. 1/4" and 3/8" Drive Star Socket Set (E4-E18) Cr-V	Slide Blister Card	48	6

3/8" Drive Socket Sets

- Drop Forged Carbon Steel Construction
- Corrosion-Resistant, Chrome Plated Finish
- Tapered-End 6-Point Sockets

1814

- 12-pc. 3/8" Dr. 6-Point Sockets (SAE): 5/16, 11/32, 3/8, 13/32, 7/16, 15/32, 1/2, 9/16, 19/32, 5/8, 11/16, 3/4"
- 1-pc. Storage Rail

1815

- 12-pc. 3/8" Dr. 6-Point Sockets (Metric): 8, 9, 10, 11, 12, 13, 14, 15, 16, 17, 18, 19mm
- 1-pc. Storage Rail

CARBON STEEL



Item	Description	Packaging	Cs	In
1814	12-pc. 3/8" Drive Socket Set (5/16"-3/4") Carbon Steel	Slide Blister Card	36	6
1815	12-pc. 3/8" Drive Socket Set (8-19mm) Carbon Steel	Slide Blister Card	36	6

8 Socket Sets



1201



1202

1/4" Drive Socket Sets

- Drop Forged, Heat Treated Chrome Vanadium Steel
- Corrosion-Resistant Chrome Plated Finish
- Tapered-End 6-Point Sockets for Exact Fit
- Notched Drive Locks onto Ratchet or Extension

1201

- 9-pc. 1/4" Dr. 6-Point Sockets (SAE): 3/16", 7/32", 1/4", 9/32", 5/16", 11/32", 3/8", 7/16", 1/2"
- 1-pc. Storage Rack

1202

- 9-pc. 1/4" Dr. 6-Point Sockets (Metric): 4, 5, 6, 7, 8, 9, 10, 11, 12mm
- 1-pc. Storage Rack

Item	Description	Packaging	Cs	In
1201	1/4" Drive Socket Set (3/16"-1/2") Cr-V	Plastic Hang Rack/Label	40	10
1202	1/4" Drive Socket Set (4-12mm) Cr-V	Plastic Hang Rack/Label	40	10



1203



1204

3/8" Drive Socket Sets

- Drop Forged, Heat Treated Chrome Vanadium Steel
- Corrosion-Resistant Chrome Plated Finish
- Versatile, Tapered-End, 12-Point Sockets Fit Hex and Square Head Nuts and Bolts
- Notched Drive Locks onto Ratchet or Extension

1203

- 10-pc. 3/8" Dr. 12-Point Sockets (SAE): 5/16", 3/8", 7/16", 1/2", 9/16", 5/8", 11/16", 3/4", 13/16", 7/8"
- 1-pc. Storage Rack

1204

- 10-pc. 3/8" Dr. 12-Point Sockets (Metric): 10, 11, 12, 13, 14, 15, 16, 17, 18, 19mm
- 1-pc. Storage Rack

Item	Description	Packaging	Cs	In
1203	3/8" Drive Socket Set (5/16"-7/8") Cr-V	Plastic Hang Rack/Label	20	10
1204	3/8" Drive Socket Set (10-19mm) Cr-V	Plastic Hang Rack/Label	20	10



1205

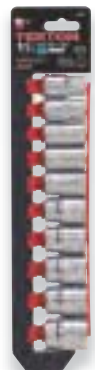

1206

1/2" Drive Socket Sets

- Drop Forged, Heat Treated Chrome Vanadium Steel
- Corrosion-Resistant Chrome Plated Finish
- Versatile, Tapered-End, 12-Point Sockets Fit Hex and Square Head Nuts and Bolts
- Notched Drive Locks onto Ratchet or Extension

1205

- 10-pc. 1/2" Dr. 12-Point Sockets (SAE): 3/8", 7/16", 1/2", 9/16", 5/8", 11/16", 3/4", 13/16", 7/8", 15/16"
- 1-pc. Storage Rack

1206

- 10-pc. 1/2" Dr. 12-Point Sockets (Metric): 13, 14, 15, 16, 17, 18, 19, 21, 22, 24mm
- 1-pc. Storage Rack

Item	Description	Packaging	Cs	In
1205	1/2" Drive Socket Set (3/8"-15/16") Cr-V	Plastic Hang Rack/Label	20	10
1206	1/2" Drive Socket Set (13-24mm) Cr-V	Plastic Hang Rack/Label	20	10

1215



1220



1/4" Drive Deep Socket Sets

- Drop Forged Carbon Steel Construction
- Corrosion-Resistant Chrome Plated Finish
- Notched Drive Locks onto Ratchet or Extension
- Tapered-End 6-Point Sockets

1215

- 8-pc. 1/4" Dr. Deepwell 6-Point Sockets (SAE): 3/16, 7/32, 1/4, 9/32, 5/16, 11/32, 3/8, 7/16"
- 1-pc. Storage Rack

1220

- 8-pc. 1/4" Dr. Deepwell 6-Point Sockets (Metric): 5.5, 6, 7, 8, 9, 10, 11, 12mm
- 1-pc. Storage Rack

Item	Description	Packaging	Cs	In
1215	1/4" Dr. Deep Socket Set (3/16"-7/16") Carbon Steel	Plastic Hang Rack/Label	40	10
1220	1/4" Dr. Deep Socket Set (5.5-12mm) Carbon Steel	Plastic Hang Rack/Label	40	10

3/8" Drive Deep Socket Sets

- Drop Forged Carbon Steel Construction
- Corrosion-Resistant Chrome Plated Finish
- Notched Drive Locks onto Ratchet or Extension
- Tapered-End 6-Point Sockets

1225

- 8-pc. 3/8" Dr. Deepwell 6-Point Sockets (SAE): 3/8, 7/16, 1/2, 9/16, 5/8, 11/16, 3/4, 13/16"
- 1-pc. Storage Rack

Item	Description	Packaging	Cs	In
1225	3/8" Dr. Deep Socket Set (3/8"-13/16") Carbon Steel	Plastic Hang Rack/Label	20	10
1230	3/8" Dr. Deep Socket Set (10-19mm) Carbon Steel	Plastic Hang Rack/Label	20	1

CARBON STEEL



1225

1230

- 8-pc. 3/8" Dr. Deepwell 6-Point Sockets (Metric): 10, 11, 12, 13, 14, 15, 17, 19mm
- 1-pc. Storage Rack



1230

3/8" Drive Deep Socket Sets

- Drop Forged, Heat Treated Chrome Vanadium Steel
- Corrosion-Resistant Chrome Plated Finish
- Notched Drive Locks onto Ratchet or Extension
- Tapered-End 6-Point Sockets

1235

- 8-pc. 3/8" Dr. Deepwell 6-Point Sockets (SAE): 3/8, 7/16, 1/2, 9/16, 5/8, 11/16, 3/4, 13/16"
- 1-pc. Storage Rack

Item	Description	Packaging	Cs	In
1235	3/8" Dr. Deep Socket Set (3/8"-13/16") Cr-V	Plastic Hang Rack/Label	20	10
1240	3/8" Dr. Deep Socket Set (10-19mm) Cr-V	Plastic Hang Rack/Label	20	10

CHROME VANADIUM



1235

1240

- 8-pc. 3/8" Dr. Deepwell 6-Point Sockets (Metric): 10, 11, 12, 13, 14, 15, 17, 19mm
- 1-pc. Storage Rack



1240

1/2" Drive Deep Socket Sets

- Drop Forged Carbon Steel Construction
- Corrosion-Resistant Chrome Plated Finish
- Notched Drive Locks onto Ratchet or Extension
- Tapered-End 6-Point Sockets

1245

- 8-pc. 1/2" Dr. Deepwell 6-Point Sockets (SAE): 1/2, 9/16, 5/8, 11/16, 3/4, 13/16, 7/8, 15/16"
- 1-pc. Storage Rack

Item	Description	Packaging	Cs	In
1245	1/2" Dr. Deep Socket Set (1/2"-15/16") Carbon Steel	Plastic Hang Rack/Label	16	8
1250	1/2" Dr. Deep Socket Set (13-22mm) Carbon Steel	Plastic Hang Rack/Label	16	8

CARBON STEEL



1245

1250

- 8-pc. 1/2" Dr. Deepwell 6-Point Sockets (Metric): 13, 14, 15, 17, 18, 19, 21, 22mm
- 1-pc. Storage Rack



1250

1/2" Drive Deep Socket Sets

- Drop Forged, Heat Treated Chrome Vanadium Steel
- Corrosion-Resistant Chrome Plated Finish
- Notched Drive Locks onto Ratchet or Extension
- Tapered-End 6-Point Sockets

1255

- 8-pc. 1/2" Dr. Deepwell 6-Point Sockets (SAE): 1/2, 9/16, 5/8, 11/16, 3/4, 13/16, 7/8, 15/16"
- 1-pc. Storage Rack

Item	Description	Packaging	Cs	In
1255	1/2" Dr. Deep Socket Set (1/2"-15/16") Cr-V	Plastic Hang Rack/Label	16	8
1260	1/2" Dr. Deep Socket Set (13-22mm) Cr-V	Plastic Hang Rack/Label	16	8

CHROME VANADIUM



1255

1260

- 8-pc. 1/2" Dr. Deepwell 6-Point Sockets (Metric): 13, 14, 15, 17, 18, 19, 21, 22mm
- 1-pc. Storage Rack



1260

10 Individual Sockets

6-Point Socket



12-Point Socket



Universal Joint



Adapters/Reducers



Extensions



1/4" Drive

SAE SIZES

SHALLOW 6-POINT

14100 1/4" DR X 3/16" SHALLOW SKT (6-PT)
 14101 1/4" DR X 7/32" SHALLOW SKT (6-PT)
 14102 1/4" DR X 1/4" SHALLOW SKT (6-PT)
 14103 1/4" DR X 9/32" SHALLOW SKT (6-PT)
 14104 1/4" DR X 5/16" SHALLOW SKT (6-PT)
 14105 1/4" DR X 11/32" SHALLOW SKT (6-PT)
 14106 1/4" DR X 3/8" SHALLOW SKT (6-PT)
 14107 1/4" DR X 7/16" SHALLOW SKT (6-PT)
 14108 1/4" DR X 1/2" SHALLOW SKT (6-PT)

DEEP 6-POINT

14118 1/4" DR X 3/16" DEEP SOCKET (6-PT)
 14119 1/4" DR X 7/32" DEEP SOCKET (6-PT)
 14120 1/4" DR X 1/4" DEEP SOCKET (6-PT)
 14121 1/4" DR X 9/32" DEEP SOCKET (6-PT)
 14122 1/4" DR X 5/16" DEEP SOCKET (6-PT)
 14123 1/4" DR X 11/32" DEEP SOCKET (6-PT)
 14124 1/4" DR X 3/8" DEEP SOCKET (6-PT)
 14125 1/4" DR X 7/16" DEEP SOCKET (6-PT)
 14126 1/4" DR X 1/2" DEEP SOCKET (6-PT)

METRIC SIZES

SHALLOW 6-POINT

14109 1/4" DR X 4MM SHALLOW SKT (6-PT)
 14110 1/4" DR X 5MM SHALLOW SKT (6-PT)
 14111 1/4" DR X 6MM SHALLOW SKT (6-PT)
 14112 1/4" DR X 7MM SHALLOW SKT (6-PT)
 14113 1/4" DR X 8MM SHALLOW SKT (6-PT)
 14114 1/4" DR X 9MM SHALLOW SKT (6-PT)
 14115 1/4" DR X 10MM SHALLOW SKT (6-PT)
 14116 1/4" DR X 11MM SHALLOW SKT (6-PT)
 14117 1/4" DR X 12MM SHALLOW SKT (6-PT)

SOCKET ACCESSORIES

14127 1/4" DR UNIVERSAL JOINT
 14128 1/4" DR X 3" EXTENSION BAR
 14129 1/4" DR X 6" EXTENSION BAR
 14269 1/4" DR (F) X 3/8" DRIVE (M) ADAPTOR

3/8" Drive

SAE SIZES

SHALLOW 6-POINT

14130 3/8" DR X 3/8" SHALLOW SKT (6-PT)
 14131 3/8" DR X 7/16" SHALLOW SKT (6-PT)
 14132 3/8" DR X 1/2" SHALLOW SKT (6-PT)
 14133 3/8" DR X 9/16" SHALLOW SKT (6-PT)
 14134 3/8" DR X 5/8" SHALLOW SKT (6-PT)
 14135 3/8" DR X 11/16" SHALLOW SKT (6-PT)
 14136 3/8" DR X 3/4" SHALLOW SKT (6-PT)
 14137 3/8" DR X 13/16" SHALLOW SKT (6-PT)
 14138 3/8" DR X 7/8" SHALLOW SKT (6-PT)

SHALLOW 12-POINT

14150 3/8" DR X 5/16" SHALLOW SKT (12-PT)
 14154 3/8" DR X 3/8" SHALLOW SKT (12-PT)
 14155 3/8" DR X 7/16" SHALLOW SKT (12-PT)
 14156 3/8" DR X 1/2" SHALLOW SKT (12-PT)
 14157 3/8" DR X 9/16" SHALLOW SKT (12-PT)
 14158 3/8" DR X 5/8" SHALLOW SKT (12-PT)
 14159 3/8" DR X 11/16" SHALLOW SKT (12-PT)
 14160 3/8" DR X 3/4" SHALLOW SKT (12-PT)
 14161 3/8" DR X 13/16" SHALLOW SKT (12-PT)
 14162 3/8" DR X 7/8" SHALLOW SKT (12-PT)

DEEP 6-POINT

14177 3/8" DR X 5/16" DEEP SOCKET (6-PT)
 14178 3/8" DR X 3/8" DEEP SOCKET (6-PT)
 14179 3/8" DR X 7/16" DEEP SOCKET (6-PT)
 14180 3/8" DR X 1/2" DEEP SOCKET (6-PT)
 14181 3/8" DR X 9/16" DEEP SOCKET (6-PT)
 14182 3/8" DR X 5/8" DEEP SOCKET (6-PT)
 14183 3/8" DR X 11/16" DEEP SOCKET (6-PT)
 14184 3/8" DR X 3/4" DEEP SOCKET (6-PT)
 14185 3/8" DR X 13/16" DEEP SOCKET (6-PT)
 14186 3/8" DR X 7/8" DEEP SOCKET (6-PT)
 14187 3/8" DR X 15/16" DEEP SOCKET (6-PT)

METRIC SIZES

SHALLOW 6-POINT

14139 3/8" DR X 7MM SHALLOW SKT (6-PT)
 14140 3/8" DR X 8MM SHALLOW SKT (6-PT)
 14141 3/8" DR X 9MM SHALLOW SKT (6-PT)
 14142 3/8" DR X 10MM SHALLOW SKT (6-PT)
 14143 3/8" DR X 11MM SHALLOW SKT (6-PT)
 14144 3/8" DR X 12MM SHALLOW SKT (6-PT)
 14145 3/8" DR X 13MM SHALLOW SKT (6-PT)
 14146 3/8" DR X 14MM SHALLOW SKT (6-PT)
 14147 3/8" DR X 15MM SHALLOW SKT (6-PT)
 14148 3/8" DR X 16MM SHALLOW SKT (6-PT)
 14149 3/8" DR X 17MM SHALLOW SKT (6-PT)
 14151 3/8" DR X 18MM SHALLOW SKT (6-PT)
 14152 3/8" DR X 19MM SHALLOW SKT (6-PT)
 14153 3/8" DR X 21MM SHALLOW SKT (6-PT)

SHALLOW 12-POINT

14163 3/8" DR X 7MM SHALLOW SKT (12-PT)
 14164 3/8" DR X 8MM SHALLOW SKT (12-PT)
 14165 3/8" DR X 9MM SHALLOW SKT (12-PT)
 14166 3/8" DR X 10MM SHALLOW SKT (12-PT)
 14167 3/8" DR X 11MM SHALLOW SKT (12-PT)
 14168 3/8" DR X 12MM SHALLOW SKT (12-PT)
 14169 3/8" DR X 13MM SHALLOW SKT (12-PT)
 14170 3/8" DR X 14MM SHALLOW SKT (12-PT)
 14171 3/8" DR X 15MM SHALLOW SKT (12-PT)
 14172 3/8" DR X 16MM SHALLOW SKT (12-PT)
 14173 3/8" DR X 17MM SHALLOW SKT (12-PT)
 14174 3/8" DR X 18MM SHALLOW SKT (12-PT)
 14175 3/8" DR X 19MM SHALLOW SKT (12-PT)
 14176 3/8" DR X 21MM SHALLOW SKT (12-PT)

DEEP 6-POINT

14188 3/8" DR X 7MM DEEP SOCKET (6-PT)
 14189 3/8" DR X 8MM DEEP SOCKET (6-PT)
 14190 3/8" DR X 9MM DEEP SOCKET (6-PT)
 14191 3/8" DR X 10MM DEEP SOCKET (6-PT)
 14192 3/8" DR X 11MM DEEP SOCKET (6-PT)
 14193 3/8" DR X 12MM DEEP SOCKET (6-PT)
 14194 3/8" DR X 13MM DEEP SOCKET (6-PT)
 14195 3/8" DR X 14MM DEEP SOCKET (6-PT)
 14196 3/8" DR X 15MM DEEP SOCKET (6-PT)
 14197 3/8" DR X 16MM DEEP SOCKET (6-PT)
 14198 3/8" DR X 17MM DEEP SOCKET (6-PT)
 14199 3/8" DR X 18MM DEEP SOCKET (6-PT)
 14201 3/8" DR X 19MM DEEP SOCKET (6-PT)
 14202 3/8" DR X 21MM DEEP SOCKET (6-PT)

SOCKET ACCESSORIES

14203 3/8" DR X 5/8" SPARK PLUG SOCKET
 14204 3/8" DR X 3/4" SPARK PLUG SOCKET
 14205 3/8" DR X 13/16" SPARK PLUG SOCKET

14206 3/8" DR X 1-3/4" EXTENSION BAR
 14207 3/8" DR X 3" EXTENSION BAR
 14208 3/8" DR X 6" EXTENSION BAR
 14209 3/8" DR X 8" EXTENSION BAR
 14210 3/8" DR UNIVERSAL JOINT
 14270 3/8" DR (F) X 1/2" DRIVE (M) ADAPTER
 14271 3/8" DR (F) X 1/4" DRIVE (M) REDUCER



- Forged and hardened chrome vanadium steel
- Corrosion-resistant chrome plated finish
- 6-point sockets provide maximum torque while 12-point sockets are more versatile

OPTI-DRIVE™ DESIGN:

- Eliminates corner contact to prevent fastener from rounding off

1/2" Drive

	SAE SIZES	SHALLOW 6-POINT	SHALLOW 12-POINT	DEEP 6- & 12-POINT
		14273 1/2" DR X 3/8" SHALLOW SKT (6-PT)	14211 1/2" DR X 3/8" SHALLOW SKT (12-PT)	14236 1/2" DR X 1/2" DEEP SOCKET (12-PT)
		14274 1/2" DR X 7/16" SHALLOW SKT (6-PT)	14212 1/2" DR X 7/16" SHALLOW SKT (12-PT)	14237 1/2" DR X 9/16" DEEP SOCKET (12-PT)
		14275 1/2" DR X 1/2" SHALLOW SKT (6-PT)	14213 1/2" DR X 1/2" SHALLOW SKT (12-PT)	14238 1/2" DR X 5/8" DEEP SOCKET (12-PT)
		14276 1/2" DR X 9/16" SHALLOW SKT (6-PT)	14214 1/2" DR X 9/16" SHALLOW SKT (12-PT)	14239 1/2" DR X 11/16" DEEP SOCKET (12-PT)
		14277 1/2" DR X 5/8" SHALLOW SKT (6-PT)	14215 1/2" DR X 5/8" SHALLOW SKT (12-PT)	14240 1/2" DR X 3/4" DEEP SOCKET (12-PT)
		14278 1/2" DR X 11/16" SHALLOW SKT (6-PT)	14216 1/2" DR X 11/16" SHALLOW SKT (12-PT)	14241 1/2" DR X 13/16" DEEP SOCKET (12-PT)
		14279 1/2" DR X 3/4" SHALLOW SKT (6-PT)	14217 1/2" DR X 3/4" SHALLOW SKT (12-PT)	14242 1/2" DR X 7/8" DEEP SOCKET (12-PT)
		14280 1/2" DR X 13/16" SHALLOW SKT (6-PT)	14218 1/2" DR X 13/16" SHALLOW SKT (12-PT)	14243 1/2" DR X 15/16" DEEP SOCKET (12-PT)
		14281 1/2" DR X 7/8" SHALLOW SKT (6-PT)	14219 1/2" DR X 7/8" SHALLOW SKT (12-PT)	14244 1/2" DR X 1/2" DEEP SOCKET (6-PT)
		14282 1/2" DR X 15/16" SHALLOW SKT (6-PT)	14220 1/2" DR X 15/16" SHALLOW SKT (12-PT)	14245 1/2" DR X 9/16" DEEP SOCKET (6-PT)
		14283 1/2" DR X 1" SHALLOW SKT (6-PT)	14221 1/2" DR X 1" SHALLOW SKT (12-PT)	14246 1/2" DR X 5/8" DEEP SOCKET (6-PT)
		14284 1/2" DR X 1-1/16" SHALLOW SKT (6-PT)	14222 1/2" DR X 1-1/16" SHALLOW SKT (12-PT)	14247 1/2" DR X 11/16" DEEP SOCKET (6-PT)
		14285 1/2" DR X 1-1/8" SHALLOW SKT (6-PT)	14223 1/2" DR X 1-1/8" SHALLOW SKT (12-PT)	14248 1/2" DR X 3/4" DEEP SOCKET (6-PT)
		14286 1/2" DR X 1-1/4" SHALLOW SKT (6-PT)	14224 1/2" DR X 1-1/4" SHALLOW SKT (12-PT)	14249 1/2" DR X 13/16" DEEP SOCKET (6-PT)
				14250 1/2" DR X 7/8" DEEP SOCKET (6-PT)
				14251 1/2" DR X 15/16" DEEP SOCKET (6-PT)
	METRIC SIZES	SHALLOW 6-POINT	SHALLOW 12-POINT	DEEP 6-POINT
		14287 1/2" DR X 12MM SHALLOW SKT (6-PT)	14225 1/2" DR X 12MM SHALLOW SKT (12-PT)	14252 1/2" DR X 12MM DEEP SOCKET (6-PT)
		14288 1/2" DR X 13MM SHALLOW SKT (6-PT)	14226 1/2" DR X 13MM SHALLOW SKT (12-PT)	14253 1/2" DR X 13MM DEEP SOCKET (6-PT)
		14289 1/2" DR X 14MM SHALLOW SKT (6-PT)	14227 1/2" DR X 14MM SHALLOW SKT (12-PT)	14254 1/2" DR X 14MM DEEP SOCKET (6-PT)
		14290 1/2" DR X 15MM SHALLOW SKT (6-PT)	14228 1/2" DR X 15MM SHALLOW SKT (12-PT)	14255 1/2" DR X 15MM DEEP SOCKET (6-PT)
		14291 1/2" DR X 16MM SHALLOW SKT (6-PT)	14229 1/2" DR X 16MM SHALLOW SKT (12-PT)	14256 1/2" DR X 16MM DEEP SOCKET (6-PT)
		14292 1/2" DR X 17MM SHALLOW SKT (6-PT)	14230 1/2" DR X 17MM SHALLOW SKT (12-PT)	14257 1/2" DR X 17MM DEEP SOCKET (6-PT)
		14293 1/2" DR X 18MM SHALLOW SKT (6-PT)	14231 1/2" DR X 18MM SHALLOW SKT (12-PT)	14258 1/2" DR X 18MM DEEP SOCKET (6-PT)
		14294 1/2" DR X 19MM SHALLOW SKT (6-PT)	14232 1/2" DR X 19MM SHALLOW SKT (12-PT)	14259 1/2" DR X 19MM DEEP SOCKET (6-PT)
		14295 1/2" DR X 21MM SHALLOW SKT (6-PT)	14233 1/2" DR X 21MM SHALLOW SKT (12-PT)	14260 1/2" DR X 21MM DEEP SOCKET (6-PT)
		14296 1/2" DR X 22MM SHALLOW SKT (6-PT)	14234 1/2" DR X 22MM SHALLOW SKT (12-PT)	14261 1/2" DR X 22MM DEEP SOCKET (6-PT)
		14297 1/2" DR X 24MM SHALLOW SKT (6-PT)	14235 1/2" DR X 24MM SHALLOW SKT (12-PT)	14262 1/2" DR X 24MM DEEP SOCKET (6-PT)

SOCKET ACCESSORIES	14263 1/2" DR X 5/8" SPARK PLUG SOCKET	14265 1/2" DR X 3" EXTENSION BAR	14268 1/2" DR UNIVERSAL JOINT
	14264 1/2" DR X 13/16" SPARK PLUG SOCKET	14266 1/2" DR X 5" EXTENSION BAR	14272 1/2" DR (F) X 3/8" DRIVE (M) REDUCER
		14267 1/2" DR X 10" EXTENSION BAR	

Spark Plug and Specialty Sockets

- 1785 / 1795
- Drop Forged, Heat Treated Steel Construction
 - Corrosion-Resistant Chrome Plated Finish
 - Built-in Rubber Grommet Grips Spark Plug for Easy Installation and Removal
 - 6-Point Socket End
 - Notched Drive End Locks onto Ratchet or Extension

- 1828
- Fits Heating Element in Many Electric Water Heaters
 - Drop Forged, Heat Treated Chrome Vanadium Steel
 - Corrosion-Resistant Chrome Plated Finish
 - 6-Point Socket End
 - Notched Drive End Locks onto Ratchet or Extension

- 1788
- 5" Length is Ideal for Engines with Overhead Camshafts
 - Drop Forged, Heat Treated Steel Construction
 - Corrosion-Resistant Black Oxide Finish
 - Built-in Rubber Grommet Grips Spark Plug for Easy Installation and Removal
 - 6-Point Socket End
 - Notched Drive End Locks onto Ratchet or Extension

Item	Description	Packaging	Cs	In
1785	3/8" Drive x 5/8" Spark Plug Socket	Slide Blister Card	72	6
1788	3/8" Drive x 5/8" Extra Long Spark Plug Socket	Slide Blister Card	72	12
1795	3/8" Drive x 13/16" Spark Plug Socket	Slide Blister Card	72	6
1828	1/2" Drive x 1-1/2" Water Heater Socket	Slide Blister Card	30	6



12 Bit Sockets

Individual Hex Bit Sockets



- Drop Forged Chrome Vanadium Steel Socket
- Chrome Vanadium Steel Bit with Corrosion-Resistant Black Oxide Finish
- Precision-Machined Tip for Exact Fit
- Notched Socket Locks onto Ratchet or Extension

Item	Description	Packaging	Cs	In
1370	3/8" Drive x 5/32" Hex Bit Socket	Plastic Hang Tab/Label	72	6
1371	3/8" Drive x 3/16" Hex Bit Socket	Plastic Hang Tab/Label	72	6
1372	3/8" Drive x 7/32" Hex Bit Socket	Plastic Hang Tab/Label	72	6
1373	3/8" Drive x 1/4" Hex Bit Socket	Plastic Hang Tab/Label	72	6
1374	3/8" Drive x 5/16" Hex Bit Socket	Plastic Hang Tab/Label	72	6
1375	3/8" Drive x 3/8" Hex Bit Socket	Plastic Hang Tab/Label	72	6
1376	3/8" Drive x 6mm Hex Bit Socket	Plastic Hang Tab/Label	72	6
1377	3/8" Drive x 8mm Hex Bit Socket	Plastic Hang Tab/Label	72	6
1378	3/8" Drive x 10mm Hex Bit Socket	Plastic Hang Tab/Label	72	6



9-pc. 3/8" Drive Star Bit Socket Set (SD10-50)

- Drop Forged, Heat Treated Carbon Steel Sockets
- Precision-Machined Chrome Vanadium Steel Bits
- Durable Chrome Plated Finish on Sockets and Sandblasted Finish on Bits Resist Corrosion
- 9-pc. 3/8" Drive Star Bit Sockets: SD-10, SD-15, SD-20, SD-25, SD-27, SD-30, SD-40, SD-45, SD-50
- 1-pc. 9-Clip Socket Holder

Item	Description	Packaging	Cs	In
1351	9-pc. 3/8" Drive Star Bit Socket Set (SD10-50)	Slide Blister Card	36	6



7-pc. 3/8" Drive Ball Hex Bit Socket Set (SAE)

- Drop Forged Chrome Vanadium Steel Sockets
- Precision-Machined Chrome Vanadium Steel Bits
- Corrosion-Resistant Chrome-Plated (Sockets) and Brass-Coated Finishes (Bits)
- Notches in Sockets Lock onto Ratchets and Extensions
- Ball End Allows up to 25° Entry Angle for Extra Clearance in Tight Spots
- 7-pc. Ball Hex Bits (SAE): 1/8", 5/32", 3/16", 7/32", 1/4", 5/16", 3/8"
- Complete with 7-Clip Socket Holder

Item	Description	Packaging	Cs	In
1358	7-pc. 3/8" Drive Ball Hex Bit Socket Set (SAE)	Slide Blister Card	36	6

3/8" Drive Hex Bit Socket Sets

- Drop Forged, Heat Treated Carbon Steel Sockets
- Precision-Machined Chrome Vanadium Steel Bits
- Durable Chrome Plated Finish on Sockets and Sandblasted Finish on Bits Resist Corrosion

1361

- 7-pc. Hex Bit Sockets (SAE): 1/8", 5/32", 3/16", 7/32", 1/4", 5/16", 3/8"
- 2-pc. Screwdriver Bit Sockets: 1/4" Flat, #2 Phillips
- 1-pc. 9-Clip Socket Holder

1366

- 7-pc. Hex Bit Sockets (Metric): 3, 4, 5, 5.5, 6, 8, 10mm
- 2-pc. Screwdriver Bit Sockets: 1/4" Flat, #2 Phillips
- 1-pc. 9-Clip Socket Holder

Item	Description	Packaging	Cs	In
1361	9-pc. 3/8" Drive Hex Bit Socket Set (1/8"-3/8")	Slide Blister Card	36	6
1366	9-pc. 3/8" Drive Hex Bit Socket Set (3-10mm)	Slide Blister Card	36	6



3/8" Drive Hex Bit Socket Sets

- Drop Forged, Heat Treated Carbon Steel Sockets
- Precision-Machined Chrome Vanadium Steel Bits
- Durable Chrome Plated Finish on Sockets and Sandblasted Finish on Bits Resist Corrosion

1360

- 7-pc. Hex Bit Sockets (SAE): 1/8", 5/32", 3/16", 7/32", 1/4", 5/16", 3/8"
- 2-pc. Screwdriver Bit Sockets: 1/4" Flat, #2 Phillips
- 1-pc. Storage Case

1365

- 7-pc. Hex Bit Sockets (Metric): 3, 4, 5, 5.5, 6, 8, 10mm
- 2-pc. Screwdriver Bit Sockets: 1/4" Flat, #2 Phillips
- 1-pc. Storage Case

Item	Description	Packaging	Cs	In
1360	9-pc. 3/8" Drive Hex Bit Socket Set (1/8"-3/8")	Color Box	50	1
1365	9-pc. 3/8" Drive Hex Bit Socket Set (3-10mm)	Color Box	50	1



7-pc. 3/8" Drive Extra Long Star Bit Socket Set

- Hardened S-2 Steel Bits with Corrosion-Resistant Black Oxide Finish
- Forged Chrome Vanadium Steel Sockets
- Notched Drive Locks onto Drive Tang
- Use with 3/8" Drive Ratchets
- Two-Piece Design Allows Replacement of Worn or Damaged Bits
- 6" Length
- 7-pc. 3/8" Drive Star Bit Sockets: SD-10, 15, 20, 25, 27, 30, 40
- Complete with Storage Case

Item	Description	Packaging	Cs	In
1352	7-pc. 3/8" Drive Extra Long Star Bit Socket Set	Color Box	24	1



7-pc. 3/8" Drive Extra Long Hex Bit Socket Sets

- Hardened S-2 Steel Bits with Corrosion-Resistant Black Oxide Finish
- Forged Chrome Vanadium Steel Sockets
- Notched Drive Locks onto Drive Tang
- Use with 3/8" Drive Ratchets
- Two-Piece Design Allows Replacement of Worn or Damaged Bits
- 6" Length

1362

- 7-pc. 3/8" Drive Hex Bit Sockets (SAE): 1/8", 5/32", 3/16", 7/32", 1/4", 5/16", 3/8"
- Complete with Storage Case

1363

- 7-pc. 3/8" Drive Hex Bit Sockets (Metric): 3, 4, 5, 6, 7, 8, 10mm
- Complete with Storage Case

Item	Description	Packaging	Cs	In
1362	7-pc. 3/8" Drive Extra Long Hex Bit Socket Set (SAE)	Color Box	24	1
1363	7-pc. 3/8" Drive Extra Long Hex Bit Socket Set (Metric)	Color Box	24	1



14 Ratchets and Breaker Bars



Ratchet Handles

- Drop Forged Chrome Vanadium Steel
- Heat Treated and Chrome Plated
- Spring Loaded Ball Bearings Hold Sockets Securely
- Quick-Action Reverse Lever Metal Speed Spin Disc
- Rubber Grips on Handles Provide a Comfortable Grip and Added Torque
- Meets or Exceeds ANSI Standards

Item	Description	Packaging	Cs	In
1445	1/4" Drive x 6" Ratchet Handle	Plastic Hang Tab/Label	72	6
1450	3/8" Drive x 8" Ratchet Handle	Plastic Hang Tab/Label	48	6
1455	1/2" Drive x 10" Ratchet Handle	Plastic Hang Tab/Label	36	6

Mechanic's Ratchet Handles

- Drop Forged, Heat Treated Chrome Vanadium Steel
- Chrome Plated Finish Resists Corrosion
- Spring-Loaded Ball Bearing Locks onto Sockets
- Built-in Speed Disc
- Meets or Exceeds ANSI Standards

Item	Description	Packaging	Cs	In
1440	1/4" Drive x 6" Mechanic's Ratchet Handle	Plastic Hang Tab/Label	72	6
1441	3/8" Drive x 8" Mechanic's Ratchet Handle	Plastic Hang Tab/Label	48	6
1442	1/2" Drive x 10" Mechanic's Ratchet Handle	Plastic Hang Tab/Label	36	6

Mechanic's Flex Ratchet Handles

- 180°, 5-Position Flex Head
- Drop Forged, Heat Treated Chrome Vanadium Steel
- Corrosion-Resistant Chrome Plated Finish
- Spring-Loaded Ball Bearing Locks onto Sockets
- Built-in Speed Disc
- Meets or Exceeds ANSI Standards

Item	Description	Packaging	Cs	In
1460	3/8" Drive x 11" Mechanic's Flex Ratchet Handle	Plastic Hang Tab/Label	36	6
1462	3/8" Drive x 11" Mechanic's Flex Offset Ratchet Handle	Plastic Hang Tab/Label	36	6
1470	3/8" Drive x 6" Mechanic's Flex Stubby Ratchet Handle	Plastic Hang Tab/Label	60	6

Jumbo Ratchet Handles

- Drop Forged Steel Construction
- Heat Treated and Chrome Plated
- Spring Loaded Ball Bearings Lock Sockets Securely onto Ratchet Handle
- Durable Cast Steel Reverse Levers
- Knurled Handle for Sure Grip
- Long Lever Arms Provide Superior Leverage

Item	Description	Packaging	Cs	In
1540	3/4" Drive x 18" Ratchet Handle	Color Label	10	1
1545	1" Drive x 26" Ratchet Handle	Color Label	5	1





Quick-Release Ratchet Handles

- Drop Forged, Heat Treated Chrome Vanadium Steel
- Corrosion-Resistant Chrome Plated Finish
- Comfortable, Non-Slip Soft Grip
- Quick-Release, Lock-On Drive Tang Prevents Dropped or Stuck Sockets
- Meets or Exceeds ANSI Standards

Item	Description	Packaging	Cs	In
1476	1/4" Drive x 6" Quick-Release Ratchet Handle	Plastic Hang Tab/Label	72	6
1477	3/8" Drive x 8" Quick-Release Ratchet Handle	Plastic Hang Tab/Label	48	6
1478	1/2" Drive x 10" Quick-Release Ratchet Handle	Plastic Hang Tab/Label	24	6



1438



1466

Finger/Palm Ratchets

1438

- Forged, Heat Treated Carbon Steel Construction
- Corrosion-Resistant Chrome Plated Finish
- Forward and Reverse Drive
- Non-Slip, Knurled Finger Grip
- Designed for Extra Speed, Especially in Tight Spaces

1466

- Solid, Cast, Contoured Finger Grip Body
- Corrosion-Resistant Chrome Plated Finish
- Hardened Chrome Vanadium Steel Ratchet Construction
- Compact Size for Tight Work Areas

Item	Description	Packaging	Cs	In
1438	3/8" Drive Speed Ratchet	Slide Blister Card	96	6
1466	3/8" Drive Mechanic's Palm Ratchet	Slide Blister Card	60	6



7-pc. Hollow Shaft Nut Driver Set (SAE)

- Hollow Shafts Fit Over Long Bolts
- Forged and Heat Treated Carbon Steel
- Corrosion-Resistant Chrome Plated Finish
- Comfortable 6-Flute Acetate Handles
- ANSI Standard Color-Coded Handles for Quick Size Selection
- 7-pc. Nut Drivers (SAE): 3/16, 1/4, 5/16, 11/32, 3/8, 7/16, 1/2"

Item	Description	Packaging	Cs	In
1398	7-pc. Hollow Shaft Nut Driver Set (SAE)	Sealed Blister	40	5



7-pc. Hollow Shaft Nut Driver Set (SAE)

- 1" Hollow Shafts Fit Over Long Bolts
- Rugged Heat Treated Carbon Steel Shafts
- Corrosion-Resistant Chrome Plated Finish
- Full-Size, Comfortable 4-Flute Poly Handles
- ANSI Standard Color-Coded Handles for Quick Size Selection

- Overall Length: 6-1/4"
- Shaft Length: 2-3/4"

- 7-pc. Nut Drivers (SAE): 3/16, 1/4, 5/16, 11/32, 3/8, 7/16, 1/2"

Item	Description	Packaging	Cs	In
1401	7-pc. Hollow Shaft Nut Driver Set (SAE)	Sealed Blister	24	6



3/8" Drive x 12" Mechanic's Flex Breaker Bar

- Forged and Hardened Chrome Vanadium Steel
- Corrosion-Resistant Chrome Plated Finish
- 180° Flex Head
- Spring-Loaded Ball Bearing Locks onto Sockets
- Meets or Exceeds ANSI Standards

Item	Description	Packaging	Cs	In
1695	3/8" Drive x 12" Mechanic's Flex Breaker Bar	Plastic Hang Tab/Label	50	5



1/2" Drive x 15" Flex Breaker Bar

- Forged, Heat Treated Carbon Steel
- Corrosion-Resistant Chrome Plated Finish
- 180° Flex Head
- Non-Slip Textured Rubber Handle Grip
- Spring-Loaded Ball Bearing Locks onto Sockets
- Meets or Exceeds ANSI Standards

Item	Description	Packaging	Cs	In
1701	1/2" Drive x 15" Flex Breaker Bar	Plastic Hang Tab/Label	24	6



1/2" Drive x 16" Mechanic's Flex Breaker Bar

- Forged and Hardened Chrome Vanadium Steel
- Corrosion-Resistant Chrome Plated Finish
- 180° Flex Head
- Non-Slip Knurled Handle Grip
- Spring-Loaded Ball Bearing Locks onto Sockets
- Meets or Exceeds ANSI Standards

Item	Description	Packaging	Cs	In
1702	1/2" Drive x 16" Mechanic's Flex Breaker Bar	Plastic Hang Tab/Label	30	5



1/2" Drive x 25" Mechanic's Flex Breaker Bar

- Forged and Hardened Chrome Vanadium Steel
- Corrosion-Resistant Chrome Plated Finish
- 180° Flex Chrome Molybdenum Head
- Spring-Loaded Ball Bearing Locks onto Sockets
- Meets or Exceeds ANSI Standards

Item	Description	Packaging	Cs	In
1703	1/2" Drive x 25" Mechanic's Flex Breaker Bar	Color Label	20	5



3/4" Drive x 24" Flex Breaker Bar

- Forged and Hardened Carbon Steel Construction
- Corrosion-Resistant Chrome Plated Finish
- 180° Flex Head
- Non-Slip Knurled Handle Grip
- Spring-Loaded Ball Bearing Locks onto Sockets

Item	Description	Packaging	Cs	In
1705	3/4" Drive x 24" Flex Breaker Bar	Color Label	12	1



3/4" Drive x 40" Flex Breaker Bar

- Forged and Hardened Chrome Vanadium Steel Handle
- Corrosion-Resistant Chrome Plated Finish
- Chrome Molybdenum Steel Head with Black Phosphate Finish
- Meets or Exceeds ANSI Torque Standards

Item	Description	Packaging	Cs	In
1706	3/4" Drive x 40" Flex Breaker Bar	Color Label	6	1



3-pc. Extension Bar Sets

- Drop Forged Carbon Steel
- Durable Chrome Plated Finish Resists Corrosion
- Spring Loaded Ball Bearing Locks onto Sockets

- 1595 • 3-pc. 1/4" Dr. Extensions: 3", 6", 9"
- 1600 • 3-pc. 3/8" Dr. Extensions: 3", 6", 8"
- 1605 • 3-pc. 1/2" Dr. Extensions: 3", 6", 8"

Item	Description	Packaging	Cs	In
1595	3-pc. 1/4" Drive Extension Bar Set	Plastic Hang Tab/Label	40	10
1600	3-pc. 3/8" Drive Extension Bar Set	Plastic Hang Tab/Label	30	10
1605	3-pc. 1/2" Drive Extension Bar Set	Plastic Hang Tab/Label	30	10



3-pc. Extra Long Extension Bar Sets

- Drop Forged Carbon Steel
- Durable Chrome Plated Finish Resists Corrosion
- Spring-Loaded Ball Bearing Locks onto Sockets
- Notches on Extension Lock onto Ratchet Drive

- 1610 • 3-pc. 3/8" Dr. Extensions: 15", 18", 24"
- 1615 • 3-pc. 1/2" Dr. Extensions: 15", 18", 24"

Item	Description	Packaging	Cs	In
1610	3-pc. 3/8" Drive Extra Long Extension Bar Set	Plastic Hang Tab/Label	12	6
1615	3-pc. 1/2" Drive Extra Long Extension Bar Set	Plastic Hang Tab/Label	10	5

3-pc. 3/4" Drive Extension Bar Set

- Drop Forged, Heat Treated Carbon Steel
- Durable Chrome Plated Finish Resists Corrosion
- Spring-Loaded Ball Bearing Locks onto Sockets
- Notches on Extension Lock onto Ratchet Drive

- 3-pc. 3/4" Dr. Extensions: 8", 10", 12"
- Complete with Divided Storage Pouch

Item	Description	Packaging	Cs	In
1630	3-pc. 3/4" Drive Extension Bar Set	Pouch/UPC	10	1



Wobble Extension Bars

- Drop Forged, Heat Treated Chrome Vanadium Steel
- Corrosion-Resistant Chrome Plated Finish
- Knurled-Pattern Grip Area for Sure, Non-Slip Handling
- Spring-Loaded Ball Bearing Retains Socket
- Unique, Combination Design Fits into Socket in Two Positions: Fully Inserted for Standard Extension or Partially Inserted for Wobble Extension, Providing Offset Clearance for Hard-to-Reach Fasteners

- 1660
- 3-pc. 1/4" Dr. Extensions: 2", 4", 9"
- 3-pc. 3/8" Dr. Extensions: 3", 6", 9"
- 3-pc. 1/2" Dr. Extensions: 1-3/4", 5", 10"

Item	Description	Packaging	Cs	In
1653	3/8" Drive x 3" Wobble Extension Bar	Plastic Hang Tab/Label	144	6
1654	3/8" Drive x 6" Wobble Extension Bar	Plastic Hang Tab/Label	144	6
1657	1/2" Drive x 5" Wobble Extension Bar	Plastic Hang Tab/Label	72	6
1658	1/2" Drive x 10" Wobble Extension Bar	Plastic Hang Tab/Label	48	6
1660	9-pc. Combination Wobble Extension Bar Set	Color Box	16	1

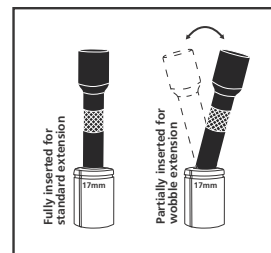



Universal Joints

- Drop Forged Carbon Steel
- Durable Chrome Plated Finish Resists Corrosion
- Spring-Loaded Ball Bearing Locks onto Sockets

1730

- 3-pc. Universal Joints: 1/4" Dr. (F) x 1/4" Dr. (M), 3/8" Dr. (F) x 3/8" Dr. (M), 1/2" Dr. (F) x 1/2" Dr. (M)

Item	Description	Packaging	Cs	In
1730	3-pc. Universal Joint Set	Slide Blister Card	120	10
1735	1/4" Drive Universal Joint	Slide Blister Card	360	12
1740	3/8" Drive Universal Joint	Slide Blister Card	216	12
1745	1/2" Drive Universal Joint	Slide Blister Card	144	12



3-pc. Ratchet Adapter Set

- Drop Forged Carbon Steel
- Durable Chrome Plated Finish Resists Corrosion
- Spring-Loaded Ball Bearing Locks onto Sockets

- 1-pc. 1/4" Dr. (F) x 3/8" Dr. (M) Adapter
- 1-pc. 3/8" Dr. (F) x 1/2" Dr. (M) Adapter
- 1-pc. 1/2" Dr. (F) x 3/4" Dr. (M) Adapter

Item	Description	Packaging	Cs	In
1770	3-pc. Ratchet Adapter Set	Slide Blister Card	96	12



3-pc. Ratchet Reducer Set

- Drop Forged Carbon Steel
- Durable Chrome Plated Finish Resists Corrosion
- Spring-Loaded Ball Bearing Locks onto Sockets

- 1-pc. 3/8" Dr. (F) x 1/4" Dr. (M) Reducer
- 1-pc. 1/2" Dr. (F) x 3/8" Dr. (M) Reducer
- 1-pc. 3/4" Dr. (F) x 1/2" Dr. (M) Reducer

Item	Description	Packaging	Cs	In
1775	3-pc. Ratchet Reducer Set	Slide Blister Card	96	12

Socket Holders

- Nickel Plated Steel Construction with Spring-Steel Socket Clips
- Holds 16 Sockets Each
- Carry in Tool Box or Mount to Wall or Workbench

1885

- 3-pc. 16-Clip Socket Holders: 1/4" Drive, 3/8" Drive, 1/2" Drive

Item	Description	Packaging	Cs	In
1885	3-pc. 1/4", 3/8", 1/2" Drive Socket Holder Set	Blister Card	50	5
1890	1/4" Drive Socket Holder	Blister Card	100	10
1895	3/8" Drive Socket Holder	Blister Card	100	10
1900	1/2" Drive Socket Holder	Blister Card	100	10



Round Magnetic Parts Tray

- Heavy-Gauge Polished Stainless Steel
- Soft Covering Over Magnet Prevents Damage to Finished Surfaces
- Mounts to Hood, Fenders, or Other Ferrous Metal Surfaces Around Work Area
- Keeps Nuts and Bolts, Parts, and Small Tools within Reach
- Prevents Lost or Misplaced Parts and Fasteners
- Capacity: 2 Lb.
- Dimensions: 5-1/2" Diameter, 1-1/8" Deep

Item	Description	Packaging	Cs	In
1902	Round Magnetic Parts Tray	Sealed Blister	36	6



Rectangle Magnetic Parts Tray

- Heavy-Gauge Polished Stainless Steel
- Soft Covering Over Magnets Prevents Damage to Finished Surfaces
- Mounts to Hood, Fenders, or Other Ferrous Metal Surfaces Around Work Area
- Keeps Nuts and Bolts, Parts, and Small Tools within Reach
- Prevents Lost or Misplaced Parts and Fasteners
- Capacity: 4 Lb.
- Dimensions: 9-1/16" L x 5-5/16" W x 1-5/16" D

Item	Description	Packaging	Cs	In
1903	Rectangle Magnetic Parts Tray	Sealed Blister	24	4

20 Wrenches



1910



1911



1912



1913

9-pc. Combination Wrench Sets

- Drop Forged Chrome Vanadium Steel
- Heat Treated and Chrome Plated
- 15° Angled Open Ends
- Precision-Machined 12-Point Box Ends
- Meets or Exceeds ANSI Standards

1910

- 9-pc. Combination Wrenches (SAE): 1/4", 5/16", 3/8", 7/16", 1/2", 9/16", 5/8", 11/16", 3/4"
- Complete with Storage Rack

1911

- 9-pc. Combination Wrenches (Metric): 6, 8, 10, 12, 13, 15, 17, 18, 19mm
- Complete with Storage Rack

Item	Description	Packaging	Cs	In
1910	9-pc. Combination Wrench Set (SAE)	Plastic Hang Rack/Label	18	3
1911	9-pc. Combination Wrench Set (Metric)	Plastic Hang Rack/Label	18	3

11-pc. Combination Wrench Sets

- Drop Forged Chrome Vanadium Steel
- Heat Treated and Chrome Plated
- 15° Angled Open Ends
- Precision-Machined 12-Point Box Ends
- Meets or Exceeds ANSI Standards

1912

- 11-pc. Combination Wrenches (SAE): 1/4", 5/16", 3/8", 7/16", 1/2", 9/16", 5/8", 11/16", 3/4", 13/16", 7/8"
- Complete with Storage Rack

1913

- 11-pc. Combination Wrenches (Metric): 8, 10, 11, 12, 13, 14, 15, 16, 17, 18, 19mm
- Complete with Storage Rack

Item	Description	Packaging	Cs	In
1912	11-pc. Combination Wrench Set (SAE)	Plastic Hang Rack/Label	12	3
1913	11-pc. Combination Wrench Set (Metric)	Plastic Hang Rack/Label	12	3



1917



1924

SAE/Metric Combination Wrench Sets

- Drop Forged Chrome Vanadium Steel
- Heat Treated and Chrome Plated
- 15° Angled Open Ends
- Precision-Machined 12-Point Box Ends
- Meets or Exceeds ANSI Standards

1917

- 6-pc. Stubby (SAE): 3/8", 7/16", 1/2", 9/16", 5/8", 11/16"
- 6-pc. Stubby (Metric): 10, 11, 12, 14, 16, 19mm
- 9-pc. Long (SAE): 1/4", 5/16", 3/8", 7/16", 1/2", 9/16", 5/8", 3/4", 7/8"
- 9-pc. Long (Metric): 7, 8, 9, 10, 12, 13, 15, 17, 18mm
- Complete with Storage Rack

1924

- 7-pc. (SAE): 5/16", 3/8", 7/16", 1/2", 9/16", 5/8", 3/4"
- 7-pc. (Metric): 8, 10, 12, 13, 15, 17, 19mm
- Complete with Storage Rack

Item	Description	Packaging	Cs	In
1917	30-pc. Combination Wrench Set (SAE/Metric)	Plastic Hang Rack/Label	4	2
1924	14-pc. Combination Wrench Set (SAE/Metric)	Plastic Hang Rack/Label	16	4



1920



1921

Stubby Combination Wrench Sets

- Drop Forged Chrome Vanadium Steel
- Heat Treated and Chrome Plated
- 15° Angled Open Ends
- Precision-Machined 12-Point Box Ends
- Meets or Exceeds ANSI Standards

1920

- 8-pc. Combination Wrenches (SAE): 7/16", 1/2", 9/16", 5/8", 11/16", 3/4", 15/16", 1"
- Complete with Storage Rack

1921

- 10-pc. Combination Wrenches (Metric): 10, 11, 12, 13, 14, 15, 16, 17, 18, 19mm
- Complete with Storage Rack

Item	Description	Packaging	Cs	In
1920	8-pc. Stubby Combination Wrench Set (SAE)	Plastic Hang Rack/Label	12	3
1921	10-pc. Stubby Combination Wrench Set (Metric)	Plastic Hang Rack/Label	12	3



1918



1919

Stubby Combination Wrench Sets

- Drop Forged, Heat Treated Carbon Steel
- Corrosion-Resistant Chrome Plated Finish
- 15° Angled Open Ends
- Precision-Machined 12-Point Box Ends
- Compact Size for Tight Work Areas
- Meets or Exceeds ANSI Standards

1918

- 8-pc. Stubby Wrenches (SAE): 7/16, 1/2, 9/16, 5/8, 11/16, 3/4, 15/16, 1"
- Complete with Storage Case

1919

- 10-pc. Stubby Wrenches (Metric): 10, 11, 12, 13, 14, 15, 16, 17, 18, 19mm
- Complete with Storage Case

Item	Description	Packaging	Cs	In
1918	8-pc. Stubby Combination Wrench Set (SAE)	Color Label	24	6
1919	10-pc. Stubby Combination Wrench Set (Metric)	Color Label	24	6



24-pc. Combination Wrench Set (SAE/Metric)

- Drop Forged, Heat Treated Chrome Vanadium Steel
- Corrosion-Resistant Chrome Plated Finish
- Raised Panel for Added Strength
- Precision Machined 15° Angled Open Ends and 12-Point Offset Box Ends
- Meets or Exceeds ANSI Standards

- 12-pc. (SAE): 1/4", 5/16", 3/8", 7/16", 1/2", 9/16", 5/8", 11/16", 3/4", 13/16", 7/8", 1"
- 12-pc. (Metric): 8, 10, 11, 12, 13, 14, 15, 17, 18, 19, 21, 24mm
- Complete with Roll-Up Storage Pouch

Item	Description	Packaging	Cs	In
1916	24-pc. Combination Wrench Set (SAE/Metric)	Color Box	6	1



1925



1930

11-pc. Combination Wrench Sets

- Drop Forged, Heat Treated Chrome Vanadium Steel
- Corrosion-Resistant Chrome Plated Finish
- Precision-Machined 15° Angled Open Ends and 12-Point Offset Box Ends
- Meets or Exceeds ANSI Standards

1925

- 11-pc. Combination Wrenches (SAE): 3/8, 7/16, 1/2, 9/16, 5/8, 11/16, 3/4, 13/16, 7/8, 15/16, 1"
- Complete with Roll-Up Storage Pouch

1930

- 11-pc. Combination Wrenches (Metric): 6, 8, 9, 10, 11, 12, 13, 15, 17, 18, 19mm
- Complete with Roll-Up Storage Pouch

Item	Description	Packaging	Cs	In
1925	11-pc. Combination Wrench Set (SAE)	Color Box	12	1
1930	11-pc. Combination Wrench Set (Metric)	Color Box	12	1



15-pc. Combination Wrench Set (Metric)

- Drop Forged, Heat Treated Chrome Vanadium Steel
- Corrosion-Resistant Chrome Plated Finish
- Precision-Machined 15° Angled Open Ends and 12-Point Offset Box Ends
- Meets or Exceeds ANSI Standards

- 15-pc. Combination Wrenches (Metric): 10, 11, 12, 13, 14, 15, 16, 17, 18, 19, 20, 21, 22, 23, 24mm
- Complete with Roll-Up Storage Pouch

Item	Description	Packaging	Cs	In
1947	15-pc. Combination Wrench Set (Metric)	Color Box	10	1



14-pc. Combination Wrench Set (SAE)

- Drop Forged, Heat Treated Chrome Vanadium Steel
- Corrosion-Resistant Chrome Plated Finish
- Precision-Machined 15° Angled Open Ends and 12-Point Offset Box Ends
- Meets or Exceeds ANSI Standards

- 14-pc. Combination Wrenches (SAE): 3/8", 7/16", 1/2", 9/16", 5/8", 11/16", 3/4", 13/16", 7/8", 15/16", 1", 1-1/16", 1-1/8", 1-1/4"
- Complete with Roll-Up Storage Pouch

Item	Description	Packaging	Cs	In
1942	14-pc. Combination Wrench Set (SAE)	Color Box	6	1



1959

1958

Jumbo Angle Open End Wrench Sets

- Drop Forged, Heat Treated Carbon Steel
- Corrosion-Resistant Chrome Plated Finish
- Raised Panel for Added Strength
- Precision Machined 15° and 45° Angled Open Ends
- Meets or Exceeds ANSI Standards

- 1958
- 4-pc. Open End Wrenches (SAE): 1-5/16, 1-3/8, 1-7/16, 1-1/2"
- Complete with Roll-Up Storage Pouch

- 1959
- 6-pc. Open End Wrenches (SAE): 1-3/8, 1-1/2, 1-5/8, 1-3/4, 1-7/8, 2"

Item	Description	Packaging	Cs	In
1958	4-pc. Jumbo Angle Open End Wrench Set (SAE)	Pouch/Color Label	6	3
1959	6-pc. Jumbo Angle Open End Wrench Set (SAE)	Plain Box/UPC	2	1



1937

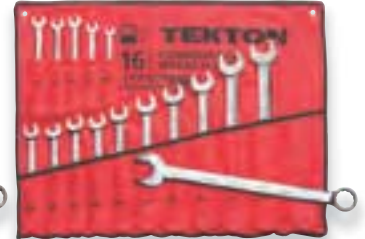

1938



Combination Wrench Sets

- 15° Angled MaxTorq™ V-Cut Open End Design Grips Fastener Head on Four Sides, Applying More Torque than Standard Wrenches
- Long Pattern, Thin Panel Wrenches for Extra Leverage and Long Reach
- Drop Forged, Heat Treated High Carbon Steel
- Polished, Corrosion-Resistant, Triple-Chrome-Plated Finish
- Precision-Machined 12-Point Offset Box Ends
- Meets or Exceeds ANSI Standards

1937

- 14-pc. Combination Wrenches (SAE): 3/8, 7/16, 1/2, 9/16, 5/8, 11/16, 3/4, 13/16, 7/8, 15/16, 1, 1-1/16, 1-1/8, 1-1/4"
- Complete with Roll-Up Storage Pouch

1938

- 16-pc. Combination Wrenches (Metric): 10, 11, 12, 13, 14, 15, 16, 17, 18, 19, 21, 23, 24, 27, 30, 32mm
- Complete with Roll-Up Storage Pouch

Item	Description	Packaging	Cs	In
1937	14-pc. MaxTorq™ Combination Wrench Set (SAE)	Color Box	4	1
1938	16-pc. MaxTorq™ Combination Wrench Set (Metric)	Color Box	4	1



2008



2009

Angle Open End Wrench Sets

- Drop Forged, Heat Treated Carbon Steel
- Polished, Corrosion-Resistant Chrome Plated Finish
- Precision-Machined 15° and 45° Angled Open Ends
- Meets or Exceeds ANSI Standards

2008

- 14-pc. Angle Open End Wrenches (SAE): 3/8, 7/16, 1/2, 9/16, 5/8, 11/16, 3/4, 13/16, 7/8, 15/16, 1, 1-1/16, 1-1/8, 1-1/4"
- Complete with Roll-Up Storage Pouch

2009

- 15-pc. Angle Open End Wrenches (Metric): 10, 11, 12, 13, 14, 15, 16, 17, 18, 19, 20, 21, 22, 23, 24mm
- Complete with Roll-Up Storage Pouch

Item	Description	Packaging	Cs	In
2008	14-pc. Angle Open End Wrench Set (SAE)	Pouch/Color Label	6	3
2009	15-pc. Angle Open End Wrench Set (Metric)	Pouch/Color Label	6	3



6-pc. Jumbo Combination Wrench Sets

- Drop Forged, Heat Treated Carbon Steel
- Corrosion-Resistant Chrome Plated Finish
- Raised Panel for Added Strength
- Precision Machined 15° Angled Open Ends and 12-Point Offset Box Ends
- Meets or Exceeds ANSI Standards

1960

- 6-pc. Jumbo Combination Wrenches (SAE): 1-3/8", 1-1/2", 1-5/8", 1-3/4", 1-7/8", 2"

1961

- 6-pc. Jumbo Combination Wrenches (Metric): 27, 30, 32, 33, 34, 35mm

Item	Description	Packaging	Cs	In
1960	6-pc. Jumbo Combination Wrench Set (SAE)	Color Box	2	1
1961	6-pc. Jumbo Combination Wrench Set (Metric)	Plain Box/UPC	2	1



4-pc. Jumbo Combination Wrench Set

- Drop Forged, Heat Treated Carbon Steel
- Corrosion-Resistant Chrome Plated Finish
- Raised Panel for Added Strength
- Precision Machined 15° Angled Open Ends and 12-Point Offset Box Ends
- Meets or Exceeds ANSI Standards

- 4-pc. Jumbo Combination Wrenches (SAE): 1-5/16, 1-3/8, 1-7/16, 1-1/2"
- Complete with Roll-Up Storage Pouch

Item	Description	Packaging	Cs	In
1955	4-pc. Jumbo Combination Wrench Set	Pouch/Color Label	6	1



10-pc. Jumbo Combination Wrench Sets

- Drop Forged, Heat Treated Carbon Steel
- Corrosion-Resistant Chrome Plated Finish
- Raised Panel for Added Strength
- Precision Machined 15° Angled Open Ends and 12-Point Offset Box Ends
- Meets or Exceeds ANSI Standards

1962

- 10-pc. Jumbo Combination Wrenches (SAE): 1-5/16, 1-3/8, 1-7/16, 1-1/2, 1-5/8, 1-11/16, 1-3/4, 1-13/16, 1-7/8, 2"

1963

- 10-pc. Jumbo Combination Wrenches (Metric): 34, 36, 38, 41, 42, 44, 45, 46, 48, 50mm

Item	Description	Packaging	Cs	In
1962	10-pc. Jumbo Combination Wrench Set (SAE)	Plain Box/UPC	2	1
1963	10-pc. Jumbo Combination Wrench Set (Metric)	Plain Box/UPC	2	1



10-pc. Jumbo Combination Wrench Set (SAE)

- Industrial Grade Drop Forged Carbon Steel Construction
- Corrosion-Resistant Chrome Plated Finish
- 15° Angled Open Ends
- Precision-Machined Offset 12-Point Box Ends
- Meets or Exceeds ANSI Standards
- 10-pc. Jumbo Combination Wrenches: 1-5/16", 1-3/8", 1-7/16", 1-1/2", 1-5/8", 1-11/16", 1-3/4", 1-13/16", 1-7/8", 2"
- Complete with Heavy Duty Roll-Up Storage Pouch with Carry Handle

Item	Description	Packaging	Cs	In
19621	10-pc. Jumbo Combination Wrench Set (SAE)	White Box/Color Label	2	1

24 Wrenches



1965



1992
1993



2205
2210



2216
2217

5-pc. Combination Wrench Sets

- Drop Forged, Heat Treated Carbon Steel
- Polished Chrome Plated Finish Resists Corrosion
- Precision Machined 15° Angled Open Ends and 12-Point Offset Box Ends
- Meets or Exceeds ANSI Standards

- 1965 • 5-pc. Combination Wrenches (SAE): 3/8, 7/16, 1/2, 9/16, 5/8"
 1992 • 5-pc. Combination Wrenches (SAE): 3/8", 7/16", 1/2", 9/16", 5/8"
 1993 • 5-pc. Combination Wrenches (Metric): 8, 10, 12, 13, 17mm

Item	Description	Packaging	Cs	In
1965	5-pc. Combination Wrench Set (SAE)	Slide Blister Card	36	6
1992	5-pc. Combination Wrench Set (SAE)	Slide Blister Card	36	6
1993	5-pc. Combination Wrench Set (Metric)	Slide Blister Card	36	6

Ratchet Box End Wrench Sets

- Rugged Carbon Steel and Nylon Housing
- Corrosion-Resistant Chrome Plated Finish
- Precision-Machined 6- and 12-Point Box Ends
- Lever Selector Reverses Drive Without Removing Tool from Fastener

- 2205 • 5-pc. Box End Ratchet Wrenches (SAE): 7/32" x 9/32", 1/4" x 5/16", 3/8" x 7/16", 1/2" x 9/16", 5/8" x 3/4"
 2210 • 5-pc. Box End Ratchet Wrenches (Metric): 5.5 x 7, 6 x 8, 9 x 10, 13 x 14, 16 x 19mm
 2216 • 3-pc. Box End Ratchet Wrenches (SAE): 3/8" x 7/16", 1/2" x 9/16", 5/8" x 3/4"
 2217 • 3-pc. Box End Ratchet Wrenches (Metric): 10 x 12, 13 x 14, 15 x 17mm

Item	Description	Packaging	Cs	In
2205	5-pc. Ratchet Box End Wrench Set (SAE)	Sealed Blister	24	6
2210	5-pc. Ratchet Box End Wrench Set (Metric)	Sealed Blister	24	6
2216	3-pc. Ratchet Offset Box End Wrench Set (SAE)	Sealed Blister	36	6
2217	3-pc. Ratchet Offset Box End Wrench Set (Metric)	Sealed Blister	36	6

Ratcheting Combination Wrench Sets

- Drop Forged, Heat Treated Steel Construction
- Corrosion-Resistant Chrome Plated Finish
- 15-Degree Angle Open End
- 72-Teeth Chrome Vanadium Ratcheting Box End
- Meets or Exceeds ANSI Standards

2100

- 7-pc. Ratcheting Combination Wrenches (SAE): 5/16", 3/8", 7/16", 1/2", 9/16", 5/8", 3/4"
- Complete with Organizer/Storage Rack

2104

- 7-pc. Ratcheting Combination Wrenches (MM): 8, 10, 12, 13, 14, 15, 18 mm
- Complete with Organizer/Storage Rack

2107

- 10-pc. Ratcheting Combination Wrenches (SAE): 1/4", 5/16", 3/8", 7/16", 1/2", 9/16", 5/8", 11/16", 3/4", 7/8"
- Complete with Organizer/Storage Rack

2110

- 10-pc. Ratcheting Combination Wrenches (MM): 8, 9, 10, 11, 12, 13, 15, 17, 18, 19mm
- Complete with Organizer/Storage Rack

Item	Description	Packaging	Cs	In
2100	7-pc. Ratcheting Combination Wrench Set (SAE)	Plastic Hang Rack/Label	20	2
2104	7-pc. Ratcheting Combination Wrench Set (Metric)	Plastic Hang Rack/Label	20	2
2107	10-pc. Ratcheting Combination Wrench Set (SAE)	Plastic Hang Rack/Label	12	2
2110	10-pc. Ratcheting Combination Wrench Set (Metric)	Plastic Hang Rack/Label	12	2



2100 / 2104



2107 / 2110

Individual Combination Wrenches

- Drop Forged, Heat Treated Carbon Steel
- Polished Chrome Plated Finish
- Precision Machined 15° Angled Open End and 12-Point Offset Box End
- Meets or Exceeds ANSI Standards

Item	Description	Packaging	Cs	In
21231	6mm Combination Wrench	Plastic Hang Tab/Label	200	10
21241	7mm Combination Wrench	Plastic Hang Tab/Label	200	10
21251	8mm Combination Wrench	Plastic Hang Tab/Label	200	10
21261	9mm Combination Wrench	Plastic Hang Tab/Label	200	10
21271	10mm Combination Wrench	Plastic Hang Tab/Label	200	10
21281	11mm Combination Wrench	Plastic Hang Tab/Label	200	10
21291	12mm Combination Wrench	Plastic Hang Tab/Label	200	10
21301	13mm Combination Wrench	Plastic Hang Tab/Label	200	10
21311	14mm Combination Wrench	Plastic Hang Tab/Label	200	10
21321	15mm Combination Wrench	Plastic Hang Tab/Label	100	10
21331	16mm Combination Wrench	Plastic Hang Tab/Label	100	10
21341	17mm Combination Wrench	Plastic Hang Tab/Label	100	10
21351	18mm Combination Wrench	Plastic Hang Tab/Label	100	10
21361	19mm Combination Wrench	Plastic Hang Tab/Label	100	10
21371	20mm Combination Wrench	Plastic Hang Tab/Label	50	5
21381	21mm Combination Wrench	Plastic Hang Tab/Label	50	5
21391	22mm Combination Wrench	Plastic Hang Tab/Label	50	5
21401	23mm Combination Wrench	Plastic Hang Tab/Label	50	5
21411	24mm Combination Wrench	Plastic Hang Tab/Label	50	5
21431	1/4" Combination Wrench	Plastic Hang Tab/Label	200	10
21441	5/16" Combination Wrench	Plastic Hang Tab/Label	200	10
21451	3/8" Combination Wrench	Plastic Hang Tab/Label	200	10
21491	7/16" Combination Wrench	Plastic Hang Tab/Label	200	10
21501	1/2" Combination Wrench	Plastic Hang Tab/Label	200	10
21511	9/16" Combination Wrench	Plastic Hang Tab/Label	200	10
21521	5/8" Combination Wrench	Plastic Hang Tab/Label	100	10
21531	11/16" Combination Wrench	Plastic Hang Tab/Label	100	10
21541	3/4" Combination Wrench	Plastic Hang Tab/Label	100	10
21551	13/16" Combination Wrench	Plastic Hang Tab/Label	50	5
21561	7/8" Combination Wrench	Plastic Hang Tab/Label	50	5
21571	15/16" Combination Wrench	Plastic Hang Tab/Label	50	5
21581	1" Combination Wrench	Plastic Hang Tab/Label	50	5
21611	1-1/16" Combination Wrench	Plastic Hang Tab/Label	50	5
21621	1-1/8" Combination Wrench	Plastic Hang Tab/Label	30	5
21631	1-1/4" Combination Wrench	Plastic Hang Tab/Label	30	5



Individual Jumbo Combination Wrenches

- Drop Forged, Heat Treated Carbon Steel
- Corrosion-Resistant Chrome Plated Finish
- 15° Angled Open Ends
- Precision-Machined 12-Point Box Ends
- Raised Panel for Added Strength
- Meets or Exceeds ANSI Standards

Item	Description	Packaging	Cs	In
1951	1-5/16" Jumbo Combination Wrench	Bulk/UPC	24	6
1952	1-3/8" Jumbo Combination Wrench	Bulk/UPC	24	6
1953	1-7/16" Jumbo Combination Wrench	Bulk/UPC	24	6
1954	1-1/2" Jumbo Combination Wrench	Bulk/UPC	24	6
19558	1-3/16" Jumbo Combination Wrench	Bulk/UPC	24	6
19559	1-9/16" Jumbo Combination Wrench	Bulk/UPC	12	4
19560	1-5/8" Jumbo Combination Wrench	Bulk/UPC	12	4
19561	1-11/16" Jumbo Combination Wrench	Bulk/UPC	12	4
19562	1-3/4" Jumbo Combination Wrench	Bulk/UPC	12	4
19563	1-13/16" Jumbo Combination Wrench	Bulk/UPC	12	4
19564	1-7/8" Jumbo Combination Wrench	Bulk/UPC	12	4
19565	2" Jumbo Combination Wrench	Bulk/UPC	6	2
19566	2-1/8" Jumbo Combination Wrench	Bulk/UPC	6	2
19567	2-1/4" Jumbo Combination Wrench	Bulk/UPC	6	2
19568	2-3/8" Jumbo Combination Wrench	Bulk/UPC	6	2
19569	2-1/2" Jumbo Combination Wrench	Bulk/UPC	6	2



26 Wrenches



4-pc. Adjustable Wrench Set

- Drop Forged, Heat Treated Carbon Steel
- Corrosion-Resistant Chrome Plated Finish
- Precision-Machined Jaws for Exact Fit and Smooth Adjustment
- Meets or Exceeds ANSI Standards
- 4-pc. Adjustable Wrenches: 6", 8", 10", 12"
- Complete with Roll-Up Storage Pouch

Wrench Size	Jaw Opening
6"	3/4"
8"	7/8"
10"	1-1/4"
12"	1-3/8"

Stubby Adjustable Wrench

- Drop Forged, Heat Treated Steel
- Corrosion-Resistant Chrome Plated Finish
- Comfortable Non-Slip Soft Handle Grip
- Compact Size for Tight Work Areas
- Meets or Exceeds ANSI Standards

Wrench Size	Jaw Opening
6-1/8"	1"

Item	Description	Packaging	Cs	In	Item	Description	Packaging	Cs	In
2291	4-pc. Adjustable Wrench Set	Color Box	10	1	2293	Stubby Adjustable Wrench	Plastic Hang Tab/Label	48	6

Adjustable Wrenches

- Drop Forged, Heat Treated Carbon Steel
- Corrosion-Resistant Chrome Plated Finish
- Precision-Machined Jaws for Exact Fit and Smooth Adjustment
- Comfortable Cushioned Non-Slip Handle Grip
- Meets or Exceeds ANSI Standards

Item #	Wrench Size	Jaw Opening
2294	4"	5/8"
2300	6"	3/4"
2305	8"	1"
2315	10"	1-1/4"
2325	12"	1-1/2"
2330	15"	1-7/8"

Item	Description	Packaging	Cs	In
2294	4" Adjustable Wrench	Plastic Hang Tab/Label	100	5
2300	6" Adjustable Wrench	Plastic Hang Tab/Label	72	6
2305	8" Adjustable Wrench	Plastic Hang Tab/Label	72	6
2315	10" Adjustable Wrench	Plastic Hang Tab/Label	60	6
2325	12" Adjustable Wrench	Plastic Hang Tab/Label	36	6
2330	15" Adjustable Wrench	Sealed Blister	12	4



Adjustable Wrenches

- Forged and Hardened Chrome Vanadium Steel
- Corrosion-Resistant Black Nickel Finish
- Non-Slip Soft Handle Grip
- Quick Fit SAE / Metric Jaw Opening Guide
- Meets or Exceeds ANSI Standards

Item #	Wrench Size	Jaw Capacity
2301	6"	7/8"
2306	8"	1-1/8"
2316	10"	1-3/8"
2327	12"	1-1/2"

Item	Description	Packaging	Cs	In
2301	6" Adjustable Wrench	Plastic Hang Tab/Label	72	6
2306	8" Adjustable Wrench	Plastic Hang Tab/Label	48	6
2316	10" Adjustable Wrench	Plastic Hang Tab/Label	48	6
2327	12" Adjustable Wrench	Plastic Hang Tab/Label	32	4



Jumbo Adjustable Wrenches

- Drop Forged Carbon Steel
- Heat Treated and Chrome Plated
- Polished Heads
- Smooth Open/Close Roller Action
- Accurate, Precision-Machined Jaws

Item #	Wrench Size	Jaw Opening
2340	18"	2"
2341	24"	2-3/8"

Item	Description	Packaging	Cs	In
2340	18" Jumbo Adjustable Wrench	Bulk/UPC	12	3
2341	24" Jumbo Adjustable Wrench	Bulk/UPC	6	3



Aluminum Pipe Wrenches

- Forged and Hardened Jaws and Nut
- Rugged Cast I-Beam Handle
- Spring Loaded Floating Jaw with Aggressive Teeth for Sure Grip
- Aluminum Construction Weighs 30% Less than Steel

Item #	Wrench Length	Jaw Opening
2361	14"	2-3/4"
2362	18"	3-3/8"
2363	24"	4-1/8"
2364	36"	4"

2368

- 3-pc. Aluminum Pipe Wrenches: 14", 18", 24"
- Complete with Snap-in Carry Case

Item	Description	Packaging	Cs	In
2361	14" Aluminum Pipe Wrench	Wrap or Tie Card	24	4
2362	18" Aluminum Pipe Wrench	Wrap or Tie Card	16	4
2363	24" Aluminum Pipe Wrench	Wrap or Tie Card	12	2
2364	36" Aluminum Pipe Wrench	Wrap or Tie Card	4	1
2368	3-pc. Aluminum Pipe Wrench Set	Color Label	4	1



Pipe Wrenches

- Forged and Hardened Jaws and Nut
- Rugged Cast I-Beam Handle
- Spring Loaded Floating Jaw with Aggressive Teeth for Sure Grip

Item #	Wrench Length	Jaw Opening
2370	8"	1-1/8"
2376	10"	1-7/8"
2381	14"	2-1/4"
2386	18"	3-1/8"

2365

- 4-pc. Pipe Wrenches: 8", 10", 14", 18"

Item	Description	Packaging	Cs	In
2365	4-pc. Pipe Wrench Set	Color Box	4	1
2370	8" Pipe Wrench	Wrap or Tie Card	36	6
2376	10" Pipe Wrench	Wrap or Tie Card	24	6
2381	14" Pipe Wrench	Wrap or Tie Card	12	3
2386	18" Pipe Wrench	Wrap or Tie Card	6	2



Jumbo Pipe Wrenches

- Forged and Hardened Jaws and Nut
- Rugged Cast I-Beam Handle
- Spring Loaded Floating Jaw with Aggressive Teeth for Sure Grip

Item #	Wrench Length	Jaw Opening
2390	24"	3-3/4"
2395	24"	4"

Item	Description	Packaging	Cs	In
2390	24" Pipe Wrench	Wrap or Tie Card	4	2
2395	36" Pipe Wrench	Wrap or Tie Card	4	2



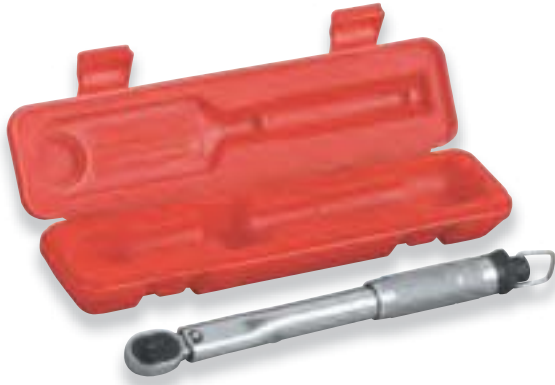

1/4" Drive Click Torque Wrench

- Hardened Alloy Steel Handle
- Reversible Drive, Forged Chrome Vanadium Steel Ratchet Head
- Corrosion-Resistant Chrome Plated Finish
- Locking Micrometer Torque Adjustment with Non-Slip Knurled Grip
- Wrench Clicks when Torque Setting is Reached
- Meets or Exceeds Federal Specification GGG-W00686C

Specifications:

- Ratchet: CR-V, 24 Tooth
- Length: 10"
- Dual Range: 20-200 inch/lb. / 23-230 cm/kg
- Increment: 1 inch/lb. / 0.53 cm/kg
- Calibration: +/- 4%
- 1-pc. 1/4" Drive Torque Wrench
- 1-pc. Storage Case
- Instruction Sheet / Torque Conversion Chart

Item	Description	Packaging	Cs	In
2432	1/4" Drive Click Torque Wrench	Color Box	20	5

3/8" Drive Click Torque Wrench

- Hardened Alloy Steel Handle
- Reversible Drive, Forged Chrome Vanadium Steel Ratchet Head
- Corrosion-Resistant Chrome Plated Finish
- Locking Micrometer Torque Adjustment with Non-Slip Knurled Grip
- Wrench Clicks when Torque Setting is Reached
- Meets or Exceeds Federal Specification GGG-W00686C

Specifications:

- Ratchet: CR-V, 44 Tooth
- Length: 10"
- Dual Range: 120-960 inch/lb. / 1.4-11.1 m/kg
- Increment: 12 inch/lb. / 0.14 m/kg
- Calibration: +/- 4%

Item	Description	Packaging	Cs	In
2435	3/8" Drive Click Torque Wrench	Slide Blister Card	20	5

3/8" Drive Click Torque Wrench

- Hardened Alloy Steel Handle
- Reversible Drive, Forged Chrome Vanadium Steel Ratchet Head
- Corrosion-Resistant Chrome Plated Finish
- Locking Micrometer Torque Adjustment with Non-Slip Knurled Grip
- Wrench Clicks when Torque Setting is Reached
- Meets or Exceeds Federal Specification GGG-W00686C

Specifications:

- Ratchet: CR-V, 45 Tooth
- Length: 10"
- Dual Range: 120-960 inch/lb. / 1.4-11.1 m/kg
- Increment: 12 inch/lb. / 0.14 m/kg
- Calibration: +/- 4%
- 1-pc. 3/8" Drive Torque Wrench
- 1-pc. 3/8" Dr. (F) x 1/2 Dr. (M) Adapter
- 1-pc. Storage Case
- Instruction Sheet / Torque Conversion Chart

Item	Description	Packaging	Cs	In
2455	3/8" Drive Click Torque Wrench	Color Box	20	5



1/2" Drive Click Torque Wrench

- Hardened Alloy Steel Handle
- Reversible Drive, Forged Chrome Vanadium Steel Ratchet Head
- Corrosion-Resistant Chrome Plated Finish
- Locking Micrometer Torque Adjustment with Non-Slip Knurled Grip
- Wrench Clicks when Torque Setting is Reached
- Meets or Exceeds Federal Specification GGG-W00686C

Specifications:

- Ratchet: CR-V, 24 Tooth
- Length: 18"
- Dual Range: 20-150 ft./lb. / 2.8-20.7 m/kg
- Increment: 1 ft./lb. / 0.14 m/kg
- Calibration: +/- 4%

Item	Description	Packaging	Cs	In
2440	1/2" Drive Click Torque Wrench	Slide Blister Card	12	6



1/2" Drive Click Torque Wrench

- Hardened Alloy Steel Handle
- Reversible Drive, Forged Chrome Vanadium Steel Ratchet Head
- Corrosion-Resistant Chrome Plated Finish
- Locking Micrometer Torque Adjustment with Non-Slip Knurled Grip
- Wrench Clicks when Torque Setting is Reached
- Meets or Exceeds Federal Specification GGG-W00686C

Specifications:

- Ratchet: CR-V, 24 Tooth
- Length: 18"
- Dual Range: 20-150 ft./lb. / 2.8-20.7 m/kg
- Increment: 1 ft./lb. / 0.14 m/kg
- Calibration: +/- 4%
- 1-pc. 1/2" Drive Torque Wrench
- 1-pc. 1/2" Dr. (F) x 3/8" Dr. (M) Reducer
- 1-pc. 1/2" Dr. 5" Extension Bar
- 1-pc. Storage Case
- Instruction Sheet / Torque Conversion Chart

Item	Description	Packaging	Cs	In
2460	1/2" Drive Click Torque Wrench	Color Box	12	1



1/2" Drive Click Torque Wrench (250 ft.-lb.)

- Hardened Alloy Steel Handle
- Reversible Drive, Forged Chrome Vanadium Steel Ratchet Head
- Corrosion-Resistant Chrome Plated Finish
- Locking Micrometer Torque Adjustment with Non-Slip Knurled Grip
- Wrench Clicks when Torque Setting is Reached
- Meets or Exceeds Federal Specification GGG-W00686C

Specifications:

- Ratchet: CR-V, 24 Tooth
- Length: 24"
- Dual Range: 25-250 ft./lb. / 3.5-34.5 m/kg
- Increment: 1 ft./lb. / 0.14 m/kg
- Calibration: +/- 4%

Item	Description	Packaging	Cs	In
2445	1/2" Drive Click Torque Wrench (250 ft.-lb.)	Color Box	10	1



Crowfoot Wrench Sets

- Drop Forged, Heat Treated Carbon Steel Construction
- Corrosion-Resistant Chrome Plated Finish

2575

- 10-pc. 3/8" Dr. Crowfoot Wrenches (SAE): 3/8", 7/16", 1/2", 9/16", 5/8", 11/16", 3/4", 13/16", 7/8", 1"
- Includes Hanging Storage Rail

2580

- 10-pc. 3/8" Dr. Crowfoot Wrenches (Metric): 10, 11, 13, 14, 15, 17, 19, 21, 22, 24mm
- Includes Hanging Storage Rail

2585

- 14-pc. 1/2" Dr. Crowfoot Wrenches (SAE): 1-1/16", 1-1/8", 1-3/16", 1-1/4", 1-5/16", 1-3/8", 1-7/16", 1-1/2", 1-5/8", 1-11/16", 1-3/4", 1-13/16", 1-7/8", 2"
- Complete with Snap-in Storage Tray

Item	Description	Packaging	Cs	In
2575	10-pc. 3/8" Drive Crowfoot Wrench Set (SAE)	Slide Blister Card	30	6
2580	10-pc. 3/8" Drive Crowfoot Wrench Set (Metric)	Slide Blister Card	30	6
2585	14-pc. 1/2" Drive Jumbo Crowfoot Wrench Set (SAE)	Color Box	4	1



Folding Hex Key Wrench Sets



- 25151**
- 9-pc. Hex (SAE): 5/64, 3/32, 7/64, 1/8, 9/64, 5/32, 3/16, 7/32, 1/4"
- 25161**
- 8-pc. Hex (Metric): 1.5, 2, 2.5, 3, 4, 5, 6, 8mm

- Rugged, Black Oxide Finished Chrome Vanadium Steel Wrenches
- Heavy Duty Color-Coded Housing
- Textured Non-Slip Grips

Folding Star Key Wrench Sets

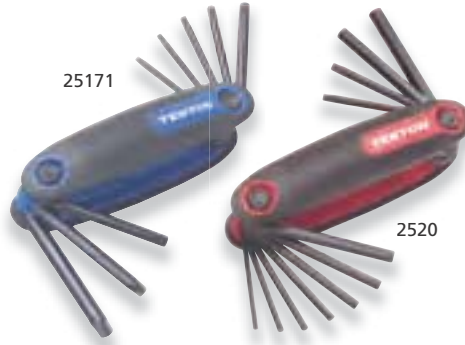

- 25171**
- 8-pc. Star (SAE): SD-9, SD-10, SD-15, SD-20, SD-25, SD-27, SD-30, SD-40
- 2520**
- 9-pc. Hex (SAE): 5/64, 3/32, 7/64, 1/8, 9/64, 5/32, 3/16, 7/32, 1/4"
 - 2-pc. Star: SD-15, SD-20

Item	Description	Packaging	Cs	In
25151	9-pc. Folding Hex Key Wrench Set (SAE)	Hang Card	24	4
25161	8-pc. Folding Hex Key Wrench Set (Metric)	Hang Card	24	4
25171	8-pc. Folding Star Key Wrench Set	Hang Card	24	4
2520	11-pc. Folding Hex and Star Key Wrench Clip	Hang Card	36	6
25181	9-pc. Folding Ball Hex Key Wrench Set (SAE)	Hang Card	24	4
25191	8-pc. Folding Ball Hex Key Wrench Set (Metric)	Hang Card	24	4

Folding Ball Hex Key Wrench Sets



- 25181**
- 9-pc. Ball Hex (SAE): 5/64, 3/32, 7/64, 1/8, 9/64, 5/32, 3/16, 7/32, 1/4"
- 25191**
- 8-pc. Ball Hex (MM): 1.5, 2, 2.5, 3, 4, 5, 6, 8mm

13-pc. Short Arm Hex Key Wrench Sets

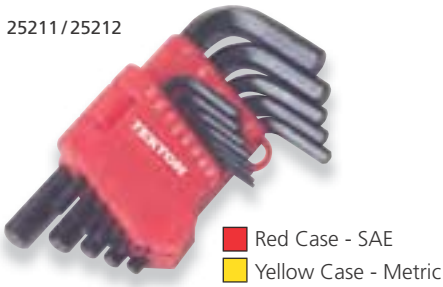

- Short Arm Wrenches Access Fasteners in Tight Spaces

- 25211**
- 13-pc. Short Arm (SAE): .05, 1/16, 5/64, 3/32, 7/64, 1/8, 9/64, 5/32, 3/16, 7/32, 1/4, 5/16, 3/8"
- 25212**
- 13-pc. Short Arm (MM): 1.27, 1.5, 2, 2.5, 3, 3.5, 4, 4.5, 5, 5.5, 6, 8, 10mm

- Rugged, Black Oxide Finished Chrome Vanadium Steel Wrenches
- Color-Coded Storage Case Keeps Wrenches Organized
- Short Arm Wrenches Access Fasteners in Tight Spaces

9-pc. Long Arm Hex Key Wrench Sets

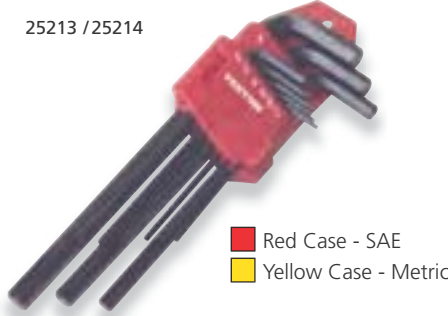

- Long Arm Wrenches for Extra Reach and Greater Torque

- 25213**
- 9-pc. (SAE): 1/16, 5/64, 3/32, 1/8, 5/32, 3/16, 1/4, 5/16, 3/8"
- 25214**
- 9-pc. (MM): 1.5, 2, 2.5, 3, 4, 5, 6, 8, 10mm

Item	Description	Packaging	Cs	In
25211	13-pc. Short Arm Hex Key Wrench Set (SAE)	Slide Blister Card	48	4
25212	13-pc. Short Arm Hex Key Wrench Set (Metric)	Slide Blister Card	48	4
25213	9-pc. Long Arm Hex Key Wrench Set (SAE)	Slide Blister Card	24	4
25214	9-pc. Long Arm Hex Key Wrench Set (Metric)	Slide Blister Card	24	4
25217	13-pc. Long Arm Hex Key Wrench Set (SAE)	Slide Blister Card	24	4
25218	13-pc. Long Arm Hex Key Wrench Set (Metric)	Slide Blister Card	24	4

13-pc. Long Arm Hex Key Wrench Sets



- 25217**
- 13-pc. Long Arm (SAE): .05, 1/16, 5/64, 3/32, 7/64, 1/8, 9/64, 5/32, 3/16, 7/32, 1/4, 5/16, 3/8"
- 25218**
- 13-pc. Long Arm (MM): 1.27, 1.5, 2, 2.5, 3, 3.5, 4, 4.5, 5, 5.5, 6, 8, 10mm

9-pc. Long Arm Ball Hex Key Wrench Sets



13-pc. Long Arm Ball Hex Key Wrench Sets



• Long Arm Wrenches for Extra Reach and Greater Torque

25215

- 9-pc. (SAE): 1/16, 5/64, 3/32, 1/8, 5/32, 3/16, 1/4, 5/16, 3/8"

25216

- 9-pc. (MM): 1.5, 2, 2.5, 3, 4, 5, 6, 8, 10mm

- Rugged, Black Oxide Finished Chrome Vanadium Steel Wrenches
- Color-Coded Storage Case Keeps Wrenches Organized
- Long Arm Wrenches for Extra Reach and Greater Torque
- Ball Hex Ends Allow up to a 25° Offset for Easy Access to Fasteners

25219

- 13-pc. (SAE): .05, 1/16, 5/64, 3/32, 7/64, 1/8, 9/64, 5/32, 3/16, 7/32, 1/4, 5/16, 3/8"

25220

- 13-pc. (MM): 1.27, 1.5, 2, 2.5, 3, 3.5, 4, 4.5, 5, 5.5, 6, 8, 10mm

Item	Description	Packaging	Cs	In
25215	9-pc. Long Arm Ball Hex Key Wrench Set (SAE)	Slide Blister Card	24	4
25216	9-pc. Long Arm Ball Hex Key Wrench Set (Metric)	Slide Blister Card	24	4
25219	13-pc. Long Arm Ball Hex Key Wrench Set (SAE)	Slide Blister Card	24	4
25220	13-pc. Long Arm Ball Hex Key Wrench Set (Metric)	Slide Blister Card	24	4



22-pc. Long Arm Hex Key Wrench Set (SAE/Metric)

- Rugged, Black Oxide Finished Chrome Vanadium Steel Wrenches
- Color-Coded Storage Cases Keep Wrenches Organized
- Long Arm Wrenches for Extra Reach and Greater Torque
- 13-pc. Hex Key Wrenches (SAE): .05, 1/16, 5/64, 3/32, 7/64, 1/8, 9/64, 5/32, 3/16, 7/32, 1/4, 5/16, 3/8"
- 9-pc. Hex Key Wrenches (Metric): 1.5, 2, 2.5, 3, 4, 5, 6, 8, 10mm

Item	Description	Packaging	Cs	In
25221	22-pc. Long Arm Hex Key Wrench Set (SAE/Metric)	Sealed Blister	24	3



25-pc. Folding Hex Key Wrench Set (SAE/Metric/Star)

- Rugged, Black Oxide Finished Chrome Vanadium Steel Wrenches
- Heavy Duty Color-Coded Housings
- Textured Non-Slip Rubberized Grips

- 9-pc. Hex Key Wrenches (SAE): 5/64", 3/32", 7/64", 1/8", 9/64", 5/32", 3/16", 7/32", 1/4"
- 8-pc. Hex Key Wrenches (Metric): 1.5, 2, 2.5, 3, 4, 5, 6, 8mm
- 8-pc. Star Key Wrenches: SD-9, 10, 15, 20, 25, 27, 30, 40

Item	Description	Packaging	Cs	In
25222	25-pc. Folding Hex Key Wrench Set (SAE/Metric/Star)	Hang Card	24	6



22-pc. Long Arm Ball Hex Key Wrench Set (SAE/Metric) - Bonus Pick Up

- Rugged, Black Oxide Finished Chrome Vanadium Steel Wrenches
 - Color-Coded Storage Case Keeps Wrenches Organized
 - Long Arm Wrenches for Extra Reach and Greater Torque
 - Ball Hex Ends Allow up to a 25° Offset for Easy Access to Fasteners
 - 13-pc. (SAE): .05, 1/16, 5/64, 3/32, 7/64, 1/8, 9/64, 5/32, 3/16, 7/32, 1/4, 5/16, 3/8"
 - 9-pc. (MM): 1.5, 2, 2.5, 3, 4, 5, 6, 8, 10mm
- BONUS - Telescoping Magnetic Pick-Up Tool**
- Retrieves Ferrous Metal Objects up to 1/4 lb.
 - Dual Ball Joint Positions Magnet at any Angle
 - Telescopes from 6" to 18"
 - Pen Size Tool with Pocket Clip

BONUS

- 1/4 Lb. Telescoping Magnetic Pick-up Tool

Item	Description	Packaging	Cs	In
25223	22-pc. Long Arm Ball Hex Key Wrench Set (SAE/Metric) - Bonus Pick Up	Sealed Blister	24	4



14-pc. Hex Key Wrench Set (SAE/Metric)

- Heat Treated Carbon Steel Construction
- Chrome Plated (SAE) and Black Oxide (Metric) Finishes Resist Corrosion
- Key Ring Organizer with Removable Spring Wrench Retainers
- 7-pc. Hex Key Wrenches (SAE): - 1/16", 5/64", 3/32", 1/8", 5/32", 3/16", 7/32"
- 7-pc. Hex Key Wrenches (Metric): - 1.5, 2, 2.5, 3, 4, 5.5, 6mm

Item	Description	Packaging	Cs	In
2500	14-pc. Hex Key Wrench Set (SAE/Metric)	Blister Card	72	12



25-pc. Hex Key Wrench Set (SAE/Metric)

- Heat Treated Carbon Steel Construction
- Black Oxide Finish Resists Corrosion
- Long Arm SAE Sizes and Short Arm Metric Sizes
- 12-pc. Long Arm (SAE): 0.05, 1/16, 5/64, 3/32, 7/64, 1/8, 9/64, 5/32, 3/16, 7/32, 1/4, 5/16, 3/8"
- 13-pc. Short Arm (Metric): 1.3, 1.5, 2, 2.5, 3, 4, 5, 5.5, 6, 7, 8, 10mm
- Complete with Storage/Organizer Pouch

Item	Description	Packaging	Cs	In
2512	25-pc. Hex Key Wrench Set (SAE/Metric)	Pouch/Color Label	20	10



6-pc. Jumbo Hex Key Wrench Sets

- Heat Treated Chrome Vanadium Steel
- Black Oxide Finish Resists Corrosion
- 6-pc. Wrenches (SAE): 3/8", 7/16", 1/2", 9/16", 5/8", 3/4"
- Complete with Snap-in Carry Case
- 6-pc. Wrenches (Metric): 8, 10, 12, 14, 17, 19mm
- Complete with Snap-in Carry Case

Item	Description	Packaging	Cs	In
2535	6-pc. Jumbo Hex Key Wrench Set (SAE)	Color Label	12	3
2540	6-pc. Jumbo Hex Key Wrench Set (Metric)	Color Label	12	3



10-pc. T-Handle Hex Key Wrench Sets

- Heat Treated Extruded Alloy Steel
- Black Oxide Finish for Durability
- Contoured Plastic T-Handles
- T-Handle Design Increases Turning Power and Provides a Sure Comfortable Grip
- Color Coded Handles for Easy Size Selection
- 10-pc. Wrenches (SAE): 3/32", 7/64", 1/8", 9/64", 5/32", 3/16", 7/32", 1/4", 5/16", 3/8"
- Complete with Handy Steel Index Stand
- 10-pc. Wrenches (Metric): 2, 2.5, 3, 4, 4.5, 5, 5.5, 6, 8, 10mm
- Complete with Handy Steel Index Stand

Item	Description	Packaging	Cs	In
2546	10-pc. T-Handle Hex Key Wrench Set (SAE)	Sealed Blister	12	6
2547	10-pc. T-Handle Hex Key Wrench Set (Metric)	Sealed Blister	12	6

3-pc. Flare Nut Wrench Sets

- Drop Forged, Heat Treated Carbon Steel Construction
- Corrosion-Resistant Chrome Plated Finish
- 15-Degree Offset Ends
- Use for Connection Fittings on Fuel, Brake, and Air Conditioning Lines
- Meets or Exceeds ANSI Standards

2640

- 3-pc. Wrenches (SAE): 3/8" x 7/16", 1/2" x 9/16", 5/8" x 11/16"

2645

- 3-pc. Wrenches (Metric): 10 x 12, 13 x 14, 15 x 17mm



Item	Description	Packaging	Cs	In
2640	3-pc. Flare Nut Wrench Set (SAE)	Slide Blister Card	50	5
2645	3-pc. Flare Nut Wrench Set (Metric)	Slide Blister Card	50	5

6-pc. Flare Nut Wrench Sets

- Drop Forged, Heat Treated Carbon Steel Construction
- Corrosion-Resistant Chrome Plated Finish
- 15-Degree Offset Ends
- Use for Connection Fittings on Fuel, Brake, and Air Conditioning Lines
- Meets or Exceeds ANSI Standards

2650

- 6-pc. Wrenches (SAE): 1/4" x 5/16", 3/8" x 7/16", 1/2" x 9/16", 5/8" x 11/16", 3/4" x 13/16", 7/8" x 1"

2655

- 6-pc. Wrenches (Metric): 6 x 8, 10 x 12, 13 x 14, 15 x 17, 19 x 21, 22 x 24mm



Item	Description	Packaging	Cs	In
2650	6-pc. Flare Nut Wrench Set (SAE)	Slide Blister Card	20	5
2655	6-pc. Flare Nut Wrench Set (Metric)	Slide Blister Card	20	5



12" Basin Wrench

- Hardened Steel Jaws with Aggressive Teeth
- Chrome Plated Finish Resists Corrosion
- Spring-Loaded Swivel Jaw Automatically Adjusts to Size to Grip Hard-to-Reach Fittings
- Sliding T-Handle

Item	Description	Packaging	Cs	In
2672	12" Basin Wrench	Hang Card	40	5



12-Slot Wrench Organizer

- Twelve Spring-Loaded Slots Grip and Hold Wrenches for Carrying and Storage
- Heat Treated Steel with Chip-Resistant Finish
- Carry Handle with Comfortable Soft Grip
- Two Keyhole Slots for Mounting on Wall or Workbench

Item	Description	Packaging	Cs	In
2685	12-Slot Wrench Organizer	Color Sleeve	72	6

34 Screwdrivers



8-pc. Mechanic's Screwdriver Set

- Hardened and Tempered Carbon Steel Shafts
- Durable Chrome Plated Finish Resists Corrosion
- Precision-Machined Vapor Blasted Magnetized Tips
- Comfortable Mechanic's-Style Handles
- Hex Bolster for Wrench-Assisted Torque (on Most Sizes)
- 5-pc. Flat: 1/4" x 1-1/2", 3/16" x 3", 1/4" x 4", 5/16" x 6", 3/8" x 8"
- 3-pc. Phillips: #2 x 1-1/2", #1 x 3", #2 x 4"

Item	Description	Packaging	Cs	In
2757	8-pc. Mechanic's Screwdriver Set	Sealed Blister	20	5



2-pc. Mechanic's Screwdriver Set

- Hardened and Tempered Carbon Steel Shafts
- Durable Chrome Plated Finish Resists Corrosion
- Precision-Machined Vapor Blasted Magnetized Tips
- Comfortable Mechanic's-Style Handles
- 1-pc. Flat: 1/4" x 4"
- 1-pc. Phillips: #2 x 4"

Item	Description	Packaging	Cs	In
2762	2-pc. Mechanic's Screwdriver Set	Slide Blister Card	72	12



4-pc. Mechanic's Screwdriver Set

- Hardened and Tempered Carbon Steel Shafts
- Durable Chrome Plated Finish Resists Corrosion
- Precision-Machined Vapor Blasted Magnetized Tips
- Comfortable Mechanic's-Style Handles
- 2-pc. Flat: 3/16" x 3", 1/4 x 4"
- 2-pc. Phillips: #1 x 3", #2 x 4"

Item	Description	Packaging	Cs	In
2763	4-pc. Mechanic's Screwdriver Set	Slide Blister Card	72	6



5-pc. Mechanic's Screwdriver Set

- Hardened and Tempered Carbon Steel Shafts
- Durable Chrome Plated Finish Resists Corrosion
- Precision-Machined Vapor Blasted Magnetized Tips
- Comfortable Mechanic's-Style Handles
- Hex Bolster for Wrench-Assisted Torque (on Most Sizes)
- 3-pc. Flat: 3/16" x 3", 1/4" x 4", 5/16" x 6"
- 2-pc. Phillips: #1 x 3", #2 x 4"

Item	Description	Packaging	Cs	In
2764	5-pc. Mechanic's Screwdriver Set	Slide Blister Card	40	5



6-pc. Star Drive Screwdriver Set

- Hardened and Tempered Chrome Vanadium Steel Shafts
- Durable Chrome Plated Finish Resists Corrosion
- Precision-Machined Vapor Blasted and Magnetized Tips
- Comfortable Mechanic's-Style Handles
- 6-pc. Star Drive Screwdrivers: SD-10, SD-15, SD-20, SD-25, SD-27, SD-30
- Complete with Storage Rack and Mounting Screws

Item	Description	Packaging	Cs	In
2956	6-pc. Star Drive Screwdriver Set	Slide Blister Card	24	6

2-pc. Stubby Screwdriver Set

- High-Strength, Heat Treated Chrome Vanadium Steel Shafts
- Corrosion-Resistant Chrome Plated Finish
- Comfortable HexTorque Handles with Non-Slip Rubber Grips
- Magnetized Tips Prevent Dropped Fasteners
- Meets or Exceeds ANSI Standards
- 1-pc. Flat 3/16" x 1-1/2"
- 1-pc. Phillips #2 x 1-1/2"

Item	Description	Packaging	Cs	In
2740	2-pc. Stubby Screwdriver Set	Sealed Blister	80	10



4-pc. Screwdriver Set

- High-Strength, Heat Treated Chrome Vanadium Steel Shafts
- Corrosion-Resistant Chrome Plated Finish
- Comfortable HexTorque Handles with Non-Slip Rubber Grips
- Magnetized Tips Prevent Dropped Fasteners
- Meets or Exceeds ANSI Standards
- 2-pc. Flat: 1/8" x 3", 3/16" x 4"
- 2-pc. Phillips: #1 x 3", #2 x 4"

Item	Description	Packaging	Cs	In
2741	4-pc. Screwdriver Set	Sealed Blister	36	6



6-pc. Screwdriver Set

- High-Strength, Heat Treated Chrome Vanadium Steel Shafts
- Corrosion-Resistant Chrome Plated Finish
- Comfortable HexTorque Handles with Non-Slip Rubber Grips
- Magnetized Tips Prevent Dropped Fasteners
- Meets or Exceeds ANSI Standards
- 3-pc. Flat: 1/8" x 3", 3/16" x 4", 1/4" x 6"
- 3-pc. Phillips: #0 x 3", #1 x 4", #2 x 6"
- Complete with Hanging Storage Rack (Hardware Included)

Item	Description	Packaging	Cs	In
2742	6-pc. Screwdriver Set	Sealed Blister	24	6



15-pc. Screwdriver Set

- 7-pc. Screwdriver Set
- High-Strength, Heat Treated Chrome Vanadium Steel Shafts
 - Corrosion-Resistant Chrome Plated Finish
 - Comfortable HexTorque Handles with Non-Slip Rubber Grips
 - Magnetized Tips Prevent Dropped Fasteners
 - Meets or Exceeds ANSI Standards
- 8-pc. Precision Screwdriver Set
- High-Strength, Heat Treated Chrome Vanadium Steel Shafts
 - Corrosion-Resistant Chrome Plated Finish
 - Comfortable Handles with Non-Slip Rubber Grips
 - Swivel End Cap Allows Constant Finger Pressure while Driving
 - Magnetized Tips Prevent Dropped Fasteners
 - Meets or Exceeds ANSI Standards
- 7-pc. Screwdriver Set
- 4-pc. Flat: 1/4" Stubby, 3/16" x 3", 1/4" x 4", 5/16" x 5"
 - 3-pc. Phillips: #2 Stubby, #1 x 3", #2 x 4"
- 8-pc. Precision Screwdriver Set
- 2-pc. Flat: 1.5mm, 2.0mm
 - 2-pc. Phillips: #000, #00
 - 4-pc. Star: SD-5, SD-6, SD-7, SD-8

Item	Description	Packaging	Cs	In
2744	15-pc. Screwdriver Set	Sealed Blister	24	6



36 Screwdrivers

54-pc. Screwdriver Set

- Three Screwdriver Sets in One: Ratchet Driver and Bits, Standard, Precision

RATCHET DRIVER SET

- 3-Position Ratchet Drive (Forward, Fixed and Reverse) and Bit Storage Compartment in Handle
- Precision-Milled Chrome Vanadium Steel Bits

STANDARD SCREWDRIVER SET

- Hardened Chrome Vanadium Steel Shafts with Corrosion-Resistant Finish
- Comfortable Non-Slip, Soft Handle Grips

PRECISION SCREWDRIVER SET

- Hardened Chrome Vanadium Steel Shafts with Corrosion-Resistant Finish
- Comfortable Non-Slip, Soft Handle Grips
- Free Spinning End Cap Allows Constant Finger Pressure While Turning

RATCHET DRIVER SET

- 1-pc. Ratchet Screwdriver
- 30-pc. Screwdriver Bits:
 - 8-pc. Flat: 3/32", 1/8", 5/32", 3/16", 7/32", 1/4", 9/32", 5/16"
 - 2-pc. Hex: 1/8", 3/16"
 - 7-pc. Phillips: #0, #1, #2 (4-pc.), #3
 - 3-pc. Pozi: #1, #2 (2-pc.)
 - 4-pc. Square: #1, #2 (2-pc.), #3
 - 6-pc. Star: SD-10, SD-15, SD-20, SD-25, SD-27, SD-30
 - 10-pc. Nut Driver Bits: 5/32", 3/16", 7/32", 1/4", 9/32", 5/16", 11/32", 3/8", 7/16", 1/2"

STANDARD SCREWDRIVER SET

- 4-pc. Flat: 1/4" Stubby, 3/16" x 3", 1/4" x 4", 1/4" x 6"
- 3-pc. Phillips: #2 Stubby, #1 x 3", #2 x 4"

PRECISION SCREWDRIVER SET

- 3-pc. Flat: 1.5mm, 2.0mm, 2.5mm
- 3-pc. Phillips: #00, #0, #1

Item	Description	Packaging	Cs	In
2769	54-pc. Screwdriver Set	Sealed Blister/Display Box	12	6



- AVAILABLE IN DISPLAY QUANTITIES ONLY





6-pc. Screwdriver Set

- Hardened Carbon Steel Shafts
 - Corrosion-Resistant Chrome Plated Finish
 - Precision-Machined Magnetized Tips
 - Sure Grip 4-Flute Handles
- 3-pc. Flat: 3/16" x 3", 1/4" x 4", 3/16" x 6"
 - 3-pc. Phillips: #1 x 3", #2 x 4", #1 x 6"

Item	Description	Packaging	Cs	In
2721	6-pc. Screwdriver Set	Slide Blister Card	48	6



6-pc. Screwdriver Set

- Hardened Chrome Vanadium Steel Shafts
 - Magnetized Tips Prevent Dropped Fasteners
 - Corrosion-Resistant Chrome Plated Finish
 - Comfortable Non-Slip Soft Grip Triple Torque™ Handles
 - Ready-to-Mount Workbench Storage Rack
- Flat: 1/4" Stubby, 3/16" x 3", 1/4" x 4"
 - Phillips: #2 Stubby, #1 x 3", #2 x 4"

Item	Description	Packaging	Cs	In
2767	6-pc. Screwdriver Set	Sealed Blister	24	6



Extra Long Screwdrivers

- Heat Treated Chrome Vanadium Steel Shaft
- Durable Chrome Plated Finish Resists Corrosion
- Precision-Machined Vapor Blasted Tip
- Cushioned Non-Slip Handle Grip

Item	Description	Packaging	Cs	In
2772	20" x 1/4" Flat Extra Long Screwdriver	Color Label	48	6
2773	20" x #2 Phillips Extra Long Screwdriver	Color Label	48	6

3-pc. Offset Screwdriver Set

- Heat Treated Carbon Steel Construction
 - Corrosion-Resistant Chrome Plated Finish
 - Non-Slip Knurled Handles
 - Reaches Fasteners Around Obstructions and in Tight Work Areas
- 1-pc. #1 Phillips x 3/16" Flat
 - 1-pc. #2 Phillips x 1/4" Flat
 - 1-pc. #3 Phillips x 5/16" Flat

Item	Description	Packaging	Cs	In
2944	3-pc. Offset Screwdriver Set	Slide Blister Card	100	10





4-pc. Screwdriver Set

- Rugged Professional-Grade Chrome Molybdenum Steel
- 6-Flute Handle Design Provides Maximum Grip and Torque
- Triple Chrome-Plated Shafts and Blades Resist Corrosion
- Accurately Machined Tips for Precise Fit in Fasteners
- Magnetized Tips Help Prevent Dropped Fasteners

- 2-pc. Flat: 3/16" x 3", 1/4" x 4"
- 2-pc. Phillips: #1 x 3", #2 x 4"

Item	Description	Packaging	Cs	In
27040	4-pc. Screwdriver Set	Sealed Blister	40	4



8-pc. Screwdriver Set

- Rugged Professional-Grade Chrome Molybdenum Steel
- 6-Flute Handle Design Provides Maximum Grip and Torque
- Triple Chrome-Plated Shafts and Blades Resist Corrosion
- Accurately Machined Tips for Precise Fit in Fasteners
- Magnetized Tips Help Prevent Dropped Fasteners

- 4-pc. Flat: 3/16" x 3", 1/4" Stubby, 1/4" x 4", 1/4" x 6"
- 4-pc. Phillips: #1 x 3", #2 Stubby, #2 x 4", #2 x 6"

Item	Description	Packaging	Cs	In
27041	8-pc. Screwdriver Set	Sealed Blister	24	6

16-pc. Screwdriver Set

- Rugged Professional-Grade Chrome Molybdenum Steel
- 6-Flute Handle Design Provides Maximum Grip and Torque
- Triple Chrome-Plated Shafts and Blades Resist Corrosion
- Accurately Machined Tips for Precise Fit in Fasteners
- Magnetized Tips Help Prevent Dropped Fasteners

- 7-pc. Flat: 1/8" x 3" Pocket, 3/16" x 3", 3/16" x 4", 1/4" x 4", 1/4" x 6", 5/16" x 6", 1/4" Stubby
- 6-pc. Phillips: #0 x 3" Pocket, #1 x 3", #2 Stubby, #2 x 4", #2 x 6", #3 x 6"
- 3-pc. Specialty: #1 Ph. x 3/16" Flat Offset, #2 Ph. x 1/4" Flat Offset, 4-Way Flat Keychain Screwdriver



Item	Description	Packaging	Cs	In
27042	16-pc. Screwdriver Set	Sealed Blister	12	6

Professional Screwdrivers

- Vapor Blasted Magnetized Tips
- Ribbed Tips Increase Grip on Fastener and Reduce Cam-Out (Flat Sizes)

- Full Size 6-Flute Handles for Sure Grip

- Heat Treated Chrome Molybdenum Steel Shafts are Triple Chrome Plated for Extra Durability

Tip Types Available in the Professional Series

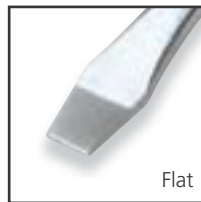

Flat



Phillips



Robertson



Awl

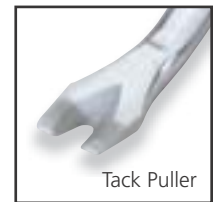

Tack Puller



Item	Description	Packaging	Cs	In
27000	1/4" Flat Stubby Screwdriver	Plastic Hang Tab/Label	72	6
27001	1/8" x 3-1/2" Flat Pocket Screwdriver	Plastic Hang Tab/Label	72	6
27002	1/8" Flat x 3" Screwdriver	Plastic Hang Tab/Label	72	6
27003	3/16" Flat x 3" Screwdriver	Plastic Hang Tab/Label	72	6
27004	3/16" Flat x 4" Screwdriver	Plastic Hang Tab/Label	72	6
27005	1/4" Flat x 4" Screwdriver	Plastic Hang Tab/Label	72	6
27006	3/16" Flat x 6" Screwdriver	Plastic Hang Tab/Label	72	6
27007	1/4" Flat x 6" Screwdriver	Plastic Hang Tab/Label	72	6
27008	5/16" Flat x 6" Screwdriver	Plastic Hang Tab/Label	72	6
27009	3/16" Flat x 8" Screwdriver	Plastic Hang Tab/Label	72	6
27010	3/8" Flat x 8" Screwdriver	Plastic Hang Tab/Label	72	6
27011	3/16" Flat x 10" Screwdriver	Plastic Hang Tab/Label	72	6
27012	#2 Ph Stubby Screwdriver	Plastic Hang Tab/Label	72	6
27013	#0 Ph x 3" Screwdriver	Plastic Hang Tab/Label	72	6
27014	#1 Ph x 3" Screwdriver	Plastic Hang Tab/Label	72	6
27015	#2 Ph x 4" Screwdriver	Plastic Hang Tab/Label	72	6
27016	#1 Ph x 6" Screwdriver	Plastic Hang Tab/Label	72	6
27017	#2 Ph x 6" Screwdriver	Plastic Hang Tab/Label	72	6
27018	#3 Ph x 6" Screwdriver	Plastic Hang Tab/Label	72	6
27022	#1 Robertson x 4" Screwdriver	Plastic Hang Tab/Label	72	6
27023	#2 Robertson x 4" Screwdriver	Plastic Hang Tab/Label	72	6
27024	#3 Robertson x 4" Screwdriver	Plastic Hang Tab/Label	72	6
27030	4" Scratch Awl	Plastic Hang Tab/Label	72	6
27031	4" Tack Puller	Plastic Hang Tab/Label	72	6

40 Screwdrivers



4-pc. Mini Screwdriver Set

- Sandblasted Chrome Vanadium Steel
- Precision-Machined Tips for Exact Fit
- 6-Flute Handles for Fingertip Control
- Compact Size Small Jobs or Tight Work Areas

- 1-pc. Flat: 3/16"
- 1-pc. Phillips: #1
- 1-pc. Flat: 1/4"
- 1-pc. Phillips: #2

Item	Description	Packaging	Cs	In
28071	4-pc. Mini Screwdriver Set	Slide Blister Card	288	12



6-pc. Long Precision Screwdriver Set

- Hardened and Tempered Carbon Steel Shafts
- Durable Chrome Plated Finish
- Knurled Nylon Handles for Fingertip Control
- Free-Turning End Caps Allow Constant Finger Pressure while Driving

- 1-pc. Flat: 2mm x 3"
- 1-pc. Phillips: #00 x 3"
- 1-pc. Flat: 3mm x 4"
- 1-pc. Phillips: #0 x 4"
- 1-pc. Flat: 4mm x 6"
- 1-pc. Phillips: #1 x 6"

Item	Description	Packaging	Cs	In
2974	6-pc. Long Precision Screwdriver Set	Slide Blister Card	120	12



6-pc. Precision Screwdriver Set

- Hardened Chrome Vanadium Steel
- Non-Slip Soft Grip Handles for Precise Control
- Free-Turning End Cap Allows Constant Finger Pressure While Turning
- Magnetized Tips

- Flat: 1.5mm x 50mm, 2mm x 50mm, 3mm x 50mm
- Phillips: #00 x 50mm, #0 x 50mm, #1 x 50mm
- Snap-in Organizer Case

Item	Description	Packaging	Cs	In
2976	6-pc. Precision Screwdriver Set	Sealed Blister	50	10

2972



2977

Precision Screwdriver Sets

- High-Strength, Heat Treated Chrome Vanadium Steel Shafts
- Corrosion-Resistant Chrome Plated Finish
- Comfortable Handles with Non-Slip Rubber Grips
- Swivel End Cap Allows Constant Finger Pressure while Driving
- Magnetized Tips Prevent Dropped Fasteners
- Meets or Exceeds ANSI Standards

2972

- 1-pc. Flat: 2.5 mm
- 1-pc. Phillips: #00

2977

- 3-pc. Flat: 1.5mm, 2.0mm, 2.5mm
- 3-pc. Phillips: #000, #00, #0
- 3-pc. Star: SD-5, SD-6, SD-7

Item	Description	Packaging	Cs	In
2972	2-pc. Precision Screwdriver Set	Slide Blister Card	144	12
2977	9-pc. Precision Screwdriver Set	Sealed Blister	72	12

2985



2987

Precision Screwdriver Sets

- Hardened Carbon Steel Shafts with Black Oxide Finish
- Chrome Plated Alloy Steel Handles with Non-Slip Knurled Grips
- Free-Turning End Cap Allows Constant Finger Pressure while Driving

2985

- 4-pc. Flat: 1.4mm, 2.0mm, 2.4mm, 3.0mm
- 2-pc. Phillips: #0-1, #1-2
- Complete with Organizer Case

2987

- 6-pc. Flat: 1, 1.4, 2, 2.4, 3, 3.8mm
- 4-pc. Phillips: #0-2, #0, #1-2, #1-1
- 3-pc. Hex: 1.5, 2, 2.5mm
- 3-pc. Nut Drivers: 3, 4, 5mm
- Complete with Organizer Case

Item	Description	Packaging	Cs	In
2985	6-pc. Precision Screwdriver Set	Slide Blister Card	96	12
2987	16-pc. Precision Screwdriver Set	Slide Blister Card	40	10

7-pc. Impact Screwdriver Sets

- Professional-Grade Impact Screwdriver with Non-Slip, Knurled Handle Grip
- Forward and Reverse Drive
- Corrosion-Resistant Chrome Plated Finish
- Hardened Chrome Vanadium Steel Bits
- Precision-Milled Tips for Exact Fit
- Loosens Rusted or Over-Tightened Screws

2905 • 1-pc. Impact Driver • 4-pc. Screwdriver Bits: Flat: 5/16", 3/8" Phillips: #2, #3 • 1-pc. 3/8" Drive Bit Chuck • 1-pc. Metal Storage Case	2910 • 1-pc. Impact Driver • 4-pc. Screwdriver Bits: Flat: 5/16", 3/8" Phillips: #2, #3 • 1-pc. 1/2" Drive Bit Chuck • 1-pc. Metal Storage Case
--	--



Item	Description	Packaging	Cs	In
2905	7-pc. 3/8" Drive Impact Screwdriver Set	Color Box	20	1
2910	7-pc. 1/2" Drive Impact Screwdriver Set	Color Box	20	1

8-pc. Impact Screwdriver Bit Set

- Hardened Chrome Vanadium Steel Bits
 - Corrosion-Resistant Sandblasted Finish
 - Precision-Milled Tips for Exact Fit
 - Universal Fit 3/8" Hex Shanks
- 4-pc. Screwdriver Bits (1-7/16"): Flat: 5/16", 3/8"; Phillips Bits: #2, #3
- 4-pc. Screwdriver Bits (3-3/16"): Flat: 5/16", 3/8"; Phillips Bits: #2, #3



Item	Description	Packaging	Cs	In
2915	8-pc. Impact Screwdriver Bit Set	Blister Card	72	12

10-in-1 Screwdriver Set

- Sandblasted Chrome Vanadium Steel Bits
 - Precision-Machined Bits for Exact Fit
 - Chrome Plated Steel Shaft with Magnetic Bit Holder
 - Comfortable Non-Slip Soft Handle Grip
 - On-board Bit Storage in Handle Compartment
- 2-pc. Flat Double-End Bits (2"): 1/8" x 5/32", 3/16" x 1/4"
- 2-pc. Phillips Double-End Bits (2"): #0 x #1, #2 x #3
- 1-pc. Star Drive Double-End Bit (2"): SD-15 x SD-20
- 1-pc. Bit Screwdriver



Item	Description	Packaging	Cs	In
2791	10-in-1 Screwdriver Set	Sealed Blister	100	5

22-pc. Flex Head Ratchet Screwdriver Set

- Flex Head Screwdriver Locks at Five Drive Angles
 - Three-Function Ratchet Drive: Forward, Fixed and Reverse
 - Rugged Steel Magnetic Bit Holder
 - Comfortable Non-Slip Soft Handle Grip
 - Sandblasted Chrome Vanadium Steel Bits
- 1-pc. Flex Head Ratchet Screwdriver
- 3-pc. Flat Bits (1"): 5/32", 3/16", 1/4"
- 3-pc. Phillips Bits (1"): #0, #1, #2
- 6-pc. Star Drive Bits (1"): SD-10, 15, 20, 25, 27, 30
- 3-pc. Square Bits (1"): S-1, S-2, S-3
- 3-pc. Clutch Bits (1"): 5/32", 3/16", 1/4"
- 3-pc. Bit Organizers



Item	Description	Packaging	Cs	In
2825	22-pc. Flex Head Ratchet Screwdriver Set	Slide Blister Card	48	6

42 Screwdrivers - Bit Type



2-pc. 6-in-1 and 4-in-1 Screwdriver Set

6-in-1 Screwdriver

- Tough Chrome Vanadium Steel Bits with Sandblasted Finish
- Comfortable HexTorque Handle with Non-Slip Rubber Grips
- Corrosion-Resistant Chrome Plated Steel Bit Tube

4-in-1 Pocket Screwdriver

- Pen-Style Design with Pocket Clip
- Durable and Lightweight Polymer Construction

- 1-pc. 6-in-1 Screwdriver
Flat: 3/16" and 1/4"
Phillips: #1 and #2
Nut Drivers: 1/4" and 5/16"
- 1-pc. 4-in-1 Pocket Screwdriver
Flat: 3, 4mm
Phillips: #0, #1

Item	Description	Packaging	Cs	In
2795	2-pc. 6-in-1 and 4-in-1 Screwdriver Set	Sealed Blister	72	12



2797

- AVAILABLE IN DISPLAY QUANTITIES ONLY

2796



6-in-1 Screwdrivers

- Tough Chrome Vanadium Steel Bits with Sandblasted Finish
- Comfortable HexTorque Handle with Non-Slip Rubber Grips
- Corrosion-Resistant Chrome Plated Steel Bit Tube

- Six Screwdrivers in One
Flat: 3/16" and 1/4"
Phillips: #1 and #2
Nut Drivers: 1/4" and 5/16"

Item	Description	Packaging	Cs	In
2796	6-in-1 Screwdriver	Sealed Blister	64	4
2797	6-in-1 Screwdriver	UPC Label/Display Box	120	12

- AVAILABLE IN DISPLAY QUANTITIES ONLY



6-in-1 Screwdriver

- Precision-Machined Sandblasted Chrome Vanadium Steel Bits
- Comfortable Oversized Mechanic's-Style Handle for Sure Grip
- Rugged Steel Bit Holder Shaft with Corrosion-Resistant Chrome Plated Finish
- Spring-Loaded Ball Bearings Lock Bits and Shaft in Place

- Six Drivers in One!
Flat: 3/16" and 1/4"
Phillips: #1 and #2
Nut Drivers: 1/4" and 5/16"

Item	Description	Packaging	Cs	In
2799	6-in-1 Screwdriver	UPC Label/Display Box	120	12



• AVAILABLE IN DISPLAY QUANTITIES ONLY

2-in-1 Pocket Screwdriver

- 4-1/2" Double-End Chrome Vanadium Steel Bit: 3/16" Flat x #1 Phillips
- Precision-Machined Magnetized Tips
- Compact Size with Pocket Clip

Item	Description	Packaging	Cs	In
28031	2-in-1 Pocket Screwdriver	UPC Label/Fishbowl	288	72



• AVAILABLE IN DISPLAY QUANTITIES ONLY

Pocket 4-in-1 Precision Screwdriver

- Heat Treated Carbon Steel Bits with Corrosion-Resistant Chrome Plated Finish
- Pen-Style Housing with Pocket Clip
- Use for Electronics, Hobbies, and Eyeglasses Repairs
- Four Drivers in One: 1/8" Flat x #0 Phillips, 1/16" Flat x #00 Phillips

Item	Description	Packaging	Cs	In
28111	Pocket 4-in-1 Precision Screwdriver	UPC Label/Display Box	432	72



22-pc. T-Handle Socket Screwdriver Set

- Sandblasted, Chrome Vanadium Steel Bits
- Heat Treated, Chrome Plated 6-Point Sockets
- High-Torque T-Handle Driver
- Chrome Plated Carbon Steel Shaft
- Bit Storage in Handle
- 9-pc. 1/4" Drive 6-Point Sockets (SAE): 3/16", 7/32", 1/4", 5/16", 11/32", 3/8", 7/16", 15/32", 1/2"
- 5-pc. Flat Bits (1"): 1/8", 5/32", 3/16", 1/4", 9/32"
- 3-pc. Phillips Bits (1"): #1, #2, #3
- 3-pc. Star Drive Bits (1"): SD-15, SD-20, SD-30
- 1-pc. 1/4" Hex x 1/4" Dr. Socket Adapter
- 1-pc. T-Handle Driver
- Complete with Bit and Socket Organizers

Item	Description	Packaging	Cs	In
2822	22-pc. T-Handle Socket Screwdriver Set	Sealed Blister	48	6

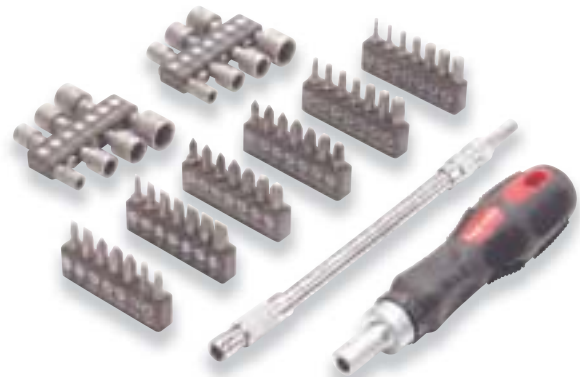

58-pc. Ratchet Driver and Bit Set

- Sandblasted Chrome Vanadium Steel Bits
- Ratchet Driver with Soft Non-Slip Handle Grip
- Forward, Fixed, and Reverse Drive Functions
- Chrome Plated Flex Extension
- 42-pc. 1" Screwdriver Bits:
Flat: 3mm, 4mm (2-pc.), 5mm (3-pc.), 6mm (2-pc.), 7mm
Star: SD-10, SD-15 (2-pc.), SD-20 (2-pc.), SD-25, SD-27, SD-30, SD-40
Hex: 2mm, 2.5mm, 3mm, 4mm, 5mm, 5.5mm, 6mm
Phillips: #0, #1 (3-pc.), #2 (4-pc.), #3 (2-pc.)
Pozi: PZ0, PZ1 (2-pc.), PZ2 (2-pc.), PZ3 (2-pc.)
- 7-pc. Nut Driver (SAE): 3/16", 1/4", 9/32", 11/32", 5/16", 3/8", 7/16"
- 7-pc. Nut Drivers (MM): 5, 6, 7, 8, 9, 10, 11mm
- 1-pc. 8" Flexible Extension
- 1-pc. Ratchet Driver Handle
- Complete with 8 Bit Organizers

Item	Description	Packaging	Cs	In
2837	58-pc. Ratchet Driver and Bit Set	Sealed Blister	24	6



30-pc. Compact Screwdriver and Bit Set

- Heat Treated, Sandblasted, Chrome Vanadium Steel Bits
- Precision-Machined Tips
- Chrome Plated Shaft
- Strong Magnetic Bit Holder
- Contoured Fluted Handle for Sure Grip
- Convenient, Compact Snap-in Organizer Case for Easy Storage

- 5-pc. Flat Bits (1"): 1/8", 5/32", 3/16", 1/4", 9/32"
- 4-pc. Phillips Bits (1"): #0, #1, #2, #3
- 6-pc. Star Drive Bits (1"): SD-10, 15, 20, 25, 30, 40
- 4-pc. Square Bits (1"): S-0, S-1, S-2, S-3
- 5-pc. Hex Bits (1"): 5/64", 3/32", 7/64", 1/8", 9/64"
- 2-pc. Pozi Bits (1"): PZ-1, PZ-2
- 1-pc. 1/4" Hex x 1/4" Dr. Socket Adapter
- 1-pc. 1/4" Dr. x 1/4" Hex Socket/Bit Adapter
- 1-pc. Pro Driver Handle
- 1-pc. Snap-In Organizer Case

Item	Description	Packaging	Cs	In
2842	30-pc. Compact Screwdriver and Bit Set	Color Label	48	6

105-pc. Everybit™ Ratchet Screwdriver and Bit Set

- Every Bit for Any Project
- Twelve Bit Types, Each in a Full Range of Sizes

Screwdriver Bits:

- Chrome Vanadium, Chrome Molybdenum and S2 Steel Construction
- Corrosion-Resistant Sandblasted Finish
- Use Bits with any Power Driver

Ratchet Screwdriver:

- 3-Function Ratchet Screwdriver: Forward, Fixed, and Reverse Drive
- Comfortable, Oversized Quadra-Torque™ Handle Generates Extra Torque

- 10-pc. Flat Bits (1"): 3/32", 7/64", 1/8", 9/64", 5/32", 3/16", 7/32", 1/4", 9/32", 5/16"
- 6-pc. Phillips Bits (1"): #0, #1, #2, #3, #4; Dry: #2
- 5-pc. Square Bits (1"): S-0, S-1, S-2, S-3, S-4
- 16-pc. Star Drive Bits (1"): SD-5, 5.5, 6, 7, 8, 9, 10, 15, 20, 25, 27, 30, 35, 40, 45, 50
- 5-pc. Pozi Bits (1"): PZ-0, PZ-1, PZ-2, PZ-3, PZ-4
- 12-pc. Hex Bits (1"): (SAE) 1/16", 5/64", 3/32", 7/64", 1/8", 9/64", 5/32", 3/16", 7/32", 1/4", 9/32", 5/16"
- 10-pc. Hex Bits (1"): (Metric) 1.5, 2, 2.5, 3, 4, 5, 5.5, 6, 7, 8
- 5-pc. Clutch Bits (1"): 1/8", 5/32", 3/16", 1/4", 7/32"
- 9-pc. Tamper Star Drive Bits (1"): SD-8, 10, 15, 20, 25, 27, 30, 35, 40
- 6-pc. Tamper Hex Bits (1"): (SAE) 5/32", 9/64", 1/8", 7/64", 3/32", 5/64"
- 6-pc. Tamper Hex Bits (1"): (Metric) 2, 2.5, 3, 4, 5, 6
- 4-pc. Tri-Wing Bits (1"): 1, 2, 3, 4
- 4-pc. Spanner Bits (1"): 4, 6, 8, 10mm
- 3-pc. Torq Bits (1"): 6, 8, 10mm
- 1-pc. 2-5/16" Magnetic Extension Bit Holder
- 1-pc. 1/4" Hex X 1/4" Dr. Socket Adapter
- 1-pc. Quadra-Torque™ Ratchet Handle
- 1-pc. Organizer Carry Case

Item	Description	Packaging	Cs	In
2840	105-pc. Everybit™ Ratchet Screwdriver and Bit Set	Sealed Blister	12	6



55-pc. Ratchet Screwdriver, Bit and Socket Set

- Sandblasted Chrome Vanadium Steel Bits
- Drop Forged Chrome Plated 6-Point Sockets
- 3-Function Ratchet Screwdriver: Forward, Fixed and Reverse Drive Positions
- Comfortable Oversized Screwdriver Handle
- Bits and Accessories Fit All Power and Cordless Drills and Drivers
- 1-pc. Ratchet Screwdriver
- 4-pc. Flat Bits (2"): 5/32", 3/16", 1/4", 9/32"
- 5-pc. Phillips Bits (2"): #0, #1, #2, #3 Dry: #2
- 3-pc. Square Bits (2"): S-1, S-2, S-3
- 5-pc. Hex Bits (1"): (SAE) 1/8", 5/32", 3/16", 7/32", 1/4"
- 5-pc. Hex Bits (1"): (Metric) 2, 3, 4, 5, 6
- 6-pc. Star Drive Bits (1"): SD-10, 15, 20, 25, 27, 30
- 1-pc. Bit Organizer
- 9-pc. 1/4" Dr. Sockets (SAE): 3/16", 7/32", 1/4", 5/16", 11/32", 3/8", 7/16", 15/32", 1/2"
- 9-pc. 1/4" Dr. Sockets (Metric): 5, 6, 7, 8, 9, 10, 11, 12, 13
- 2-pc. Socket Organizers
- 1-pc. 2-5/16" Magnetic Bit Holder
- 1-pc. 1/4" Hex x 1/4" Dr. Socket Adapter (2")
- 2-pc. Precision Screwdrivers: 2mm Flat, #00 Phillips
- 1-pc. Storage Case



Item	Description	Packaging	Cs	In
2846	55-pc. Ratchet Screwdriver, Bit and Socket Set	Sealed Blister	12	1



20-pc. Quick-Change Power Drill Bit Set

- All-in-One Power Drilling System Includes One-Touch, Quick-Change Bit Chuck
- Carbide-Tipped Steel Masonry Drill Bits Power Through Concrete, Brick and Block
- Industrial High Speed Steel Drill Bits Penetrate Metal, Wood, Plastic and Fiberglass
- High-Carbon Steel Spade Bits Cut Quickly and Cleanly Through Wood
- 1-pc. Quick Change Bit Chuck
- 10-pc. HSS Drill Bits (1/4" Hex Shank): 1/16, 5/64, 3/32, 7/64, 1/8, 9/64, 5/32, 3/16, 7/32, 1/4"
- 5-pc. Spade Drill Bits (1/4" Hex Shank): 3/8, 1/2, 5/8, 3/4, 7/8"
- 3-pc. Masonry Drill Bits (1/4" Hex Shank): 1/8, 3/16, 1/4"
- 1-pc. Snap-In Organizer Case

Item	Description	Packaging	Cs	In
29431	20-pc. Quick-Change Power Drill Bit Set	Sealed Blister	12	1

15-pc. 1/2" Drive Star Bit Set

- Drop Forged, Heat Treated Chrome Vanadium Steel
- Corrosion-Resistant Sandblasted Finish
- Precision-Machined Tips for Exact Fit
- 7-pc. 3/8" Hex Star Bits (1-1/4") : SD-20, SD-25, SD-30, SD-40, SD-45, SD-50, SD-55
- 7-pc. 3/8" Hex Star Bits (3") : SD-20, SD-25, SD-30, SD-40, SD-45, SD-50, SD-55
- 1-pc. 1/2" Drive Bit Adapter Socket
- Complete with Storage Case

Item	Description	Packaging	Cs	In
4918	15-pc. 1/2" Drive Star Bit Set	Sealed Blister	24	1

42-pc. Quick-Change Power Driver Bit Set

- All-in-One Power Driver System Includes One-Touch, Quick-Change Bit Chuck
- Hardened, Chrome Vanadium Steel Bits with Corrosion-Resistant, Sandblasted Finish
- 1-pc. Quick-Change Bit Chuck
- 1-pc. Retracting Screw Holder/Driver
- 1-pc. 4" Extension Bit Holder
- 1-pc. 1/4" Hex x 3/8" Dr. Power Socket Adapter
- 7-pc. Power Nut Drivers (SAE): 3/16", 1/4", 9/32", 5/16", 11/32", 3/8", 7/16"
- 2-pc. Flat Bits (1"): 3/16", 1/4"
- 3-pc. Phillips Bits (1"): #1, #2 (2)
- 2-pc. Drywall Bits (1"): #2 (2)
- 5-pc. Star Drive Bits (1"): SD-10, 15, 20, 25, 30
- 7-pc. Flat Bits (2"): 1/8", 5/32", 3/16" (2), 1/4" (2), 9/32"
- 5-pc. Phillips Bits (2"): #0, #1, #2 (2), #3
- 2-pc. Drywall Bits (2"): #2 (2)
- 4-pc. Square Bits (2"): S-1, S-2 (2), S-3
- 1-pc. Tri-Fold Organizer Case

Item	Description	Packaging	Cs	In
29432	42-pc. Quick-Change Power Driver Bit Set	Sealed Blister	12	1



46 Screwdrivers - Bit Type



Magnetic Bit Holders

- Chrome Plated Alloy Steel Tube
- Universal Fit 1/4" Chrome Vanadium Steel Hex Shank
- Strong Magnet Retains Bit in Place
- Accepts any 1/4" Hex Shank Driver Bit

2887
 • MINIMUM ORDER QUANTITY:
 10-PC. POLYBAG

Item	Description	Packaging	Cs	In
2869	2-1/2" Magnetic Bit Holder	Slide Blister Card	288	12
2887	2-1/2" Magnetic Bit Holder	Poly Bag/No Label	1000	10
2901	6" Magnetic Bit Holder	Slide Blister Card	288	12



Power Extension Bars

- Sandblasted Chrome Vanadium Steel
- Spring-Loaded Ball Bearing Locks onto Sockets
- Adapts any Power Drill to Drive Sockets

2902
 • 1-pc. 1/4" Hex x 1/4" Dr.
 • 1-pc. 1/4" Hex x 3/8" Dr.
 • 1-pc. 1/4" Hex x 1/2" Dr.

2903 / 2904
 • MINIMUM ORDER QUANTITY:
 10-PC. POLYBAG

Item	Description	Packaging	Cs	In
2902	3-pc. Power Socket Adapter Set	Slide Blister Card	72	12
2903	1/4" Hex x 1/4" Drive Power Socket Adapter	Poly Bag/No Label	1000	10
2904	1/4" Hex x 3/8" Drive Power Socket Adapter	Poly Bag/No Label	1000	10



25-pc. 1" Power Bits (#2 Phillips)

- Hardened Nickel Chrome Molybdenum Steel
- Sandblasted Finish Resists Corrosion
- Precision-Milled Tip for Exact Fit
- Universal Fit 1/4" Hex Shank

• 25-pc. Phillips Bits (1"): #2

Item	Description	Packaging	Cs	In
82545	25-pc. 1" Power Bits (#2 Phillips)	Blister Card	72	6



8" Flex Extension Bit Holder

- Flexible Heat Treated Spring Steel Shaft
- Durable Corrosion-Resistant Enamel Finish
- Retainer Collar Locks Bit in Place
- Universal Fit for all 1/4" Hex Shank Screwdriver Bits
- Designed for Use with Power Drills and Drivers
- Replacement Retainer Collar Kit Included

Item	Description	Packaging	Cs	In
2900	8" Flex Extension Bit Holder	Slide Blister Card	144	12

Retracting Screw Holder/Driver

- Retractable Sleeve Guides Screw for a Straight Drive Every Time
- Magnetized Tip Holds Screw in Position for Accurate Start
- Allows One Hand Driving - Frees Second Hand for Positioning Work Pieces
- Prevents Screw Wandering in Tough Wood Grain and Near other Holes
- Screw Capacity: 2-1/2" Length
- Sandblasted Chrome Vanadium Steel Bits

- 1-pc. Retracting Screw Holder/Driver
- 2-pc. Flat Bits (1"): 3/16", 1/4"
- 2-pc. Phillips Bits (1"): #1, #2
- 1-pc. Drywall Bit (1"): #2
- 1-pc. Bit Holder

Item	Description	Packaging	Cs	In
2899	Retracting Screw Holder/Driver	Slide Blister Card	144	12

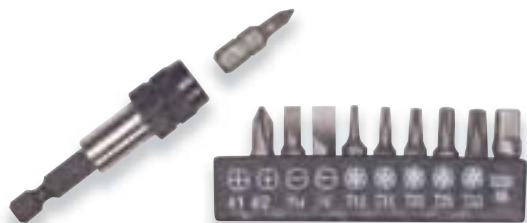

11-pc. Bit and Driver Set

- Sandblasted S2 Steel Screwdriver Bits
- Knurled Locking Collar with Anodized Finish
- Stainless Steel Magnetic Bit Holder
- 1-pc. 2-3/8" Quick Release Bit Holder
- 9-pc. 1" Screwdriver Bits: Flat: 3/16", 1/4"; Phillips: #1, #2; Star Drive: SD-10, 15, 20, 25, 30
- 1-pc. 1" Socket Adapter

Item	Description	Packaging	Cs	In
2909	11-pc. Bit and Driver Set	Sealed Blister	144	24



2870



2883



6-pc. 1" Star Bit Sets

- Sandblasted Chrome Vanadium Steel
- Precision-Milled Tips for Exact Fit
- Universal Fit 1/4" Hex Shank

2870

- 6-pc. Star Drive Bits (1"):
SD-10, 15, 20, 25, 27, 30
- Complete with Bit Organizer

2883

- 6-pc. Star Drive Bits (1"):
SD-5, 5.5, 6, 7, 8, 9
- Complete with Bit Organizer

Item	Description	Packaging	Cs	In
2870	6-pc. 1" Star Drive Bit Set	Slide Blister Card	250	50
2883	6-pc. 1" Mini Star Bit Set	Slide Blister Card	250	10

7-pc. 1" Security Star Bit Set

- Sandblasted S-2 Steel
- Precision-Milled Tips for Exact Fit
- Universal Fit 1/4" Hex Shank
- Security Bits Fit Tamper-Resistant Star Drive Fasteners

- 7-pc. Tamper Star Bits (1"):
SD-10, 15, 20, 25, 27, 30, 40
- Complete with Bit Organizer

Item	Description	Packaging	Cs	In
2886	7-pc. 1" Security Star Bit Set	Slide Blister Card	250	50

10-pc. Power Bit Sets

- Nickel Chrome Molybdenum Steel Construction
- Durable Sandblasted Finish
- Precision-Milled for Exact Fit
- Universal 1/4" Hex Shank

- 4-pc. Flat: 5/32", 3/16", 1/4", 9/32"
- 4-pc. Phillips: #0, #1, #2, #3
- 2-pc. Star Drive: SD-15, SD-20
- Complete with Workbelt Storage Clip

2912



2913



Item	Description	Packaging	Cs	In
2912	10-pc. 2" Power Bit Set	Slide Blister Card	72	12
2913	10-pc. 2-1/2" Double-End Power Bit Set	Slide Blister Card	72	12

33-pc. Security Screwdriver Bit Set

- Sandblasted Chrome Vanadium Steel
- Precision-Milled Tips for Exact Fit
- Universal Fit 1/4" Hex Shank
- Security Bits Fit Five Common Styles of Tamper-Resistant Fasteners

- 32-pc. 1" Security Screwdriver Bits:
Star: SD-8, SD-10, SD-15, SD-20, SD-25, SD-27, SD-30, SD-35, SD-40
Hex Bits (SAE): 5/32, 9/64, 1/8, 7/64, 3/32, 5/64"
Hex Bits (Metric): 2, 2.5, 3, 4, 5, 6mm
Torque: 6, 8, 10mm
Spanner: 4, 6, 8, 10mm
Tri-Wing: #1, #2, #3, #4
- 1-pc. 2-1/2" Magnetic Extension Bit Holder
- Complete with Bit Organizer

Item	Description	Packaging	Cs	In
2930	33-pc. Security Screwdriver Bit Set	Slide Blister Card	72	12

33-pc. Screwdriver Bit Set

- Sandblasted Chrome Vanadium Steel
- Precision-Milled Tips for Exact Fit
- Universal Fit 1/4" Hex Shank
- Features the Most Common Sizes in One Compact Set

- 32-pc. 1" Screwdriver Bits:
Flat: 1/8, 5/32, 3/16, 1/4, 9/32"
Phillips: #0, 1, 2 (3-pc.), #3
Drywall: #2 (2-pc.)
Star: SD-10, SD-15, SD-20, SD-25, SD-27, SD-30, SD-40
Hex: 3/32, 5/64, 7/64, 1/8, 9/64, 5/32, 3/16, 1/4"
Square: S-0, S-1, S-2, S-3
- 1-pc. 2-5/16" Magnetic Bit Holder
- Complete with Bit Organizer

Item	Description	Packaging	Cs	In
82157	33-pc. Screwdriver Bit Set	Slide Blister Card	72	6

48 Screwdrivers - Bit Type

Power Nut Driver Bit Sets

- Forged and Hardened Chrome Vanadium Steel
- Corrosion-Resistant Sandblasted Finish
- Universal Fit 1/4" Hex Shank

2928

- 7-pc. Power Nut Driver Bits (SAE): 3/16", 1/4", 9/32", 5/16", 11/32", 3/8", 7/16"
- 7-pc. Power Nut Driver Bits (Metric): 5, 5.5, 6, 7, 8, 10, 12mm
- Complete with Workbelt Storage Clip

2935

- 7-pc. Power Nut Driver Bits (SAE): 3/16", 1/4", 9/32", 5/16", 11/32", 3/8", 7/16"
- Complete with Workbelt Storage Clip

Item	Description	Packaging	Cs	In
2928	14-pc. Power Nut Driver Bit Set	Slide Blister Card	72	12
2935	7-pc. Power Nut Driver Bit Set	Slide Blister Card	72	12

Power Nut Driver Bit Sets

- Forged and Hardened Chrome Vanadium Steel
- Corrosion-Resistant Sandblasted Finish
- Universal 1/4" Hex Shanks fit Quick-Change Chucks and any Drill, Driver, or Screwgun

- 7-pc. Power Nut Driver Bits (SAE): 3/16", 1/4", 9/32", 5/16", 11/32", 3/8", 7/16"
- 7-pc. Power Nut Driver Bits (Metric): 5, 5.5, 6, 7, 8, 10, 12mm
- Complete with Workbelt Storage Clip

Item	Description	Packaging	Cs	In
2938	14-pc. Power Nut Driver Bit Set (SAE / Metric)	Slide Blister Card	72	12

Magnetic Nut Drivers

- Sandblasted Chrome Vanadium Steel
- Magnet Retains Fastener in Place for Easy Starting
- Universal Fit 1/4" Hex Shank

- MINIMUM ORDER QUANTITY: 10-PC. POLYBAG

Item	Description	Packaging	Cs	In
2895	7/16" x 2-9/16" Magnetic Nut Driver	Poly Bag/No Label	500	10
2896	1/4" x 2-9/16" Magnetic Nut Driver	Poly Bag/No Label	500	10
2897	5/16" x 2-9/16" Magnetic Nut Driver	Poly Bag/No Label	500	10
2898	3/8" x 2-9/16" Magnetic Nut Driver	Poly Bag/No Label	500	10

3-pc. Magnetic Nut Driver Bit Set

- Sandblasted Chrome Vanadium Steel
- Magnet Holds Fastener for Easy Starting
- Universal Fit 1/4" Hex Shank
- 2-9/16" Overall Length

Item	Description	Packaging	Cs	In
2906	3-pc. Magnetic Nut Driver Bit Set	Slide Blister Card	144	12



- Sandblasted Chrome Vanadium Steel
- Precision Milled Bits
- 1/4" Hex Drive

• MINIMUM ORDER QUANTITY: 10-PC. POLYBAG

1" (25mm) BITS

Item	Description	Packaging	Cs	In
2850	#1 Square x 1" (25mm) Bit	Poly Bag/No Label	1000	10
2851	#2 Square x 1" (25mm) Bit	Poly Bag/No Label	1000	10
2852	#3 Square x 1" (25mm) Bit	Poly Bag/No Label	1000	10
2854	SD-20 x 1" (25mm) Star Drive Bit	Poly Bag/No Label	1000	10
2855	3/16" Flat x 1" (25mm) Bit	Poly Bag/No Label	1000	10
2856	1/4" Flat x 1" (25mm) Bit	Poly Bag/No Label	1000	10
2857	#0 Phillips x 1" (25mm) Bit	Poly Bag/No Label	1000	10
2858	#1 Phillips x 1" (25mm) Bit	Poly Bag/No Label	1000	10
2859	#3 Phillips x 1" (25mm) Bit	Poly Bag/No Label	1000	10
2878	#2 Drywall x 1" (25mm) Bit	Poly Bag/No Label	1000	10
2921	#2 Phillips x 1" (25mm) Bit	Poly Bag/No Label	1000	10

2" (50mm) BITS

Item	Description	Packaging	Cs	In
2860	#1 Square x 2" (50mm) Bit	Poly Bag/No Label	1000	10
2861	#2 Square x 2" (50mm) Bit	Poly Bag/No Label	1000	10
2862	#3 Square x 2" (50mm) Bit	Poly Bag/No Label	1000	10
2863	3/16" Flat x 2" (50mm) Bit	Poly Bag/No Label	1000	10
2864	1/4" Flat x 2" (50mm) Bit	Poly Bag/No Label	1000	10
2865	#0 Phillips x 2" (50mm) Bit	Poly Bag/No Label	1000	10
2866	#1 Phillips x 2" (50mm) Bit	Poly Bag/No Label	1000	10
2867	#3 Phillips x 2" (50mm) Bit	Poly Bag/No Label	1000	10
2922	#2 Phillips x 2" (50mm) Bit	Poly Bag/No Label	1000	10

2-1/2" (65mm) DOUBLE-END BITS

Item	Description	Packaging	Cs	In
2868	#2 Square x 2-1/2" (65mm) Double-End Bit	Poly Bag/No Label	1000	10
2879	#2 Drywall x 2-1/2" (65mm) Double-End Bit	Poly Bag/No Label	1000	10
2923	#2 Phillips x 2-1/2" (65mm) Double-End Bit	Poly Bag/No Label	1000	10
2924	#2 Phillips x 1/4" Flat x 2-1/2" (65mm) Double-End Bit	Poly Bag/No Label	1000	10

6" (150mm) BITS

Item	Description	Packaging	Cs	In
2871	3/16" Flat x 6" (150mm) Bit	Poly Bag/No Label	500	10
2872	1/4" Flat x 6" (150mm) Bit	Poly Bag/No Label	500	10
2874	#1 Phillips x 6" (150mm) Bit	Poly Bag/No Label	500	10
2876	#2 Phillips x 6" (150mm) Bit	Poly Bag/No Label	500	10
2877	#3 Phillips x 6" (150mm) Bit	Poly Bag/No Label	500	10

1" (25mm) DIMPLE BIT

Item	Description	Packaging	Cs	In
2920	#2 Drywall Dimple Driver Bit	Poly Bag/No Label	1000	10

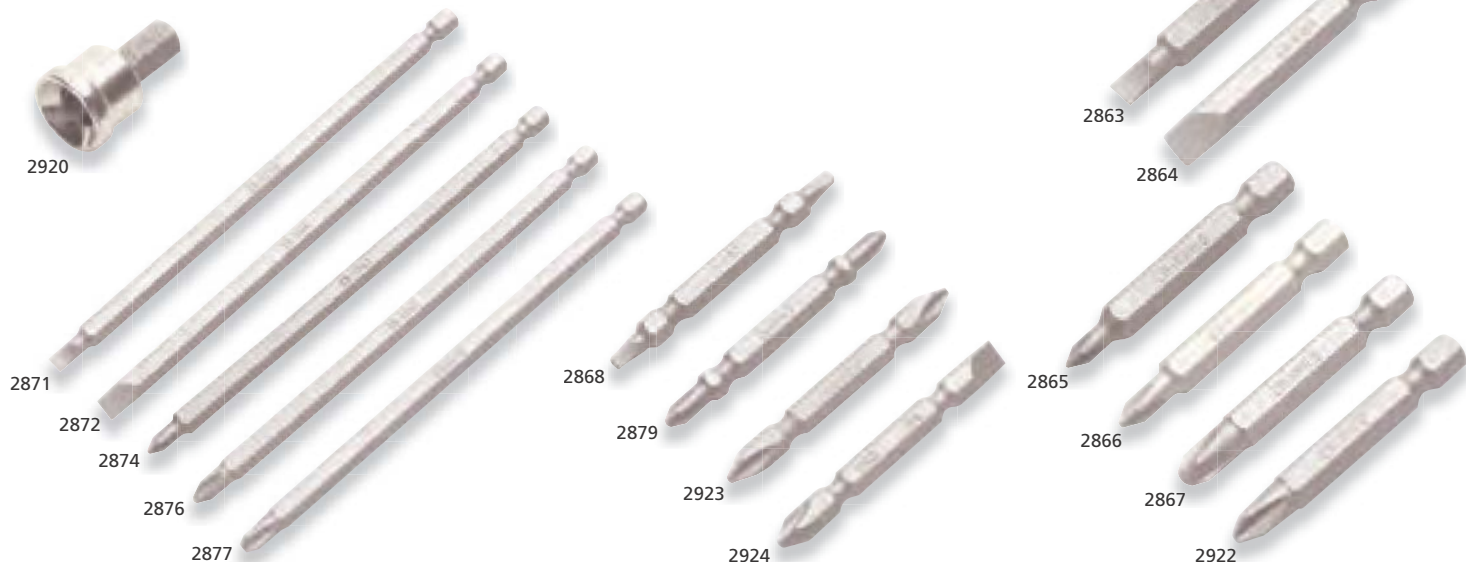



5 oz. Magnetic Tack Hammer

- Drop Forged, Heat Treated Steel Head
- Strong Magnetic Claw Holds Tacks and Nails
- Rugged Contoured Hardwood Handle
- Flat Face for Driving Tacks, Nails and Brads
- Steel Wedge Locks Head to Handle

Item	Description	Packaging	Cs	In
3010	5 oz. Magnetic Tack Hammer	Color Label	72	6



8 oz. Wood Claw Hammer

- Solid Cast Steel Head with Semi-Polished, Lacquer-Coated Finish
- Full Size Round Striking Face
- Beveled-End Curved Claw
- Contoured Hardwood Handle
- Epoxy Bond Locks Head to Handle

Item	Description	Packaging	Cs	In
3013	8 oz. Wood Claw Hammer	Color Label	60	6



16-oz. Wood Hammers

Claw

- Drop Forged, Heat Treated Steel Head with Polished, Lacquer-Coated Finish
- Full Size Round Striking Face
- Beveled-End Curved Claw
- Contoured Hardwood Handle
- Epoxy Bond Locks Head to Handle

Rip

- Drop Forged, Heat Treated Steel Head with Polished, Lacquer-Coated Finish
- Full Size Round Striking Face
- Beveled-End Straight Rip Claw
- Contoured Hardwood Handle
- Epoxy Bond Locks Head to Handle

Item	Description	Packaging	Cs	In
3020	16 oz. Wood Claw Hammer	Color Label	36	6
3030	16 oz. Wood Rip Hammer	Color Label	36	6



16 oz. Hickory Claw Hammer

- Drop Forged, Heat Treated Steel Head
- Full Size Round Face for Accurate Striking
- Fully Polished, Lacquer Coated Head
- Beveled-End Curved Claw
- Rugged American Hickory Handle
- Epoxy Bond Locks Head to Handle

Item	Description	Packaging	Cs	In
3028	16 oz. Hickory Claw Hammer	Color Label	36	6



8 oz. Tubular Steel Claw Hammer

- Solid Cast Steel Head with Semi-Polished, Lacquer-Coated Finish
- Full Size Round Striking Face
- Beveled-End Curved Claw
- Tubular Steel Handle with Cushioned Non-Slip Grip

Item	Description	Packaging	Cs	In
3016	8 oz. Tubular Steel Claw Hammer	Color Label	60	12

16 oz. Tubular Steel Claw Hammer

- Drop Forged, Heat Treated Steel Head with Polished, Lacquer-Coated Finish
- Full Size Round Striking Face
- Beveled-End Curved Claw
- Rugged Tubular Steel Handle with Non-Slip Rubber Grip



Item	Description	Packaging	Cs	In
3048	16 oz. Tubular Steel Claw Hammer	Color Label	36	6



16-oz. Fiberglass Hammers

- Claw**
- Drop Forged, Heat Treated Steel Head with Polished, Lacquer-Coated Finish
 - Full Size Round Striking Face
 - Beveled-End Curved Claw
 - Rugged 35% Fiberglass Handle with Non-Slip Rubber Grip
 - Epoxy Bond Locks Head to Handle

- Rip**
- Drop Forged, Heat Treated Steel Head with Polished, Lacquer-Coated Finish
 - Full Size Round Striking Face
 - Beveled-End Straight Rip Claw
 - Rugged 35% Fiberglass Handle with Non-Slip Rubber Grip
 - Epoxy Bond Locks Head to Handle

Item	Description	Packaging	Cs	In
3040	16 oz. Fiberglass Claw Hammer	Color Label	36	6
3045	16 oz. Fiberglass Rip Hammer	Color Label	36	6



16-oz. Fiberglass Hammers

- Claw**
- Drop Forged, Heat Treated Steel Head with Polished, Lacquer-Coated Finish
 - Full Size Round Striking Face
 - Beveled-End Curved Claw
 - Rugged 50% Fiberglass Handle with Non-Slip Rubber Grip
 - Epoxy Bond Locks Head to Handle

- Rip**
- Drop Forged, Heat Treated Steel Head with Polished, Lacquer-Coated Finish
 - Full Size Round Striking Face
 - Beveled-End Straight Rip Claw
 - Rugged 50% Fiberglass Handle with Non-Slip Rubber Grip
 - Epoxy Bond Locks Head to Handle

Item	Description	Packaging	Cs	In
3042	16 oz. Fiberglass Claw Hammer	Color Label	36	6
3044	16 oz. Fiberglass Rip Hammer	Color Label	36	6

Jacketed Fiberglass Claw and Rip Hammers

- Claw**
- Drop Forged, Heat Treated Steel Head with Polished, Lacquer-Coated Finish
 - Full Size Round Striking Face
 - Beveled-End Curved Claw
 - Jacketed Fiberglass Handle Protects Against Overstrikes
 - Cushioned Non-Slip Rubber Handle Grip
 - Meets or Exceeds ANSI Standards

- Rip**
- Drop Forged, Heat Treated Steel Head with Polished, Lacquer-Coated Finish
 - Full Size Round Striking Face
 - Beveled-End Straight Rip Claw
 - Jacketed Fiberglass Handle Protects Against Overstrikes
 - Cushioned Non-Slip Rubber Handle Grip
 - Meets or Exceeds ANSI Standards

Item	Description	Packaging	Cs	In
3055	16 oz. Jacketed Fiberglass Claw Hammer	Color Label	36	6
3056	16 oz. Jacketed Fiberglass Rip Hammer	Color Label	36	6
3057	20 oz. Jacketed Fiberglass Claw Hammer	Color Label	24	6
3058	20 oz. Jacketed Fiberglass Rip Hammer	Color Label	24	6
3059	24 oz. Jacketed Fiberglass Rip Hammer	Color Label	24	6





24 oz. Hickory Framing Hammer

- Drop Forged, Heat Treated Steel
- Rugged American Hickory Handle
- Mirror Polished, Lacquer Coated Head
- Precision-Milled Face Grips Nails
- Dual Steel Wedge System Locks Head to Handle
- Meets or Exceeds ANSI Standards

Item	Description	Packaging	Cs	In
3066	24 oz. Hickory Framing Hammer	Color Label	24	6



24 oz. Hardwood Framing Hammer

- Drop Forged, Heat Treated Steel Head with Fully Polished, Lacquer-Coated Head
- Milled Waffle Face for Non-Slip Strike
- Beveled-End Straight Claw
- Rugged Hardwood Handle
- Epoxy Bond Locks Head to Handle

Item	Description	Packaging	Cs	In
3069	24 oz. Hardwood Framing Hammer	Color Label	24	6



4-pc. Fiberglass Ball Pein Hammer Set

- Drop Forged, Heat Treated Steel Heads
- Durable Polished and Lacquer-Coated Finish
- Epoxy Bonded Fiberglass Handles
- Textured Non-Slip Rubber Handle Grips
- 1-pc. 8-oz.
- 1-pc. 12-oz.
- 1-pc. 16-oz.
- 1-pc. 24-oz.

Item	Description	Packaging	Cs	In
3080	4-pc. Fiberglass Ball Pein Hammer Set	Color Box	8	1

Fiberglass Ball Pein Hammers

- Drop Forged, Heat Treated Steel Head
- Precision-Machined Face and Pein
- Semi-Polished, Lacquer Coated Head
- Fiberglass Handle for Sure Strength
- Cushioned Textured Non-Slip Rubber Handle Grip
- Epoxy Bond Locks Head to Handle

Item	Description	Packaging	Cs	In
3081	8 oz. Fiberglass Ball Pein Hammer	Color Label	48	6
3082	12 oz. Fiberglass Ball Pein Hammer	Color Label	48	6
3083	16 oz. Fiberglass Ball Pein Hammer	Color Label	36	6
3084	24 oz. Fiberglass Ball Pein Hammer	Color Label	24	6
3086	32 oz. Fiberglass Ball Pein Hammer	Color Label	12	4
3087	48 oz. Fiberglass Ball Pein Hammer	Color Label	12	4





Drilling Hammers

3100

- Drop Forged, Heat Treated Steel Head
- Round, Polished Striking Surfaces
- Rugged Contoured Hardwood Handle
- Epoxy Bond Locks Head to Handle

3101

- Drop Forged, Heat Treated Steel Head
- Round, Polished Striking Surfaces
- Rugged Contoured Hardwood Handle
- Epoxy Bond Locks Head to Handle

3108

- Drop Forged, Heat Treated Steel Head
- Fully Polished Head
- Square, Polished Striking Faces
- Rugged 50% Fiberglass Handle
- Cushioned Textured Non-Slip Rubber Grip
- Epoxy Bond Locks Head to Handle

Item	Description	Packaging	Cs	In
3100	2 lb. Drilling Hammer	Color Label	24	6
3101	3 lb. Drilling Hammer	Color Label	12	4
3108	3 lb. Fiberglass Drilling Hammer	Color Label	16	4



Sledge Hammers

3103

- Drop Forged, Heat Treated Steel Head
- Round, Polished Striking Surfaces
- Rugged Contoured Hardwood Handle
- Epoxy Bond Locks Head to Handle

3104

- Drop Forged, Heat Treated Steel Head
- Round, Polished Striking Surfaces
- Rugged Contoured Hardwood Handle
- Epoxy Bond Locks Head to Handle

3110

- Drop Forged, Heat Treated Steel Head
- Fully Polished Head
- Square, Polished Striking Faces
- Rugged 50% Fiberglass Handle
- Cushioned Textured Non-Slip Rubber Grip
- Epoxy Bond Locks Head to Handle

Item	Description	Packaging	Cs	In
3103	3 lb. Sledge Hammer	Color Label	12	4
3104	4 lb. Sledge Hammer	Color Label	12	4
3110	3 lb. Fiberglass Sledge Hammer	Color Label	16	4

3 lb. Fiberglass Machinist Hammer

- Drop Forged, Heat Treated Steel Head
- Fully Polished Head
- Square and Tapered Striking Faces
- Rugged 50% Fiberglass Handle
- Cushioned Textured Non-Slip Rubber Grip
- Epoxy Bond Locks Head to Handle

Item	Description	Packaging	Cs	In
3112	3 lb. Fiberglass Machinist Hammer	Color Label	16	4



3-pc. Rubber Mallet Set

- Double-Faced Solid Rubber Heads
- Rugged Natural Hardwood Handles
- General-Purpose Non-Marring Mallets for Sheet Metal Fabrication, Automotive Repairs, and Construction Applications
- 1-pc. 8-oz. (1-3/4" Dia.)
- 1-pc. 16-oz. (2-1/4" Dia.)
- 1-pc. 32-oz. (2-5/8" Dia.)

Item	Description	Packaging	Cs	In
3161	3-pc. Rubber Mallet Set	Color Box	12	1

Rubber Mallets

- Double-Faced Solid Rubber Head
- Round Striking Surfaces
- Rugged Hardwood Handle

Item	Description	Packaging	Cs	In
3172	8 oz. Rubber Mallet	Color Label	36	4
3174	16 oz. Rubber Mallet	Color Label	36	6
3168	24 oz. Rubber Mallet	Color Label	24	4
3169	32 oz. Rubber Mallet	Color Label	16	4



54 Striking Tools



16 oz. White Rubber Mallet

- Double-Faced Solid Rubber Head
- 2-1/4" Round Striking Surfaces
- White Rubber will not Mark Surfaces
- Rugged Tubular Steel Handle
- Cushioned Textured Non-Slip Handle Grip

Item	Description	Packaging	Cs	In
3165	16 oz. White Rubber Mallet	Color Label	36	4



16 oz. Fiberglass Rubber Mallet

- Double-Faced Solid Rubber Head
- 2-1/4" Round Striking Surfaces
- Rugged Fiberglass Handle
- Cushioned Textured Non-Slip Handle Grip

Item	Description	Packaging	Cs	In
3166	16 oz. Fiberglass Rubber Mallet	Color Label	24	4



Double-Face Soft Mallets

3179

- Two 35mm Diameter Replaceable Heads: Black Rubber Head for a Cushioned Strike, High Impact Plastic Head For a Positive Strike
- Rugged Tubular Steel Handle
- Cushioned Non-Slip Rubber Handle Grip

3180

- Two 40mm Diameter Replaceable Heads: Black Rubber Head for a Cushioned Strike, High Impact Plastic Head For a Positive Strike
- Rugged Tubular Steel Handle
- Cushioned Non-Slip Rubber Handle Grip

Item	Description	Packaging	Cs	In
3179	Double-Faced Soft Mallet	Color Label	48	6
3180	Double-Faced Soft Mallet	Color Label	36	6



64 oz. Dead Blow Hammer

Deadblow Hammers

- Steel Shot-Filled Head Adds Extra Force to Hammer Blows and Eliminates Rebound
- Steel Handle Encased in High-Impact, Rubberized Plastic to Prevent Marring
- Diamond Textured Non-Slip Handle

Item	Description	Packaging	Cs	In
3182	16 oz. Dead Blow Hammer	Color Label	24	4
3183	24 oz. Dead Blow Hammer	Color Label	24	4
3184	32 oz. Dead Blow Hammer	Color Label	24	4
3188	48 oz. Dead Blow Hammer	Color Label	12	3
3189	64 oz. Dead Blow Hammer	Color Label	12	3



Fiberglass Brass Hammers

- Precision-Machined Solid Brass Head
- Non-Sparking Head will not Mar Finished Steel Surfaces
- Mirror-Polished, Lacquer-Coated Head
- Rugged 50% Fiberglass Jacketed Handle

Item	Description	Packaging	Cs	In
3190	16 oz. Fiberglass Brass Hammer	Color Label	24	4
3191	24 oz. Fiberglass Brass Hammer	Color Label	24	4
3192	32 oz. Fiberglass Brass Hammer	Color Label	16	4

8 oz. Chipping Hammer

- Drop Forged, Heat Treated Steel Head
- Full Solid Steel Shaft
- Shock-Dampening Spring Handle
- Double-End Head Features 7/8" Chisel End and Slag Remover End
- Specially Designed for Welding Applications



Item	Description	Packaging	Cs	In
3079	8 oz. Chipping Hammer	Color Label	36	6



3-Way Folding Shovel with Storage Pouch

- All Steel Unit from Handle to Shovel
- 9" x 6" Steel Blade
- Spade Tip for Easy Digging
- Blade has Serrated Edge and Side for Sawing Firewood, Etc.
- Shovel Collapses from 23" to 10" for Easy Storage
- Ideal for Camping or Keep in Vehicle for Emergency Snow Removal
- Includes a Convenient Canvas Carrying Bag

Item	Description	Packaging	Cs	In
7888	3-Way Folding Shovel with Storage Pouch	Color Label	12	1



Shingle Hatchet

- Drop Forged, Heat Treated Steel Head
- Square Precision-Milled Mesh Patterned Face
- Sharpened Hatchet End
- Mirror Polished, Lacquer Coated Head
- Rugged Solid American Hickory Handle
- Dual Steel Wedge System Locks Head to Handle
- Wrist Lanyard Prevents Dropping Tool

Item	Description	Packaging	Cs	In
3073	Shingle Hatchet	Color Label	24	2



Felling Axes

- Drop Forged, Heat Treated Steel Head
- Rugged Contoured Hardwood Handle
- Epoxy Wedge Locks Head to Handle

Item	Description	Packaging	Cs	In
3240	1-1/4 lb. Felling Axe	Color Label	24	6
3245	2 lb. Felling Axe	Color Label	24	6
3250	2-1/2 lb. Felling Axe	Color Label	12	6



Camp Axes

3280

- Drop Forged, Heat Treated Steel Head
- Fully Polished Head
- Rugged Tubular Steel Handle
- Cushioned Non-Slip Rubber Handle Grip
- 13" Overall Length

3283

- Drop Forged, Heat Treated Steel Head
- Fully Polished Head
- 50% Fiberglass Handle for Sure Strength
- Cushioned Non-Slip Rubber Handle Grip
- 13-1/4" Overall Length

Item	Description	Packaging	Cs	In
3280	20 oz. Tubular Handle Camp Axe	Color Label	36	6
3283	20 oz. Fiberglass Camp Axe	Color Label	24	6



Tack Puller

- Drop Forged, Heat Treated Carbon Steel Blade
- Contoured Square Handle for Sure Grip
- Angled "V" Slot Chisel Tip
- Pulls Stubborn Tacks, Brads and Staples
- 4" Blade Length, 7-1/2" Overall Length

Item	Description	Packaging	Cs	In
3304	Tack Puller	Slide Blister Card	100	10



Utility Pry Bars

- Rugged Hardened and Tempered Steel
- Durable, Baked Enamel Finish
- Three Nail Slots: One in Center, One at Each End
- Beveled, Sharpened Ends Slide into Tight Spots
- Flat End for Heavy Duty Prying
- Rocker Hook End for Extra Leverage and Use in Confined Areas

Item	Description	Packaging	Cs	In
3305	7-1/2" Utility Pry Bar	Color Label	240	12
3318	15" Utility Pry Bar	Color Label	36	6
3320	18" Utility Pry Bar	Color Label	36	6



11" Nail Claw

- Drop Forged Hardened Steel Construction
- Made from Solid Hex Bar Stock
- Non-Slip Cushioned Handle Grip
- 90° Angle Paw with Deep "V" Nail Slot

Item	Description	Packaging	Cs	In
3310	11" Nail Claw	Color Label	60	6



Wrecking Bars

- Drop Forged Hardened Steel Construction
- Made from Solid Hex Bar Stock
- Flat End for Prying and Lifting
- High-Leverage Hook End with Deep "V" Nail Slot
- Durable Enamel Finish

Item	Description	Packaging	Cs	In
3323	12" Wrecking Bar	Color Label	48	6
3324	18" Wrecking Bar	Color Label	24	6



3344

3346

Rolling Head Pry Bar Sets

- Drop Forged Hardened Steel Construction
- Slim Tapered End with Fine Point Tip for Aligning Parts
- Rolling Head Hook End Delivers Maximum Leverage
- Durable Baked Enamel Finish

3344

- 2-pc. Pry Bars: 12", 16"

3346

- 4-pc. Pry Bars: 6", 12", 16", 20"

Item	Description	Packaging	Cs	In
3344	2-pc. Rolling Head Pry Bar Set	Sealed Blister	24	4
3346	4-pc. Rolling Head Pry Bar Set	Sealed Blister	12	6



5-pc. Mechanic's Pry Bar Set

Mechanic's Pry Bars

- Rugged Hardened Square Stock Steel Shafts
- Durable Black Oxide Finish
- Sharpened, Beveled-End Angled Tips Slip into Tight Spots
- Oversized Mechanic's-Style Handles for Sure Grip

Rolling Head Pry Bar

- Drop Forged Hardened Steel Construction
- Slim Tapered End with Fine Point Tip for Aligning Parts
- Rolling Head Hook End Delivers Maximum Leverage
- Durable Baked Enamel Finish

- 4-pc. Pry Bars: 8", 12", 18", 24"
- 1-pc. Rolling Head Pry Bar: 16"

Item	Description	Packaging	Cs	In
3350	5-pc. Mechanic's Pry Bar Set	Slide Blister Card	10	2



4-pc. Mechanic's Pry Bar Set

- Rugged Hardened Square Stock Steel Shafts
 - Durable Black Oxide Finish
 - Sharpened, Bevel-End Angled Tips Slip into Tight Spots
 - Oversized Countoured Handles for Sure Grip
- 4-pc. Mechanic's Pry Bars: 8", 12", 18", 24"

Item	Description	Packaging	Cs	In
3352	4-pc. Mechanic's Pry Bar Set	Sealed Blister	12	4



36" Jumbo Bent Tip Pry Bar

- Heat Treated Chrome Molybdenum Steel 5/8" Square Stock Shaft
- 30° Bent Tip for Extra Leverage
- Oversized Two-Hand Round Handle with Non-Slip Rubber Grips

Item	Description	Packaging	Cs	In
3361	36" Jumbo Bent Tip Pry Bar	Color Label	10	5

58 Pliers and Snips



Slip Joint Pliers

- Drop Forged, Heat Treated Steel Construction
- Precision-Machined Curved/Flat Combination Jaws
- Shear-Type Wire Cutter
- Corrosion-Resistant Chrome Plated Finish
- Cushioned Non-Slip Handle Grips
- Meets or Exceeds ANSI Standards

- 3445
• 3-pc. Slip Joint Pliers: 6", 8", 10"

Item	Description	Packaging	Cs	In
3445	3-pc. Slip Joint Pliers Set	Sealed Blister	25	5
3462	6" Slip Joint Pliers	Hang Card	120	6
3467	8" Slip Joint Pliers	Hang Card	60	6
3471	10" Slip Joint Pliers	Hang Card	24	6



Long Nose Pliers

- Drop Forged, Heat Treated Steel Construction
- Precision-Machined Long Nose Jaws
- Sharp, High Frequency Treated Wire Cutters
- Cushioned Non-Slip Handle Grips
- Meets or Exceeds ANSI Standards

Item	Description	Packaging	Cs	In
3507	6" Long Nose Pliers	Hang Card	60	6
3511	8" Long Nose Pliers	Hang Card	60	6
3517	6" 45° Bent Long Nose Pliers	Hang Card	60	6
3518	8" 45° Bent Long Nose Pliers	Hang Card	60	6
3520	6" 90° Bent Long Nose Pliers	Hang Card	60	6



Groove Joint Pliers

- Drop Forged, Heat Treated Steel Construction
- Precision-Milled Non-Slip Tongue and Groove Design Adjusts and Locks Jaw Capacity
- Durable Chrome Plated Finish
- Cushioned Non-Slip Handle Grips
- Meets or Exceeds ANSI Standards

- 3583
• 1-pc. 6" Groove Joint Pliers
• 1-pc. 8" Groove Joint Pliers
• 1-pc. 10" Groove Joint Pliers
• 1-pc. 12" Groove Joint Pliers
• Complete with Roll-up Storage Pouch

- 3582
• Brushed Finish

Item	Description	Packaging	Cs	In
3582	16" Groove Joint Pliers	Hang Card	16	4
3583	4-pc. Groove Joint Pliers Set	Sealed Blister	20	5
3586	6" Groove Joint Pliers	Hang Card	120	6
3587	8" Groove Joint Pliers	Hang Card	96	6
3588	10" Groove Joint Pliers	Hang Card	60	6
3589	12" Groove Joint Pliers	Hang Card	40	5



End Nipper Pliers

- Drop Forged, Heat Treated Steel Construction
- Precision-Machined Jaws
- Sharp High-Frequency Treated Cutting Edges
- Cushioned Non-Slip Handle Grips

Item	Description	Packaging	Cs	In
3525	6" End Nipper Pliers	Hang Card	60	6
3530	8" End Nipper Pliers	Hang Card	60	6



Diagonal Cut Pliers

- Drop Forged, Heat Treated Steel Construction
- Precision-Machined Jaws
- Sharp High-Frequency Treated Cutting Edges
- Cushioned Non-Slip Handle Grips

Item	Description	Packaging	Cs	In
3527	6" Diagonal Cut Pliers	Hang Card	60	6
3531	7" Diagonal Cutting Pliers	Hang Card	60	6

Linesman Pliers

3536 - 3546

- Drop Forged, Heat Treated Steel Construction
- Precision-Machined Upper and Lower Gripping Jaws
- Sharpened Wire Cutter
- Cushioned Non-Slip Handle Grips
- Meets or Exceeds ANSI Standards

3548

- Professional-Grade, Drop Forged, Heat Treated Steel Construction
- Precision-Machined Upper and Lower Gripping Jaws
- Sharpened Wire Cutter
- Wire and Terminal Crimper
- Cushioned Non-Slip Handle Grips
- Meets or Exceeds ANSI Standards



Item	Description	Packaging	Cs	In
3536	6" Linesman Pliers	Hang Card	60	6
3540	7" Linesman Pliers	Hang Card	60	6
3546	8" Linesman Pliers	Hang Card	60	6
3548	10" Heavy Duty Linesman Pliers	Hang Card	36	6

10" Fencing Pliers

- Drop Forged, Heat Treated Steel Construction
- Precision-Machined Multi-Function Jaws
- Cushioned Non-Slip Handle Grips
- Seven Tools in One: Two Wire Splicing Crimpers, Milled Hammer Face, Staple Puller Claw, Two Shear-Type Wire Cutters, and Gripping Jaws

Item	Description	Packaging	Cs	In
3566	10" Fencing Pliers	Hang Card	36	6



6-pc. Utility Pliers Set

- Drop Forged, Heat Treated Steel Construction
 - Precision-Machined Jaws
 - Cushioned Non-Slip Handle Grips
 - Meets or Exceeds ANSI Standards
- 1-pc. 6" Slip Joint Pliers (no. 3462)
 - 1-pc. 8" Slip Joint Pliers (no. 3467)
 - 1-pc. 6-1/2" Diagonal Cutting Pliers (no. 3527)
 - 1-pc. 8" Linesman Pliers (no. 3546)
 - 1-pc. 8" Long Nose Pliers (no. 3511)
 - 1-pc. 10" Groove Joint Pliers (no. 3588)

Item	Description	Packaging	Cs	In
3561	6-pc. Utility Pliers Set	Sealed Blister	12	6



3-pc. Utility Pliers Set

- Drop Forged, Heat Treated Steel Construction
- Precision-Machined Jaws with Polished Finish
- Cushioned Non-Slip Handle Grips
- Meets or Exceeds ANSI Standards

3552

- 1-pc. 6" Diagonal Cut Pliers
- 1-pc. 8" Linesman Pliers
- 1-pc. 8" Long Nose Pliers

3560

- 1-pc. 6" Slip Joint Pliers
- 1-pc. 8" Long Nose Pliers
- 1-pc. 10" Groove Joint Pliers



Item	Description	Packaging	Cs	In
3552	3-pc. Utility Pliers Set	Sealed Blister	20	5
3560	3-pc. Utility Pliers Set	Sealed Blister	24	6

60 Pliers and Snips

NEW

3463



3468



Slip Joint Pliers

- Forged and Hardened Chrome Vanadium Steel
- Corrosion-Resistant Black Nickel Finish
- Combination Jaws Grip Flat and Round Objects
- Shear-Type Wire Cutter
- Non-Slip Soft Handle Grips
- Meets or Exceeds ANSI Standards

Item	Description	Packaging	Cs	In
3463	6" Slip Joint Pliers	Hang Card	64	8
3468	8" Slip Joint Pliers	Hang Card	64	8

NEW

3510



3512



3523



Long Nose Pliers

- Forged and Hardened Chrome Vanadium Steel
- Corrosion-Resistant Black Nickel Finish
- Precision-Machined Upper and Lower Jaws
- Sharp, High Frequency Treated Wire Cutter
- Non-Slip Soft Handle Grips
- Meets or Exceeds ANSI Standards

Item	Description	Packaging	Cs	In
3510	6-1/2" Long Nose Pliers	Hang Card	64	8
3512	8" Long Nose Pliers	Hang Card	64	8
3523	6" 45° Bent Long Nose Pliers	Hang Card	64	8

NEW

3585



3590



3591



Groove Joint Pliers

- Forged and Hardened Chrome Vanadium Steel
- Corrosion-Resistant Black Nickel Finish
- Non-Slip Soft Handle Grips
- Non-Slip Tongue and Groove Design Adjusts and Locks Jaw
- Meets or Exceeds ANSI Standards

Item	Description	Packaging	Cs	In
3585	8" Groove Joint Pliers	Hang Card	64	8
3590	10" Groove Joint Pliers	Hang Card	48	8
3591	12" Groove Joint Pliers	Hang Card	40	8

7" Diagonal Cutting Pliers

- Forged and Hardened Chrome Vanadium Steel
- Corrosion-Resistant Black Nickel Finish
- Sharp, High Frequency Treated Cutting Edges
- Non-Slip Soft Handle Grips
- Meets or Exceeds ANSI Standards

Item	Description	Packaging	Cs	In
3529	7" Diagonal Cutting Pliers	Hang Card	64	8



8" Linesman Pliers

- Forged and Hardened Chrome Vanadium Steel
- Corrosion-Resistant Black Nickel Finish
- Precision-Machined Upper and Lower Jaws
- Sharp, High Frequency Treated Wire Cutter
- Non-Slip Soft Handle Grips
- Meets or Exceeds ANSI Standards

Item	Description	Packaging	Cs	In
3547	8" Linesman Pliers	Hang Card	64	8



10" Fencing Pliers

- Forged and Hardened Carbon Steel
- Corrosion-Resistant Black Nickel Finish
- 7 Tools in 1:
 - Hammer Head
 - 2 Wire Splicing Crimpers
 - Staple Puller
 - 2 Shear-Type Wire Cutters
 - Gripping Jaws
- Non-Slip Soft Handle Grips
- Meets or Exceeds ANSI Standards

Item	Description	Packaging	Cs	In
3567	10" Fencing Pliers	Hang Card	36	6



4-pc. Pliers and Wrench Set

- Forged and Hardened Chrome Vanadium Steel
- Corrosion-Resistant Black Nickel Finish
- Precision-Machined Jaws
- Non-Slip, Cushioned Handle Grips
- Meets or Exceeds ANSI Standards
- 1-pc. 6" Slip Joint Pliers
- 1-pc. 6" Long Nose Pliers
- 1-pc. 8" Groove Joint Pliers
- 1-pc. 6" Adjustable Wrench

Item	Description	Packaging	Cs	In
3563	4-pc. Pliers and Wrench Set	Sealed Blister	24	6



62 Pliers and Snips



Flex Grip Pliers

- Drop Forged, Fully Hardened Steel
- Precision-Machined Jaws
- Sharp, High Frequency Treated Wire Cutters
- Flex Grip Self-Opening Spring-Loaded Handles
- Cushioned Non-Slip Handle Grips
- Meets or Exceeds ANSI Standards

Item	Description	Packaging	Cs	In
35072	6-1/2" Flex Grip Long Nose Pliers	Plastic Hang Tab/Label	60	6
35073	8" Flex Grip Long Nose Pliers	Plastic Hang Tab/Label	60	6
35074	6-1/2" Flex Grip 45° Bent Nose Pliers	Plastic Hang Tab/Label	60	6
35075	8" Flex Grip 45° Bent Nose Pliers	Plastic Hang Tab/Label	60	6
35076	6-1/2" Flex Grip Diagonal Cut Pliers	Plastic Hang Tab/Label	60	6
35077	7-1/2" Flex Grip Diagonal Cut Pliers	Plastic Hang Tab/Label	60	6
35078	8" Flex Grip Linesman Pliers	Plastic Hang Tab/Label	60	6



Long Reach Pliers

- Drop Forged, Heat Treated Carbon Steel
- Fully Polished Finish
- Precision-Machined Jaws
- Cushioned Non-Slip Handle Grips
- Long Reach Design for Tight Work Areas
- Meets or Exceeds ANSI Standards



Item	Description	Packaging	Cs	In
3490	11" Long Reach Long Nose Pliers	Hang Card	60	6
3491	11" Long Reach 45° Bent Nose Pliers	Hang Card	60	6
3492	11" Long Reach 90° Bent Nose Pliers	Hang Card	60	6
3493	11" Long Reach 15° Bent Nose Pliers	Hang Card	60	6
3494	11" Long Reach Duckbill Pliers	Hang Card	60	6
3495	11" Long Reach Hose Ring Pliers	Hang Card	60	6
3532	11" Long Reach Diagonal Cut Pliers	Hang Card	60	6
3533	11" Long Reach 45° Offset Diagonal Cut Pliers	Hang Card	60	6



Precision Pliers

- Drop Forged, Heat Treated Steel Construction
- Spring-Loaded Self-Opening Hinge
- Cushioned Non-Slip Handle Grips
- Precision-Machined Jaws
- Sharp, High Frequency Treated Wire Cutters
- Meets or Exceeds ANSI Standards



- | | |
|---|---|
| <p>3592</p> <ul style="list-style-type: none"> • 1-pc. Long Nose • 1-pc. 45° Bent Long Nose • 1-pc. Linesman • 1-pc. End Nipper • 1-pc. Diagonal Cut | <p>3596</p> <ul style="list-style-type: none"> • 1-pc. 4-3/4" Long Nose • 1-pc. 4-1/2" Diagonal • 1-pc. 4-3/4" Bent Nose |
|---|---|



Item	Description	Packaging	Cs	In
3504	Precision Needle Nose Pliers	Hang Card	120	12
3506	Precision Long Nose Pliers	Hang Card	120	6
3516	Precision 45° Bent Long Nose Pliers	Hang Card	120	12
3522	Precision End Nipper Pliers	Hang Card	120	12
3526	Precision Diagonal Cut Pliers	Hang Card	120	12
3534	Precision Linesman Pliers	Hang Card	120	12
3592	5-pc. Precision Pliers Set	Sealed Blister	30	5
3596	3-pc. Precision Pliers Set	Sealed Blister	60	6

5-pc. Utility Pliers Set

- Drop Forged, Heat Treated Steel Construction
- Precision-Machined Jaws
- Cushioned Non-Slip Handle Grips
- General-Purpose Project Assortment for Auto, Garage, and Home

- 1-pc. 6" Diagonal Cut Pliers
- 1-pc. 8" Long Nose Pliers
- 1-pc. 8" Linesman Pliers
- 1-pc. 5-in-1 Combination Tool
- 1-pc. 10" Locking Pliers



Item	Description	Packaging	Cs	In
3557	5-pc. Utility Pliers Set	Sealed Blister	20	5



Locking Pliers

- Drop Forged Hardened Steel Jaws
- Rugged 5-Rivet Construction
- Durable Chrome Plated Finish
- Knurled Thumbscrew Sets Jaw Capacity
- Anvil-Type Wire Cutter

Item	Description	Packaging	Cs	In
3701	5" Curved Jaw Locking Pliers	Hang Card	72	6
3706	7" Curved Jaw Locking Pliers	Hang Card	60	6
3707	7" Straight Jaw Locking Pliers	Hang Card	60	6
3711	10" Curved Jaw Locking Pliers	Hang Card	48	6
3712	10" Straight Jaw Locking Pliers	Hang Card	60	6



Long Nose Locking Pliers

- Drop Forged Hardened Steel Jaws
- Rugged 5-Rivet Construction
- Durable Chrome Plated Finish
- Knurled Thumbscrew Sets Jaw Capacity
- Anvil-Type Wire Cutter

Item	Description	Packaging	Cs	In
3719	6" Long Nose Locking Pliers	Hang Card	72	6
3721	9" Long Nose Locking Pliers	Hang Card	72	12



3-pc. Locking Pliers Set

- Drop Forged Hardened Steel Jaws
- Rugged 5-Rivet Construction
- Durable Chrome Plated Finish
- Knurled Thumbscrew Sets Jaw Capacity
- Anvil-Type Wire Cutter
- 3-pc. Locking Pliers: 5", 7", 10"
- Complete with Roll-up Storage Pouch

Item	Description	Packaging	Cs	In
3730	3-pc. Locking Pliers Set	Color Box	20	1



Locking Pliers

- Forged and Hardened Chrome Vanadium Steel Jaws
- Combination Curved/Straight Jaws Grip Round and Flat Objects
- Anvil-Type Wire Cutter
- Rugged Welded and Riveted Construction
- Corrosion-Resistant Nickel Plated Finish
- Non-Slip Soft Handle Grips
- Meets or Exceeds ANSI Standards

Item	Description	Packaging	Cs	In
3702	5" Locking Pliers	Hang Card	72	6
3708	7" Locking Pliers	Hang Card	64	8
3713	9" Locking Pliers	Hang Card	48	6



6-in-1 Snap Ring Pliers Set

- Heat Treated Carbon Steel Construction
- Corrosion-Resistant Black Oxide Finish
- Precision-Machined and Hardened Universal Interchangeable Tips
- Self-Opening, Spring-Loaded Handles
- Comfortable, Cushioned Non-Slip Grips
- Size Range: Internal: 1/4" - 1-3/4", External: 1/4" - 2-1/2", Tip Diameter: .040" and .050"

- 1-pc. External Pliers
- 1-pc. Internal Pliers
- 2-pc. Straight Tip (.040")
- 2-pc. Straight Tip (.050")
- 2-pc. 45° Bent Tip (.050")
- 2-pc. 90° Bent Tip (.050")
- Complete with Tip Storage Case

Item	Description	Packaging	Cs	In
3570	6-in-1 Snap Ring Pliers Set	Slide Blister Card	72	12



8-in-1 Universal Snap Ring Pliers Set

- Heat Treated Carbon Steel Construction
- Corrosion-Resistant Black Oxide Finish
- Precision-Machined Tips
- Self-Opening, Spring-Loaded Handles
- Comfortable, Cushioned Non-Slip Grips
- Universal Internal/External Heads
- Size Range: Internal: 3/4" - 1-3/4", External: 1" - 2-1/2", Tip Size: .060"

- 2-pc. Straight Tip Heads
- 1-pc. 45° Bent Tip Head
- 1-pc. 90° Bent Tip Head
- 1-pc. Handle Assembly
- Complete with Storage Case

Item	Description	Packaging	Cs	In
3578	8-in-1 Universal Snap Ring Pliers Set	Color Label	24	6



Snap Ring Pliers

- Drop Forged, Heat Treated High-Carbon Steel
- Precision-Machined, Black Oxide Finished Tips
- Self-Opening Spring-Loaded Handles
- Cushioned Non-Slip Handle Grips

3576

- 1-pc. 6" Internal Bent Tip
- 1-pc. 6" Internal Straight Tip
- 1-pc. 6" External Bent Tip
- 1-pc. 6" External Straight Tip

Item	Description	Packaging	Cs	In
3571	7" Internal Bent Tip Snap Ring Pliers	Hang Card	72	6
3572	7" External Bent Tip Snap Ring Pliers	Hang Card	72	6
3573	7" Internal Snap Ring Pliers	Hang Card	72	6
3574	7" External Snap Ring Pliers	Hang Card	72	6
3576	4-pc. Heavy Duty Snap Ring Pliers	Sealed Blister	30	5



5-pc. Snap Ring Pliers Set

- Heat Treated Carbon Steel Construction
- Durable Black Oxide Finish
- Precision-Machined Tips
- Cushioned Non-Slip Handle Grips
- Reversible Jaws Convert Pliers for Use with Both Internal and External Snap Rings
- Size Range: Internal: 3/4" - 1-3/4", External: 3/4" - 2-1/2", Tip Size: .060" and .090"

- 2-pc. 6" Straight Tip (.060")
- 1-pc. 6" 90° Bent Tip (.060")
- 1-pc. 8" Straight Tip (.090")
- 1-pc. 8" 90° Bent Tip (.090")

Item	Description	Packaging	Cs	In
3580	5-pc. Snap Ring Pliers Set	Color Box	24	6

66 Pliers and Snips



Bolt Cutters

- Drop Forged Hardened Alloy Steel Jaws
- Compound Cutting Action Requires Less Effort
- Tubular Steel Handles with Cushioned Non-Slip Rubber Grips
- Adjustable and Replaceable Jaws
- Cuts Bolts, Chain, Threaded Rod, and More

3386

- Drop Forged Hardened Alloy Steel Jaws
- Compound Cutting Action Requires Less Effort
- Rolled Steel Handles with Cushioned Non-Slip Rubber Grips
- Cuts Bolts, Chain, Threaded Rod, and More

Item	Description	Packaging	Cs	In
3386	8" Bolt Cutter	Hang Card	36	6
3388	12" Bolt Cutter	Color Label	12	1
3391	14" Bolt Cutter	Color Label	10	1
3400	18" Bolt Cutter	Color Label	10	1
3410	24" Bolt Cutter	Color Label	10	1
3416	30" Bolt Cutter	Color Label	5	1
3421	36" Bolt Cutter	Color Label	5	1



Aviation Tin Snips

- Forged and Hardened High Carbon Alloy Steel Jaws
- Serrated Cutting Edges
- Compound Hinge Delivers More Force with Less Effort
- Non-Slip Cushioned Handle Grips Reduce Fatigue
- Handle Lock for Safe Storage

Item	Description	Packaging	Cs	In
3636	Right Cut Aviation Tin Snips	Slide Blister Card	40	8
3641	Left Cut Aviation Tin Snips	Slide Blister Card	40	8
3646	Straight Cut Aviation Tin Snips	Slide Blister Card	40	8



Straight Pattern Tin Snips

- Drop Forged, Heat Treated, High Carbon Steel
- Polished Finish Resists Corrosion
- Rugged, Hardened Cutting Edges
- Comfortable, Non-Slip Cushioned Grips Reduce Fatigue

Item	Description	Packaging	Cs	In
3655	8" Straight Pattern Tin Snips	Hang Card	36	6
3660	10" Straight Pattern Tin Snips	Hang Card	36	6
3665	12" Straight Pattern Tin Snips	Hang Card	24	4

5-in-1 Combination Tool

- Hardened Steel Construction
- High-Contrast Size Range Markings
- Non-Slip Cushioned Fingergrip Handles
- Cuts and Rethreads Bolt Sizes 4-40, 6-32, 8-32, 10-24, and 10-32
- Strips Solid or Stranded 10-22 AWG wire
- Crimps Wire Terminal Sizes 10-12, 14-16, and 18-22 AWG
- Anvil-Type Wire Cutter
- Ignition Terminal Crimper
- 7-1/2" Length

Item	Description	Packaging	Cs	In
3761	5-in-1 Combination Tool	Slide Blister Card	72	6



8-in-1 Electrician's Combination Tool

- Hardened Steel Construction
- High-Contrast Size Range Markings
- Non-Slip Cushioned Handle Grips
- Cuts and Rethreads Bolt Sizes M3, 6-32, M4, 8-32, 10-32
- Strips Solid or Stranded 8-22 AWG wire
- Crimps Insulated Wire Terminal Sizes 10-22 AWG
- Crimps Non-Insulated Wire Terminal Sizes 10-22 AWG
- Anvil-Type Wire Cutter
- Shear-Type Wire and Fastener Cutter
- Ignition Terminal Crimper
- 9-3/4" Length

Item	Description	Packaging	Cs	In
3775	8-in-1 Electrician's Combination Tool	Slide Blister Card	36	6



Adjustable Wire Stripper

- Hardened Steel Construction
- Cuts and Strips Wire Sizes 10-24 AWG
- Set Screw Locks Wire Stripper Capacity
- Looping Holes Bend Wire for Proper Fit Around Screw Terminals
- Self-Opening Spring-Loaded Hinge
- 4" Length

Item	Description	Packaging	Cs	In
3794	Adjustable Wire Stripper	Slide Blister Card	120	12



Wire Stripper/Crimper

- Hardened Steel Construction
- Strips Solid and Stranded Wire Sizes 10-18 AWG
- Crimps Wire Terminal Sizes 14-24 AWG
- Shear-Type Wire Cutter
- Looping Holes Bend Wire for Proper Fit Around Screw Terminals
- Self-Opening Spring-Loaded Hinge
- Non-Slip Cushioned Handle Grips
- 6" Length

Item	Description	Packaging	Cs	In
3796	Wire Stripper/Crimper	Slide Blister Card	120	12





Rosin Core Solder

- General Purpose Lead-Free Rosin Core Solder
- Solder Composition: 100% Sn
- Melting Range: 227-229°C
- Convenient Dispensing Storage Container
- Net Weight: 5 oz.

Item	Description	Packaging	Cs	In
7262	Rosin Core Solder	Slide Blister Card	72	2



30-Watt Soldering Iron

- Insulated Pencil-Type Polymer Handle
- Replaceable Nickel Plated Tip
- UL Listed
- Complete with Tip Stand
- General-Purpose Soldering Iron for Electronics Repair, Wiring Connections, Automotive Electrical System Repairs, and Circuit Boards

Specifications:

- Max. Tip Temperature: 700°
- Power Usage: 110-120V, 30W
- Cord Length: 5-1/2'

Item	Description	Packaging	Cs	In
7266	30-Watt Soldering Iron	Slide Blister Card	100	5



100-Watt Soldering Gun

- Insulated Polymer Body with Comfortable Pistol-Grip Handle
- Trigger Action Instantly Heats Tip
- Built-in Worklight Provides Focused Illumination
- Replaceable Nickel Plated Tips
- UL Listed
- General-Purpose Soldering Gun for Electronics Repair, Wiring Connections, and Automotive Electrical System Repairs

Specifications:

- Max. Tip Temperature: 700°
- Power Usage: 110-120V, 100W
- Cord Length: 5'

- 1-pc. Soldering Gun
- 1-pc. Chisel Tip
- 1-pc. Soldering Tip
- 1-pc. Tip Wrench
- 1-pc. Solder Dispenser
- 1-pc. Flux

Item	Description	Packaging	Cs	In
7278	100-Watt Soldering Gun	Sealed Blister	24	4



3/4" x 60' Vinyl Electrical Tape

- Stretchy Vinyl Tape Conforms to Irregular Contours
- General Purpose
- UL Listed
- Suitable for use up to 600V and 80°C (176°F)
- Black, 3/4" x 60' x 7mil

Item	Description	Packaging	Cs	In
7375	3/4" x 60' Vinyl Electrical Tape	Color Label	240	10



5-pc. Color Vinyl Tape

- Standard-Grade Vinyl Tape with Medium Adhesion
- Ideal for Marking and Color Coding Applications
- Roll Length: 12'
- Roll Width: 3/4"
- Thickness: 7 mil

Item	Description	Packaging	Cs	In
7385	5-pc. Color Vinyl Tape	Slide Blister Card	100	10



16-Range Electric Multi-Tester

- Super Sensitive Meter is Diode Protected
- Easy-to-Read Color Coded Scale
- Pocket Sized for Easy Storage
- Hundreds of Uses for Home, Auto, Small Engines, Projects, Hobbies, etc.
- Power Source: One "AA" Battery (Included)

Test Ranges:

- AC-V: 0-10V-50V-250V-500V
- DC-V: 0-2.5V-10V-50V-250V-500V
- DC-A: 0-500 μ A-10mA-250mA
- Resistance: 0-10 Ohm-1 kOhm (1Megohm Max.)
- Battery: 1.5-9V

- 1-pc. Multi-Tester
- 2-pc. Test Leads (Red and Black)
- 1-pc. "AA" Battery

Item	Description	Packaging	Cs	In
5898	16-Range Electric Multi-Tester	Slide Blister Card	40	5



Battery, Bulb and Fuse Tester

Tests:

- Voltage of AAA, AA, C, D, 9-Volt and Button Cell Batteries
- Continuity of Standard Appliance, Household, Automotive and Decorative Light Bulbs
- Continuity of Glass-Type and Blade-Type Fuses
- Tests General Purpose, Alkaline and Rechargeable Batteries
- Accurately Checks Battery Capacity Under Simulated Load Conditions
- Reduce Waste and Save Unnecessary Expense - Check Batteries, Bulbs, and Fuses before Replacing
- Troubleshoot Electronic Devices by Verifying Battery Output
- Easy-Read Analog Meter
- Requires 9-Volt Battery (not Included)

Item	Description	Packaging	Cs	In
7333	Battery, Bulb and Fuse Tester	Slide Blister Card	24	6



Digital Multi-Tester

- Diode and Fuse Protected
- Easy-Read Digital LCD Display
- 7 Functions and 19 Ranges: Measures AC/DC Voltage, DC Current, Resistance and Tests Transistors, Diodes, Continuity and Batteries
- Power Source: One 9-Volt Battery (Included)

Test Ranges:

- AC-V: 0-200-750V
- DC-V: 0-200mV-2000mV-20V-200V-1000V
- DC-A: 0-200 μ A-2000 μ A-20mA-200mA-10A
- Resistance: 0-200 Ohm-2000 Ohm-20 kOhm-200 kOhm-2000 kOhm
- Battery: 1.5-9V

- 1-pc. Multi-Tester
- 2-pc. Test Leads (Red and Black)
- 1-pc. 9-Volt Battery

Item	Description	Packaging	Cs	In
5899	Digital Multi-Tester	Slide Blister Card	48	6



110-460 V Voltage Tester

- Tests AC and DC Circuits
- Four Voltage Ranges: 110V, 220V, 277V, 460V
- Tests Voltage, Polarity, and Grounding
- Lamps Glow when Voltage is Present
- Insulated Housing with Pocket Clip

Item	Description	Packaging	Cs	In
7337	110-460 V Voltage Tester	Slide Blister Card	100	10



3-Wire Receptacle Tester

- Detects Faulty Wiring Conditions in 3-Prong 110-125V AC Receptacles
- Color-Coded Indicator Lights
- Simple to Use - Plugs into Outlet Like any Electrical Cord
- Indicates Open Ground, Open Neutral, Open Hot, Hot/Ground Reverse, Hot/Neutral Reverse, and Correct Wiring Conditions
- UL-Listed

Item	Description	Packaging	Cs	In
7338	3-Wire Receptacle Tester	Slide Blister Card	144	12



4-pc. Tweezer Set

- Stainless Steel Construction
- Non-Slip Knurled Grips
- Use for Electronics Repair, Precision Assembly, and Models
- 4-1/2" Overall Length
- 1-pc. Straight Fine Tip
- 1-pc. Bent Broad Tip
- 1-pc. 45° Angle Fine Tip
- 1-pc. Reverse Action Fine Tip

Item	Description	Packaging	Cs	In
7490	4-pc. Tweezer Set	Slide Blister Card	96	6



Helping Hand with Magnifier

- Heavy Duty Cast Iron Base
- 2-1/2", 2X Magnifying Glass for Precision Work without Eyestrain
- Dual Alligator Spring Clamps Hold Workpiece Steady
- Mirror and Clamps are Mounted on Adjustable Ball Joints to Position and View Work at any Angle
- Frees Hands for Soldering, Gluing, Positioning, Fastening, and Assembly

Item	Description	Packaging	Cs	In
7521	Helping Hand with Magnifier	Sealed Blister	12	6



500-pc. Cable Ties

- Strong Nylon Construction
- Self-Locking Teeth will not Loosen
- Use Assorted Colors to Organize Groups of Wires, Cables or Hoses

- 500-pc. 4" (3/32") Cable Ties:
 - 100-pc. Orange
 - 100-pc. Green
 - 100-pc. Yellow
 - 100-pc. Black
 - 100-pc. White
- Complete with Storage Canister

Item	Description	Packaging	Cs	In
6233	500-pc. Cable Ties	Tube/Color Label	48	6



200-pc. Assorted Cable Ties

- Strong Nylon Construction
- Self-Locking Teeth will not Loosen
- Use Assorted Colors to Organize Groups of Wires, Cables or Hoses

- 125-pc. 4" (3/32") Cable Ties:
 - 25-pc. Orange
 - 25-pc. Green
 - 25-pc. Yellow
 - 25-pc. Black
 - 25-pc. White
- 50-pc. 8" (1/8") Cable Ties:
 - 18-pc. Orange
 - 16-pc. Black
 - 16-pc. White
- 25-pc. 12" (3/16") Cable Ties: Black
- Complete with Storage Canister

Item	Description	Packaging	Cs	In
6235	200-pc. Assorted Cable Ties	Tube/Color Label	72	6



Locking "C" Clamps

- Drop Forged Carbon Steel Jaws
- Corrosion-Resistant Chrome Plated Finish
- Knurled Thumbscrew Sets Jaw Capacity
- One-Touch Quick Release

Item #	Jaw Capacity
3815	1-1/2"
3825	3"
3835	7"

Item	Description	Packaging	Cs	In
3815	6" Locking "C" Clamp	Hang Card	72	6
3825	11" Locking "C" Clamp	Hang Card	30	6
3835	18" Locking "C" Clamp	Hang Card	24	6



Locking "C" Clamps with Swivel Jaw Pads

- Drop Forged Hardened Steel Jaws
- Durable Chrome Plated Finish
- Self-Leveling Swivel Jaw Pads
- Knurled Thumbscrew Sets Jaw Capacity
- One-Touch Quick Release

Item #	Jaw Capacity
3816	1-3/4"
3826	2-1/2"
3836	7"

Item	Description	Packaging	Cs	In
3816	6" Swivel Pad Locking "C" Clamp	Hang Card	72	6
3826	11" Swivel Pad Locking "C" Clamp	Hang Card	30	5
3836	18" Swivel Pad Locking "C" Clamp	Hang Card	24	6

Welding and Sheet Metal Clamps

3850

- Drop Forged Carbon Steel Jaws
- Corrosion-Resistant Chrome Plated Finish
- Knurled Thumbscrew Sets Jaw Capacity
- One-Touch Quick Release
- Deep Jaws Hold Angle and Bar Stock

3855

- Drop Forged Carbon Steel Jaws
- Corrosion-Resistant Chrome Plated Finish
- Knurled Thumbscrew Sets Jaw Capacity
- One-Touch Quick Release
- Flat Jaws Hold and Crimp Sheet Metal

Item	Description	Packaging	Cs	In
3850	9" Welding Clamp	Slide Blister Card	30	6
3855	8" Sheet Metal Clamp	Slide Blister Card	30	6



Locking Chain Clamp

- Creates a Non-Slip, Locking Grip on Round or Irregular Shapes
- Hardened Carbon Steel Handles
- Corrosion-Resistant Chrome Plated Finish
- Knurled Thumbscrew Sets Jaw Capacity
- One-Touch Quick Release

Specifications:

- 5-1/2" Diameter Maximum Capacity
- 9" Handle Length

Item	Description	Packaging	Cs	In
3960	Locking Chain Clamp	Slide Blister Card	30	6





4-pc. 4" Steel Spring Clamps

- Nickel Plated Steel Construction
- Soft Non-Slip Handle Grips
- Non-Slip Padded Jaws Grip Workpiece without Damaging Surface
- Tempered Steel Spring for Consistent Holding Power
- 1-1/4" Jaw Capacity

Item	Description	Packaging	Cs	In
3896	4-pc. 4" Steel Spring Clamps	Poly Bag/Hang Card	72	12



2" Mini Steel Spring Clamps

- Chrome Plated Steel Construction
- Soft Non-Slip Handle Grips
- Non-Slip Padded Jaws Grip Workpiece without Damaging Surface
- Tempered Steel Spring for Consistent Holding Power
- 3/4" Jaw Capacity

- MINIMUM ORDER QUANTITY:
10-PC. POLYBAG

Item	Description	Packaging	Cs	In
3902	2" Mini Steel Spring Clamps	Poly Bag/No Label	1000	10



Steel Spring Clamps

- Chrome Plated Steel Construction
- Soft Non-Slip Handle Grips
- Non-Slip Padded Jaws Grip Workpiece without Damaging Surface
- Tempered Steel Spring for Consistent Holding Power

Item #	Jaw Capacity
3906	1-1/4"
3911	2"
3916	3-1/2"

Item	Description	Packaging	Cs	In
3906	4" Steel Spring Clamp	Wrap or Tie Card	200	10
3911	6" Steel Spring Clamp	Wrap or Tie Card	120	10
3916	9" Steel Spring Clamp	Wrap or Tie Card	60	6



Spring Clamps

- Extra Strong Nylon and Fiberglass Construction
- Non-Slip Textured Handle Grips
- Wide Jaw Pads Pivot to Fit Workpiece for a Uniform Grip on Uneven Surfaces
- Tempered Steel Spring for Consistent Holding Power

Item #	Jaw Capacity
3903	1-1/4"
3907	1-1/4"
3912	2-1/2"
3917	3-1/2"

Item	Description	Packaging	Cs	In
3903	3" Spring Clamp	Wrap or Tie Card	288	24
3907	4" Spring Clamp	Wrap or Tie Card	200	10
3912	6" Spring Clamp	Wrap or Tie Card	100	10
3917	9" Spring Clamp	Wrap or Tie Card	40	10

Supergrip Spring Clamps

- Extra Strong Nylon and Fiberglass Construction
- Comfortable Cushioned Non-Slip Handle Grips
- Wide Jaw Pads Pivot to Fit Workpiece for a Uniform Grip on Uneven Surfaces
- Tempered Steel Springs for Consistent Holding Power

Item #	Jaw Capacity
3913	1-1/4"
3914	1-3/4"
3915	2-1/8"
3919	3-3/8"

Item	Description	Packaging	Cs	In
3913	3" Supergrip Spring Clamp	Wrap or Tie Card	288	24
3914	4" Supergrip Spring Clamp	Wrap or Tie Card	200	10
3915	6" Supergrip Spring Clamp	Wrap or Tie Card	100	10
3919	9" Supergrip Spring Clamp	Wrap or Tie Card	40	10



Ratchet Bar Clamps

- Super-Strong Nylon Jaw Assemblies
- Trigger Action Applies Precise Clamping Force
- Smooth, Silent, and Precise Ratcheting Action
- Position Jaw Instantly Along Bar with Quick Release Button
- Soft Jaw Pads will not Scratch or Mar Surfaces
- Bar Clamp Jaws Convert for Use as Spreaders

Item #	Jaw Capacity	Throat Depth
39180	6"	1.5"
39181	6"	2.5"
39182	12"	2.5"
39183	18"	2.5"
39184	24"	2.5"
39185	30"	2.5"
39186	36"	2.5"

Item	Description	Packaging	Cs	In
39180	6" x 1.5" Ratchet Bar Clamp	Wrap or Tie Card	144	6
39181	6" x 2.5" Ratchet Bar Clamp	Wrap or Tie Card	48	4
39182	12" x 2.5" Ratchet Bar Clamp	Wrap or Tie Card	36	4
39183	18" x 2.5" Ratchet Bar Clamp	Wrap or Tie Card	24	4
39184	24" x 2.5" Ratchet Bar Clamp	Wrap or Tie Card	24	3
39185	30" x 2.5" Ratchet Bar Clamp	Wrap or Tie Card	12	2
39186	36" x 2.5" Ratchet Bar Clamp	Wrap or Tie Card	12	2



Slide Locking Bar Clamps

- Malleable Steel Jaws, Heat Treated Steel Bar
- Chrome Plated Steel Screw with Swivel Pad
- Hardwood Screw Handle
- Precision Notched Steel Bar Holds Objects Safely At the Correct Tension for Gluing, Fastening, and Securing
- Quick-Slide Lock Allows Jaw to Move to Any Position with the Touch of a Button

Item #	Jaw Capacity	Throat Depth
3926	12"	2-1/2"
3927	14-1/2"	2-1/2"
3928	20-1/2"	2-1/2"
3929	32"	2-1/2"

Item	Description	Packaging	Cs	In
3926	12" x 2.5" Slide Locking Bar Clamp	Bulk/UPC	30	5
3927	18" x 2.5" Slide Locking Bar Clamp	Bulk/UPC	25	5
3928	24" x 2.5" Slide Locking Bar Clamp	Bulk/UPC	24	4
3929	36" x 2.5" Slide Locking Bar Clamp	Bulk/UPC	20	4



Gluing Clamps

- Strong, Malleable Steel Construction
- Use with Threaded Pipe to Make a Clamping Fixture of any Length
- Spring Lever Allows Jaw to Quickly Slide to Any Location and Lock in Place

Item #	Pipe Size	Throat Depth
3941	1/2"	1-1/4"
3946	3/4"	1-1/2"

Item	Description	Packaging	Cs	In
3941	1/2" Gluing Clamp	Sealed Blister	12	4
3946	3/4" Gluing Clamp	Sealed Blister	12	4





3-pc. Mini "C" Clamp Set

- Malleable Steel Frame
- Nickel Plated Steel Screw with Swivel Pad
- Sliding T-Bar Handle
- Durable Baked Enamel Finish

Jaw Opening	Throat Depth
1"	3/4"
2-1/2"	1-1/4"

Item	Description	Packaging	Cs	In
3982	3-pc. Mini "C" Clamp Set	Slide Blister Card	72	6



2-1/2" Heavy Duty Deep Throat "C" Clamp

- Heavy Duty Malleable Steel Frame
- Chrome Plated Steel Screw with Swivel Pad
- Sliding T-Bar Handle
- Durable Baked Enamel Finish
- 2-1/2" Throat Depth

Item	Description	Packaging	Cs	In
4008	2-1/2" Heavy Duty Deep Throat "C" Clamp	Hang Card	48	4



Item #	Jaw Opening	Throat Depth
4009	1"	1"
4011	2"	1-1/8"
4012	3"	1-1/2"
4017	4"	2-1/4"
4022	5"	2-3/8"
4027	6"	2-3/4"
4031	8"	3-3/8"
4035	10"	4-3/4"
4040	12"	5-1/8"

Heavy Duty "C" Clamps

- Heavy Duty Malleable Steel Frame
- Chrome Plated Steel Screw with Swivel Pad
- Sliding T-Bar Handle
- Durable Baked Enamel Finish

Item	Description	Packaging	Cs	In
4009	1" Heavy Duty "C" Clamp	Hang Card	72	12
4011	2" Heavy Duty "C" Clamp	Hang Card	72	12
4012	3" Heavy Duty "C" Clamp	Hang Card	48	6
4017	4" Heavy Duty "C" Clamp	Wrap or Tie Card	36	6
4022	5" Heavy Duty "C" Clamp	Wrap or Tie Card	24	4
4027	6" Heavy Duty "C" Clamp	Wrap or Tie Card	12	4
4031	8" Heavy Duty "C" Clamp	Wrap or Tie Card	12	3
4035	10" Heavy Duty "C" Clamp	Wrap or Tie Card	6	1
4040	12" Heavy Duty "C" Clamp	Wrap or Tie Card	6	1

Arrow Magnetic Welding Holders

- Powerful Magnet Riveted into Durable Steel Housing
- Holds Work at 45°, 90°, and 135° Angles
- Use for Hands-Free Positioning of Ferrous Metal Parts for Welding, Soldering, and Assembly

Item #	Max. Holding Cap.	Max. Lift Capacity
5217	50 LBS	35 LBS
5218	25 LBS	15 LBS
5219	75 LBS	50 LBS

Item	Description	Packaging	Cs	In
5217	50-lb. Magnetic Welding Holder	Slide Blister Card	36	6
5218	25-lb. Magnetic Welding Holder	Slide Blister Card	60	6
5219	75-lb. Magnetic Welding Holder	Slide Blister Card	24	6





Drill Press Vises

- Solid Cast Construction
- Replaceable Non-Slip Serrated Steel Jaws
- Chrome Plated, Cold Rolled Steel Screw
- 180° Pivoting Crank Handle
- Four-Slot Base for Precise Mounting Position

Item #	Jaw Width	Jaw Opening
5301	3"	3"
5306	4"	3-3/4"
5310	5"	4-1/2"
5315	6"	5-3/4"

Item	Description	Packaging	Cs	In
5301	3" Drill Press Vise	Color Box	10	1
5306	4" Drill Press Vise	Color Box	8	1
5310	5" Drill Press Vise	Color Box	4	1
5315	6" Drill Press Vise	Color Box	3	1



3" Universal Angle Vise

- Solid Cast Construction
- Replaceable Steel Jaws
- Chrome Plated, Cold Rolled Steel Screw
- 180° Pivoting Crank Handle with Knurled Grip
- Set Angle Positions from 0° (Horizontal) to 90° (Vertical)
- Six-Slot Base Mounts Securely to Work Surface

Jaw Width	Jaw Opening	Throat Depth
3"	3-1/2"	1-1/4"

Item	Description	Packaging	Cs	In
5325	3" Universal Angle Vise	Color Box	6	1

Swivel Bench Vises

5384 - 5400

- Solid Cast Construction
- 360° Swivel Base with Dual Lock Down Nuts
- Replaceable Non-Slip Steel Jaw Pads
- Chrome Plated Sliding T-Bar Handle
- Three-Slot Mounting Base

5409

- Malleable Steel Construction
- 360° Swivel Base with Dual Lock Down Nuts
- Replaceable Non-Slip Steel Jaw Pads
- Serrated Pipe Jaws
- Chrome Plated Sliding T-Bar Handle
- Three-Slot Mounting Base

Item #	Jaw Width	Jaw Opening	Throat Depth	Anvil Size	Pipe Jaw Capacity
5384	3"	4"	2"	2-3/4"	-
5385	4"	4-1/2"	2-1/4"	3-1/2"	1/2"
5395	5"	5"	2-1/2"	4-1/2"	1"
5400	6"	6"	3"	5-1/2"	1"
5409	8"	7-1/4"	3-1/2"	3-3/4"	1-1/2"

Item	Description	Packaging	Cs	In
5384	3" Swivel Bench Vise	Color Box	4	1
5385	4" Swivel Bench Vise	Color Box	2	1
5395	5" Swivel Bench Vise	Color Box	1	1
5400	6" Swivel Bench Vise	Color Box	1	1
5409	8" Swivel Bench Vise	Color Box	1	1



5384 - 5400



5409

5" Multi-Purpose Vise

- Solid Cast Construction
- 360° Swivel Base with Dual Lock Down Nuts
- 360° Rotating Head
- Replaceable Non-Slip Steel Jaw Pads
- Serrated Pipe Jaws
- Chrome Plated Sliding T-Bar Handle
- Three-Slot Mounting Base

Jaw Width	Jaw Opening	Throat Depth	Anvil Size	Pipe Jaw Capacity
5"	4-1/2"	3"	3 x 3-3/4"	1-1/2"

Item	Description	Packaging	Cs	In
5405	5" Multi-Purpose Vise	Color Box	1	1



76 Plumbing



Mini Tubing Cutters

- Rugged Cast Zinc Body
- Hardened Alloy Steel Cutting Wheel
- Large Knurled Knob for Precise Adjustment of Cutting Pressure
- Grooved Guide Rollers Ensure Square Cuts, Even Close to Flared Ends
- Compact Size for Use in Tight Work Areas
- Cuts Copper, Brass, Aluminum, Mild Steel (Thin-Wall) and Plastic

Item #	Pipe Capacity
6455	1/8" to 5/8" O.D.
6456	3/8" - 1-1/8" O.D.

Item	Description	Packaging	Cs	In
6455	Mini Tubing Cutter (1/8" - 5/8" O.D.)	Blister Card	240	12
6456	Mini Tubing Cutter (3/8" - 1-1/8" O.D.)	Slide Blister Card	120	12



Quick Adjust Tubing Cutter

- Rugged Cast Aluminum Frame
- Hardened Alloy Steel Cutting Wheel
- Quick-Release Sliding Screw Feed Arm Instantly Adjusts to Tube Size
- Large Knurled Knob for Precise Adjustment of Cutting Pressure
- Grooved Guide Rollers Ensure Square Cuts Even Close to Flared Ends
- Retractable Reamer Blade
- Cuts Copper, Brass, Aluminum, Mild Steel (Thin-Wall) and Plastic
- Pipe Capacity: 1/8" to 1-1/4" O.D.

Item	Description	Packaging	Cs	In
6461	Quick Adjust Tubing Cutter	Slide Blister Card	60	6



PVC Pipe Cutter

- Chrome Molybdenum Blade with Precision-Ground Cutting Edge
- Rugged, Lightweight, Cast Aluminum Body with Durable Baked Enamel Finish
- High-Leverage Ratchet Action for Smooth Cuts with Less Effort
- 1-5/8" Jaw Capacity
- Cuts All Types of PVC and Plastic Pipes and Vinyl Tubing
- Fast, Square Cut with no Burrs to Remove or Mess to Clean Up
- Uses #6470 Replacement Blade

Item	Description	Packaging	Cs	In
6466	PVC Pipe Cutter	Slide Blister Card	24	6
6470	PVC Pipe Cutter Blade	Skin Card	96	24



Tubing Cutter

- Rugged Cast Aluminum Frame
- Hardened Alloy Steel Cutting Wheel
- Large Knurled Knob for Precise Adjustment of Cutting Pressure
- Grooved Guide Rollers Ensure Square Cuts Even Close to Flared Ends
- Retractable Reamer Blade
- Cuts Copper, Brass, Aluminum, Mild Steel (Thin-Wall) and Plastic
- Pipe Capacity: 1/8" to 1-1/8" O.D.

Item	Description	Packaging	Cs	In
6460	Tubing Cutter	Slide Blister Card	60	6



Pipe Cutter

- Heavy Duty Malleable Steel Frame
- Hardened Alloy Steel Cutting Wheel
- Extra Large T-Handle Screw Feed for Precise Adjustment of Cutting Pressure
- Parallel Guide Rollers Ensure a Square Cut
- Cuts Copper and Thin-Walled Steel Pipe, Metal Conduit, Brass and Aluminum Tubing
- Pipe Capacity: 1/2" to 2" O. D.

Item	Description	Packaging	Cs	In
6463	Pipe Cutter	Color Box	10	1



Flaring Tool Set

- Precision-Machined, Threaded Steel Die Bar
- Six Die Sizes: 3/16", 1/4", 5/16", 3/8", 1/2", 5/8"
- Rugged, Solid Steel Yoke
- Hardened Center Screw with Sliding T-Bar Handle
- Produces 45° Flare Angle
- Use with Copper, Aluminum, and Thin-Walled Steel Tubing
- Ideal for Water, Gas, Refrigeration, and Brake Line Applications

Item	Description	Packaging	Cs	In
6483	Flaring Tool Set	Slide Blister Card	36	6



10-pc. Double Flaring Tool Set

- Precision-Machined Steel Die Bar and Double Flare Adapters
- Drop Forged, Heat Treated Steel Yoke
- Hardened Center Screw with Sliding T-Bar Handle
- Produces 45° Flare Angle
- Use with Copper, Aluminum, and Thin-Walled Steel Tubing
- Ideal for Water, Gas, Refrigeration, and Brake Line Applications
- 7-pc. Double Flare Adapters: 3/16", 1/4", 5/16", 3/8", 7/16", 1/2", 5/8"
- 1-pc. 7-Position Die Bar: 3/16", 1/4", 5/16", 3/8", 7/16", 1/2", 5/8"
- 1-pc. Flaring Yoke
- 1-pc. Organizer Carry Case

Item	Description	Packaging	Cs	In
6490	10-pc. Double Flaring Tool Set	Color Box	24	1



Tubing Bender

- Rugged All-Steel Construction
- Durable Chrome Plated Finish
- Smoothly Bends Thin-Walled Copper, Brass, and Aluminum Tubing without Crimping
- Dual-End Design Fits 3/16", 1/4", and 3/8" O.D. Tubing

Item	Description	Packaging	Cs	In
6515	Tubing Bender	Slide Blister Card	100	10



Three-Size Tubing Bender

- Aluminum Alloy Construction with Durable Baked Enamel Finish
- Calibrated to Bend Angles up to 180°
- Smoothly Bends Copper, Brass, Aluminum, and Thin-Walled Steel Tubing without Crimping
- Three-Channel Design Fits 1/4", 5/16", and 3/8" O.D. Tubing
- Ideal for Water, Gas, Refrigeration, and Brake Line Applications

Item	Description	Packaging	Cs	In
6519	Three-Size Tubing Bender	Slide Blister Card	50	5



15' Drain and Pipe Snake

- Hardened and Tempered 3/16" (5mm) Flat Steel Tape
- Flexible Spring Tip
- Easy-Coil Storage Reel
- Clears Drain Lines in Showers, Bathtubs, and Kitchen, Bath and Utility Sinks

Item	Description	Packaging	Cs	In
8065	15' Drain and Pipe Snake	Hang Card	96	12

78 Files



5-pc. Jumbo Needle File Set

- Hardened and Tempered Alloy Steel Construction
- Precision-Milled Cutting Teeth
- Textured Non-Slip Poly Handles
- 7" Overall Length

- 1-pc. Tapered Round
- 1-pc. Tapered Triangle
- 1-pc. Tapered Square
- 1-pc. Warding
- 1-pc. Equaling

Item	Description	Packaging	Cs	In
6652	5-pc. Jumbo Needle File Set	Slide Blister Card	100	10



10-pc. Needle File Set

- Hardened and Tempered Alloy Steel Construction
- Precision-Milled Cutting Teeth
- Comfortable Cushioned Non-Slip Handle Grip
- 5-1/2" Overall Length

- 1-pc. Oval
- 1-pc. Round
- 1-pc. Knife
- 1-pc. Half-Round
- 1-pc. Three Square
- 1-pc. Barrette
- 1-pc. Warding
- 1-pc. Equaling
- 1-pc. Square
- 1-pc. Crossing

Item	Description	Packaging	Cs	In
6655	10-pc. Needle File Set	Slide Blister Card	100	10



12-pc. File Set

- Complete Assortment of the Most Popular File Types and Sizes
- Multi-Purpose Files for Wood, Metal, and Polymers
- Hardened and Tempered Alloy Steel Construction
- Precision-Milled Cutting Teeth
- Oversized Contoured Poly Handles for a Sure, Comfortable Grip

- 1-pc. 10" Mill File
- 5-pc. 8" Files: Half-Round, Mill, Half-Round Wood Rasp, Round Wood Rasp, Flat
- 4-pc. 6" Files: 4-Way Shoe Rasp, Slim Taper, Extra Slim Taper, Round File
- 2-pc. Universal Poly Handles

Item	Description	Packaging	Cs	In
6665	12-pc. File Set	Color Box	20	1



2-pc. 8" Chainsaw Files

- Hardened and Tempered Tool Steel Construction
- Precision Machined Cutting Teeth
- 2-pc. Chainsaw Files: 3/16" x 8" and 7/32" x 8"

Item	Description	Packaging	Cs	In
6697	2-pc. 8" Chainsaw Files	Slide Blister Card	72	6



5-pc. 8" File Set

- Hardened and Tempered Carbon Steel
- Precision-Milled Cutting Teeth
- Oversized Comfortable Contoured Handles
- Sharpens, Shapes, and De-Burrs Metals and Polymers
- 8" Files, 12" Overall Length

- 1-pc. Flat
- 1-pc. Half Round
- 1-pc. Round
- 1-pc. Square
- 1-pc. Triangular

Item	Description	Packaging	Cs	In
66631	5-pc. 8" File Set	Sealed Blister	20	10

- Hardened and Tempered Tool Steel Construction
- Large Contoured Poly Handle for a Comfortable, Non-Slip Grip

Item	Description	Packaging	Cs	In
6676	8" Flat File	Wrap or Tie Card	72	6
6677	10" Flat File	Wrap or Tie Card	48	6
6678	12" Flat File	Wrap or Tie Card	48	6
6679	8" Half Round File	Wrap or Tie Card	72	4
6680	10" Half Round File	Wrap or Tie Card	48	6
6681	12" Half Round File	Wrap or Tie Card	48	6
6682	6" Tapered Round File	Wrap or Tie Card	72	6
6683	8" Tapered Round File	Wrap or Tie Card	72	6
6684	10" Tapered Round File	Wrap or Tie Card	48	6
6686	6" Mill File	Wrap or Tie Card	72	4
6687	8" Mill File	Wrap or Tie Card	72	4
6688	10" Mill File	Wrap or Tie Card	48	4
6689	12" Mill File	Wrap or Tie Card	48	6
6690	6" Triangular Saw File, Regular Taper	Wrap or Tie Card	72	6
6691	6" Triangular Saw File, Slim Taper	Wrap or Tie Card	72	6
6692	6" Triangular Saw File, Extra Slim Taper	Wrap or Tie Card	72	6
6693	8" Triangular Saw File, Regular Taper	Wrap or Tie Card	72	6
6694	8" Half Round Wood Rasp	Wrap or Tie Card	72	6
6695	10" Half Round Wood Rasp	Wrap or Tie Card	48	6
6696	8" 4-Way Shoe Rasp File	Slide Blister Card	72	6

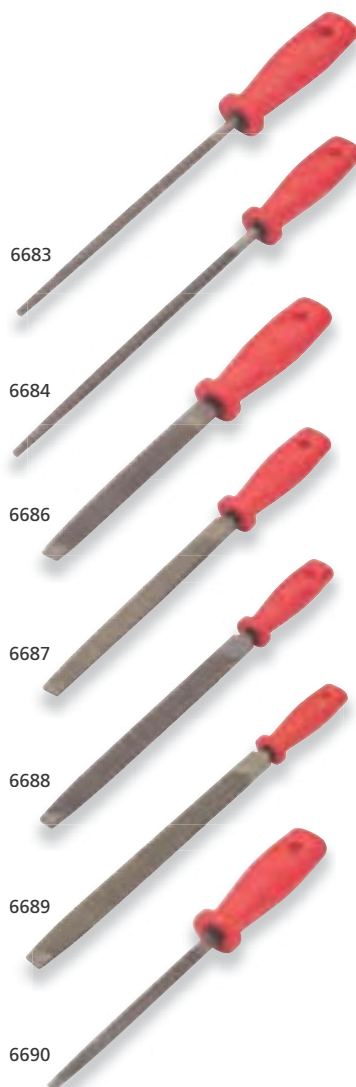

80 Punches and Chisels



4-pc. Nail Sets

- Hardened and Tempered Carbon Steel
 - Cushioned Rubberized Finger Grips for Non-Slip Handling
 - Tapered Striking Head Reduces Spalling
 - Precision-Machined Punch Tips
 - Sets Nail Heads Below Wood Surface for a Smooth, Finished Look
- 4-pc. Nail Sets: 1/32", 1/16", 3/32", 1/8"

Item	Description	Packaging	Cs	In
6574	4-pc. Nail Sets	Slide Blister Card	72	6



3-pc. Nail Sets

- Precision-Machined Hardened Steel
 - Knurled Shaft for Non-Slip Grip
 - Tapered Square Striking Head Reduces Spalling
 - Sets Nail Heads Below Wood Surface for a Smooth, Finished Look
- 3-pc. Nail Sets: 1/32", 1/16", 3/32"

Item	Description	Packaging	Cs	In
6578	3-pc. Nail Sets	Slide Blister Card	144	6



Automatic Center Punch

- Delivers an Automatic, High-Impact, Spring-Loaded Strike when Pressed Against Surface
- Adjustable Cap Regulates Striking Force
- Marks Hole Locations and Starts Drill Bits and Screws, Preventing Wandering
- Heat Treated Alloy Steel Punch with Sharp Precision Tip
- Corrosion-Resistant Brass Body with Non-Slip Knurled Grip
- Use on Wood, Metal, and Plastics
- 5-1/4" Overall Length

Item	Description	Packaging	Cs	In
6580	Automatic Center Punch	Slide Blister Card	252	12



4" Scratch Awl

- Hardened and Tempered Carbon Steel Shaft
- Corrosion-Resistant Chrome Plated Finish
- Contoured Natural Hardwood Handle
- Ultra-Fine Point Starts Pilot Holes, Punches Through-Holes, and Scribes Hard Surfaces

Item	Description	Packaging	Cs	In
6621	4" Scratch Awl	Slide Blister Card	240	12



28-pc. Transfer Punch Set

- Eliminates Guesswork when Transferring Threaded, Drilled, or Reamed Holes in Sheet Metal
- Hardened and Tempered Tool Steel Construction
- Black Oxide Finish for Durability
- 27-pc. Transfer Punch Sizes: 3/32" to 1/2" by 1/64th Increments
- 1-pc. 17/32" Punch
- 1-pc. Index Stand

Item	Description	Packaging	Cs	In
7319	28-pc. Transfer Punch Set	Color Box	12	1



Leather Punch

- Tempered Steel Punches
- Solid Brass Anvil
- Durable Chrome Plated Finish
- Comfortable Non-Slip Handle Grips
- Revolving Head for Quick Size Selection
- Punch Sizes: 3/32", 7/64", 1/8", 5/32", 11/64", 3/16"
- Punches Leather, Gaskets, Paper, Plastic, Vinyl, Cloth, and more

Item	Description	Packaging	Cs	In
6585	Leather Punch	Slide Blister Card	72	6



36-pc. 5/32" Letter and Number Stamp Set

- Hardened Chrome Vanadium Steel Punches
- Corrosion-Resistant Black Oxide Finish
- Includes A - Z and 0 - 9 Characters
- Imprints Metal, Wood, Plastic and Leather
- Length: 2-3/8"
- Width: 1/4"
- Character Height: 5/32"
- 36-pc. Punches: A - Z and 0 - 9
- Wood Index Box

Item	Description	Packaging	Cs	In
6610	36-pc. 5/32" Letter and Number Stamp Set	Color Box	24	6

36-pc. 5/16" Letter and Number Stamp Set

- Hardened Chrome Vanadium Steel Punches
- Corrosion-Resistant Black Oxide Finish
- Includes A - Z and 0 - 9 Characters
- Imprints Metal, Wood, Plastic and Leather
- Length: 2-1/2"
- Width: 3/8"
- Character Height: 5/16"
- 36-pc. Punches: A - Z and 0 - 9
- Wood Index Box

Item	Description	Packaging	Cs	In
6611	36-pc. 5/16" Letter and Number Stamp Set	Color Box	12	6

82 Punches and Chisels



6-pc. Hollow Punch Set

- Heat Treated Carbon Steel Construction
- Precision Ground Flute and Cutting Edge
- Non-Slip Knurled Handle Grip
- Cuts Clean Holes in Gaskets, Leather, Rubber, Cardboard, and Other Soft Materials
- 6-pc. Hollow Punches: 1/8", 5/32", 3/16", 7/32", 1/4", 5/16"

Item	Description	Packaging	Cs	In
6586	6-pc. Hollow Punch Set	Sealed Blister	72	6



9-pc. Hollow Punch Set

- Heat Treated Carbon Steel Construction
- Precision Ground Flute and Cutting Edge
- Non-Slip Knurled Handle Grip
- Cuts Clean Holes in Gaskets, Leather, Rubber, Cardboard, and Other Soft Materials
- 9-pc. Hollow Punches: 3/32", 1/8", 5/32", 3/16", 1/4", 5/16", 3/8", 7/16", 1/2"
- Complete with Organizer Storage Pouch

Item	Description	Packaging	Cs	In
6587	9-pc. Hollow Punch Set	Pouch/Color Label	48	6



12-pc. Hollow Punch Set

- Heat Treated Carbon Steel Construction
- Precision Ground Flute and Cutting Edge
- Non-Slip Knurled Handle Grip
- Cuts Clean Holes in Gaskets, Leather, Rubber, Cardboard, and Other Soft Materials
- 12-pc. Hollow Punches: 1/8", 5/32", 3/16", 7/32", 1/4", 5/16", 3/8", 7/16", 1/2", 9/16", 5/8", 3/4"
- Complete with Organizer Storage Pouch

Item	Description	Packaging	Cs	In
6588	12-pc. Hollow Punch Set	Pouch/Color Label	20	5



4-pc. Extra Long Taper Punch Set

- Machined from High Carbon Hex Stock Steel
- Precision Ground and Polished Tapered Tips
- Black Oxide Finish Resists Corrosion
- 4-pc. Long Tapered Punches 3/16" x 8" Tapered Punch 3/16" x 12" Tapered Punch 1/4" x 12" Tapered Punch 1/4" x 14-3/4" Tapered Punch

Item	Description	Packaging	Cs	In
6737	4-pc. Extra Long Taper Punch Set	Sealed Blister	16	4



12-pc. Cold Chisel and Punch Set

- Forged and Hardened Carbon Steel Construction
- Precision Ground and Polished Blades
- Heavy Duty Hex Stock Shanks
- Durable Baked Enamel Finish
- 6-pc. Cold Chisels: 1/2" x 7", 5/8" x 7", 3/4" x 8", 7/8" x 8", 7/8" x 10", 1" x 10"
- 1-pc. Pin Punch: 3/8" x 8"
- 3-pc. Tapered Punches: 1/8" x 6", 3/16" x 10", 3/8" x 10"
- 2-pc. Tapered Center Punches: 1/8" x 6", 1/4" x 8"
- Complete with Roll-up Storage Pouch

Item	Description	Packaging	Cs	In
6738	12-pc. Cold Chisel and Punch Set	Color Box	8	1



6-pc. Pin Punch Set

- Machined from Heat Treated Hex Stock Alloy Steel
- Precision Ground and Polished
- Tapered Striking Head Reduces Spalling
- 6-pc. Pin Punches: 3/32" x 4-1/4", 1/8" x 4-3/4", 5/32" x 5", 3/16" x 5-1/4", 1/4" x 5-3/4", 5/16" x 6-1/4"

Item	Description	Packaging	Cs	In
6739	6-pc. Pin Punch Set	Slide Blister Card	36	6



16-pc. Punch and Chisel Set

- Machined from Heat Treated Hex Stock Alloy Steel
- Precision Ground and Polished
- Tapered Striking Head Reduces Spalling
- 3-pc. Cold Chisels: 3/8" x 5-1/2", 1/2" x 6", 5/8" x 6-1/2"
- 2-pc. Center Punches: 1/8" x 5", 3/16" x 6"
- 5-pc. Taper Punches: 3/32" x 5-1/4", 1/8" x 4-3/4", 5/32" x 5", 3/16" x 5-1/4", 1/4" x 5-3/4"
- 5-pc. Pin Punches: 3/32" x 4-1/4", 1/8" x 4-3/4", 5/32" x 5", 3/16" x 5-1/4", 1/4" x 5-3/4"
- 1-pc. Chisel Punch Gauge

Item	Description	Packaging	Cs	In
6740	16-pc. Punch and Chisel Set	Sealed Blister	20	5

84 Individual Punches and Chisels

Item	Description	Packaging	Cs	In
6716	1/4" Cold Chisel	Slide Blister Card	36	6
6717	3/8" Cold Chisel	Slide Blister Card	36	6
6718	1/2" Cold Chisel	Slide Blister Card	36	6
6719	5/8" Cold Chisel	Slide Blister Card	36	6
6720	3/4" Cold Chisel	Slide Blister Card	36	6
6721	7/8" Cold Chisel	Slide Blister Card	36	6
6722	3/32" Pin Punch	Slide Blister Card	36	6
6723	1/8" Pin Punch	Slide Blister Card	36	6
6724	3/16" Pin Punch	Slide Blister Card	36	6
6726	1/4" Pin Punch	Slide Blister Card	36	6
6727	1/8" Taper Punch	Slide Blister Card	36	6
6728	3/16" Taper Punch	Slide Blister Card	36	6
6729	1/8" Center Punch	Slide Blister Card	36	6
6730	3/16" Center Punch	Slide Blister Card	36	6
6731	3/32" Center Punch	Slide Blister Card	36	6

- Precision Ground and Polished Blade
- Machined from High Carbon Hex Stock Steel
- Cushioned Grip Reduces Vibration Fatigue
- Tapered Striking Head Reduces Spalling

PACKAGING

- Fully enclosed slide blister packaging protects product and prevents contact with sharp edges.



7-pc. Punch and Chisel Set

- Precision Ground and Polished Blades and Punch Tips
- Machined from High Carbon Hex Stock Steel
- Cushioned Grip Reduces Vibration Fatigue
- Tapered Striking Head Reduces Spalling
- 6" Length
- 2-pc. Taper Punches: 1/8", 3/16"
- 1-pc. Pin Punch: 3/16"
- 1-pc. Center Punch: 3/8"
- 3-pc. Cold Chisels: 3/8", 1/2", 5/8"

Item	Description	Packaging	Cs	In
6725	7-pc. Punch and Chisel Set	Sealed Blister	40	5

- Drop Forged, Heat Treated Alloy Steel
- Precision-Machined Blade and Beveled Cutting Edge
- Lacquer Coating Protects and Lubricates Blade for Smooth Cutting
- Contoured, High-Impact Handle

Item	Description	Packaging	Cs	In
6751	1/4" Wood Chisel	Slide Blister Card	36	6
6752	3/8" Wood Chisel	Slide Blister Card	36	6
6753	1/2" Wood Chisel	Slide Blister Card	36	6
6754	3/4" Wood Chisel	Slide Blister Card	36	6
6755	1" Wood Chisel	Slide Blister Card	36	6
6756	1-1/4" Wood Chisel	Slide Blister Card	36	6
6757	1-1/2" Wood Chisel	Slide Blister Card	36	6



PACKAGING

- Fully enclosed slide blister packaging protects product and prevents contact with sharp edges.



4-pc. Wood Chisel Set

- Drop Forged, Heat Treated Steel
 - Precision-Machined Blade and Beveled Cutting Edge
 - Lacquer Coating Protects and Lubricates Blade for Smooth Cutting
 - Full-Size High-Impact Handle
- 4-pc. Wood Chisels: 1/4", 1/2", 3/4", 1"

Item	Description	Packaging	Cs	In
6758	4-pc. Wood Chisel Set	Slide Blister Card	40	5

3-pc. Wood Chisel Set

- Drop Forged, Heat Treated Alloy Steel
 - Precision-Machined Blade and Beveled Cutting Edge
 - Lacquer Coating Protects and Lubricates Blade for Smooth Cutting
 - Contoured, High-Impact Handle
- 3-pc. Wood Chisels: 1/2", 3/4", 1"

Item	Description	Packaging	Cs	In
6749	3-pc. Wood Chisel Set	Sealed Blister	18	6



Heavy Duty Close Quarter Hacksaw

- Tough Polypropylene Handle Construction
- Adjusts Blade Length to Fit into Tight Work Areas
- Knurled Steel Thumbscrew Locks Blade Position
- Accepts any Length Hacksaw Blade
- Includes Two 12" (18 TPI) High Carbon Steel Blades

Item	Description	Packaging	Cs	In
6798	Heavy Duty Close Quarter Hacksaw	Hang Card	120	12



6" Junior Hacksaw

- Compact, Light Duty Hacksaw for Tight Work Areas and Small Projects
- One-Piece Chrome Plated Steel Frame
- Includes Six 6" (24 TPI) Blades

Item	Description	Packaging	Cs	In
6801	6" Junior Hacksaw	Hang Card	120	12



6" Junior Coping Hacksaw

- Compact, Light Duty Hacksaw for Tight Work Areas and Small Projects
- One-Piece High-Impact ABS Frame
- Lever-Type Blade Receiver Applies Higher Tension
- Includes One 6" (24 TPI) Metal Cutting Blade and One 6" (24 TPI) Wood Cutting Blade

Item	Description	Packaging	Cs	In
6803	6" Junior Coping Hacksaw	Slide Blister Card	72	6



Adjustable Hacksaw

- Rugged All-Steel Construction
- Corrosion-Resistant Triple Chrome Plated Finish
- Comfortable Pistol-Grip Handle
- Wingnut Blade Tensioner
- Adjustable Frame Accepts 8", 10", or 12" Blades
- Includes 12" (24 TPI) Carbon Steel Blade

Item	Description	Packaging	Cs	In
6815	Adjustable Hacksaw	Color Label	36	6



Adjustable Hacksaw

- Rugged All-Steel Construction
- Corrosion-Resistant Triple Chrome Plated Finish
- Comfortable Non-Slip Cushioned Handle Grip
- Wingnut Blade Tensioner
- Adjustable Frame Accepts 8", 10", or 12" Blades
- Includes 12" (24 TPI) Carbon Steel Blade

Item	Description	Packaging	Cs	In
6816	Adjustable Hacksaw	Color Label	36	6



4-in-1 Deluxe Hacksaw Set

- Three-Position Adjustable Steel Frame Fits 8", 10", and 12" Blades
- Triple Chrome Plated Finish Resists Corrosion
- Non-Slip Cushioned Handle Grip
- Compact Close Quarters Handle Holds Blade at Any Length to Fit into Tight Work Areas
- Includes One Dual-Edge (18 TPI / 24 TPI) High Carbon Steel Blade

Item	Description	Packaging	Cs	In
6817	4-in-1 Deluxe Hacksaw Set	Wrap or Tie Card	36	6



High-Tension Angle Hacksaw

- Rugged Cast Aluminum Alloy Frame with Comfortable Non-Slip Handle Grip
- Rigid Square Tubular Steel Main Beam Prevents Twisting
- On-Board Blade Storage Compartment in Main Beam
- Adjust Blade Tension up to 400 lb.
- Two Blade Positions: 0° Normal Cut, 40° Flush Cut
- Includes One 12" (18 TPI) Flexible Bi-Metal Blade

Item	Description	Packaging	Cs	In
6823	High-Tension Angle Hacksaw	Color Sleeve	36	6



15" Tool Box Saw

- Contractor Grade Heavy Gauge Steel Blade
- Aggressive, Fully Sharpened Teeth Cut Faster
- Induction Hardened Teeth Stay Sharp Longer
- Soft, Comfortable, Non-Slip Finger Grip Handle Reduces Fatigue
- Compact 18" Overall Size for Easy Tool Box Storage
- 8 Teeth per Inch

Item	Description	Packaging	Cs	In
6852	15" Tool Box Saw	Color Sleeve	72	6



6" Cushion Grip Wallboard Saw

- Tempered 6" Heavy Duty Steel Blade
- Oversized, Non-Slip, Cushion Grip Handle
- Aggressive Offset Teeth for Quick, Accurate Cuts
- Sharpened Tip Punches Directly Through Drywall to Start Cut

Item	Description	Packaging	Cs	In
6861	6" Cushion Grip Wallboard Saw	Hang Card	72	6



6" Wallboard Saw

- Tempered 6" Steel Blade
- Comfortable Contoured Hardwood Handle
- Aggressive Offset Teeth for Quick, Accurate Cuts
- Sharpened Tip Punches Directly Through Drywall to Start Cut

Item	Description	Packaging	Cs	In
6862	6" Wallboard Saw	Hang Card	100	10



6-3/4" Coping Saw

- Nickel Plated Steel Frame Construction
- Contoured Wood Handle for a Comfortable Grip
- Hardened and Tempered, High-Carbon Steel Blades
- 6-3/4" Pin-End Blades Adjust for Angled Cuts

5-pc. 6" High-Carbon Steel Blades

- 2-pc. Medium (for Wood)
- 1-pc. Fine (for Thick Metal and Hardwood)
- 1-pc. Extra Fine (for Thin Metal and Thin Wood)
- 1-pc. Hacksaw Blade (All Metals)

Item	Description	Packaging	Cs	In
6865	6-3/4" Coping Saw	Wrap or Tie Card	72	6



12" Deluxe Bow Hacksaw

- Rugged Tubular Steel Frame with Durable Baked Enamel Finish
- Quick-Release Locking Cam Handle Allows Fast Blade Changes and Applies Higher Blade Tension
- Steel Handle Guard Helps Protect Fingers from Branches, Thorns and Other Debris while Cutting
- Includes Two Blades: Deep-Tooth, File Sharpened Wood Blade and 12" (18 TPI) Hacksaw Blade

Item	Description	Packaging	Cs	In
7914	12" Deluxe Bow Hacksaw	Color Sleeve	24	6

6-pc. 12" Hacksaw Blade Set

- Two Blades Each of 18, 24, and 32 Teeth per Inch
- Hardened and Tempered High-Carbon Steel
- Universal Replacement Blades for 12" Hacksaw Frames

Item	Description	Packaging	Cs	In
6825	6-pc. 12" Hacksaw Blade Set	Plastic Hang Tab/Label	200	10



Carbon Steel Hacksaw Blades

6830

- 18 Teeth per Inch
- Hardened and Tempered High-Carbon Steel
- Universal Replacement Blades for 12" Hacksaw Frames

6831

- 24 Teeth per Inch
- Hardened and Tempered High-Carbon Steel
- Universal Replacement Blades for 12" Hacksaw Frames

Item	Description	Packaging	Cs	In
6830	10-pc. 12" x 18 TPI Hacksaw Blade	Color Sleeve	120	10
6831	10-pc. 12" x 24 TPI Hacksaw Blade	Color Sleeve	120	10



Bi-Metal Hacksaw Blades

6832

- 18 Teeth per Inch
- Professional Grade Bi-Metal Blades for Faster Cuts and Longer Life
- Universal Replacement Blades for 12" Hacksaw Frames

6833

- 24 Teeth per Inch
- Professional Grade Bi-Metal Blades for Faster Cuts and Longer Life
- Universal Replacement Blades for 12" Hacksaw Frames

6834

- 32 Teeth per Inch
- Professional Grade Bi-Metal Blades for Faster Cuts and Longer Life
- Universal Replacement Blades for 12" Hacksaw Frames

Item	Description	Packaging	Cs	In
6832	2-pc. 12" x 18 TPI Bi-Metal Hacksaw Blades	Slide Blister Card	72	6
6833	2-pc. 12" x 24 TPI Bi-Metal Hacksaw Blades	Slide Blister Card	72	6
6834	2-pc. 12" x 32 TPI Bi-Metal Hacksaw Blades	Slide Blister Card	72	6





5-pc. Jigsaw Blade Set

- Tempered High-Carbon Steel Blades
- Universal Shank Fits Most Saws
- Color Coded Blade Types
- 5-pc. Jigsaw Blades:
 - 3" x 8 TPI (Yellow): Wood
 - 3" x 10 TPI (Orange): Wood, Plywood
 - 3" x 12 TPI (Violet): Plywood
 - 3" x 14 TPI (Green): Plywood, Paneling
 - 2" x 24 TPI (Red): Metal

Item	Description	Packaging	Cs	In
6885	5-pc. Jigsaw Blade Set	Slide Blister Card	144	12



8-pc. Jigsaw Blade Set

- Tempered High-Carbon Steel Blades
- Universal Shank Fits Most Saws
- Color Coded Blade Types
- 8-pc. Jigsaw Blades:
 - 5" x 8 TPI (Blue): Thick Wood
 - 2-1/2" x 8 TPI (Blue): Flush Cut Wood
 - 3" x 8 TPI (Yellow): Wood
 - 3" x 10 TPI (Violet): Wood, Plywood
 - 3" x 12TPI (Green): Plywood, Paneling
 - 2-1/2" x 14TPI (Orange): Scroll Cut
 - 2" x 24 TPI (Red): Metal
 - 3" Knife (Black): Leather, Canvas

Item	Description	Packaging	Cs	In
6890	8-pc. Jigsaw Blade Set	Slide Blister Card	144	12



10-pc. Reciprocating Saw Blades

- Longer Lasting Bi-Metal Blades for Sheet Metal, Re-bar, and Pipes
- Rugged Tempered High-Carbon Steel Blades for Wood and General Purpose Demolition
- Standard Duty .040" Thick Blades
- 4-pc. 6" (6TPI) Wood/Demolition Blades
- 2-pc. 6" (10TPI) Wood Blades
- 2-pc. 6" (18TPI) Metal Blades
- 2-pc. 8" (6TPI) Wood/Demolition Blades

Item	Description	Packaging	Cs	In
6892	10-pc. Reciprocating Saw Blades	Sealed Blister	40	5



14-pc. Reciprocating Saw Blade Kit

- Longer Lasting Bi-Metal Blades for Sheet Metal, Re-bar, and Pipes
- Rugged Tempered High-Carbon Steel Blades for Wood and General Purpose Demolition
- Standard Duty .040" Thick Blades
- 2-pc. 4" (14TPI) Metal Blades
- 2-pc. 4" (24TPI) Metal Blades
- 2-pc. 6" (18TPI) Masonite®/Metal Blades
- 2-pc. 6" (7TPI) Wood/Demolition Blades
- 2-pc. 8" (7TPI) Wood/Demolition Blades
- 2-pc. 9" (6TPI) Wood/Demolition Blades
- 2-pc. 12" (6TPI) Wood/Demolition Blades
- Complete with Roll-Up Storage Pouch

Item	Description	Packaging	Cs	In
6893	14-pc. Reciprocating Saw Blade Kit	Sealed Blister	40	4

Snap-Off Knife Blade Refills

6902

- 12-Point Tempered Spring Steel Blades
- Universal Snap-Off Knife Replacement Blades
- Complete with Storage Case

6903

- 8-Point Tempered Spring Steel Blades
- Universal Snap-Off Knife Replacement Blades
- Complete with Storage Case



Item	Description	Packaging	Cs	In
6902	10-pc. Compact Snap-Off Knife Blade Refills	Slide Blister Card	288	12
6903	10-pc. Snap-Off Knife Blade Refills	Slide Blister Card	288	12

Compact Snap-Off Knives

- Impact-Resistant ABS Housing
- Tempered Spring Steel Blade
- Snap Off Used Blades for a New Cutting Edge
- Fully Retractable Blade Locks in any Position
- Accepts Universal Replacement Blades

6905

- 60-pc. Small Snap-Off Knife Display (30-pc. Red, 30-pc. Black)

- AVAILABLE IN DISPLAY QUANTITIES ONLY



Item	Description	Packaging	Cs	In
6905	Compact Snap-Off Knife	UPC Label/Display Box	1200	60
96900	Compact Snap-Off Knife	Slide Blister Card	288	12

Snap-Off Knives

- Impact-Resistant ABS Housing
- Tempered Spring Steel Blade
- Snap Off Used Blades for a New Cutting Edge
- Fully Retractable Blade Locks in any Position
- Accepts Universal Replacement Blades

6912

- 24-pc. Large Snap-Off Knife Display (12-pc. Red, 12-pc. Black)

- AVAILABLE IN DISPLAY QUANTITIES ONLY



Item	Description	Packaging	Cs	In
6912	Snap-Off Knife	UPC Label/Display Box	480	24
96910	Snap-Off Knife	Slide Blister Card	288	12

3-pc. Snap-Off Knife Set

- Impact-Resistant ABS Housing
- Tempered Spring Steel Blade
- Snap Off Used Blades for a New Cutting Edge
- Fully Retractable Blade Locks in any Position
- Accepts Universal Replacement Blades

- 1-pc. Large Snap-Off Knife
- 2-pc. Small Snap-Off Knife



Item	Description	Packaging	Cs	In
96907	3-pc. Snap-Off Knife Set	Slide Blister Card	144	12

8-pc. Snap-Off Knife and Scraper Set

- All-Purpose Assortment of Utility Knives, Scrapers, and Cutters
- Ideal for Household, Garage, and Workplace Use

- 1-pc. Small Snap-Off Knife
- 1-pc. Large Snap-Off Knife
- 1-pc. Medium Snap-Off Knife
- 1-pc. Mini Snap-Off Knife
- 1-pc. Retractable Utility Knife
- 1-pc. Retractable Safety Scraper
- 1-pc. Utility Scraper
- 1-pc. Mini Box Cutter



Item	Description	Packaging	Cs	In
96909	8-pc. Snap-Off Knife and Scraper Set	Sealed Blister	120	12



Compact Auto-Load Snap-Off Utility Knife

- Tough ABS Housing with Steel Liner
- Full Non-Slip Rubber Grip
- Auto-Locking Retractable Blade
- Auto-Loading Instant Blade Change from On-Board 5-Blade Magazine
- Includes 5-pc. Replacement Blades

Item	Description	Packaging	Cs	In
6906	Compact Auto-Load Snap-Off Utility Knife	Slide Blister Card	96	8



Auto-Load Snap-Off Utility Knife

- Tough ABS Housing with Steel Liner
- Full Non-Slip Rubber Grip
- Auto-Locking Retractable Blade
- Auto-Loading Instant Blade Change from On-Board 5-Blade Magazine
- Includes 5-pc. Replacement Blades

Item	Description	Packaging	Cs	In
6913	Auto-Load Snap-Off Utility Knife	Slide Blister Card	96	4



Auto-Load Retractable Utility Knife

- Heavy Duty Metal Housing
- Non-Slip Rubber Grips
- Retractable Blade Locks in Three Cutting Positions
- Push Button Blade Release
- Auto-Loading Instant Blade Change from On-Board 5-Blade Magazine
- 1-pc. Utility Knife
- 3-pc. Blades

Item	Description	Packaging	Cs	In
6924	Auto-Load Retractable Utility Knife	Sealed Blister	64	8



Easy-Open Retractable Utility Knife

- Easy-Open, Heavy Duty, Zinc Alloy Housing for Fast Blade Replacement
- Non-Slip Rubber Handle Grips
- Fully Retractable Blade Adjusts to Three Cutting Positions
- Double Overlap Blade Guard
- Accepts Universal Replacement Utility Knife Blades
- 1-pc. Utility Knife
- 3-pc. Blades

Item	Description	Packaging	Cs	In
96914	Easy-Open Retractable Utility Knife	Hang Card	120	12



Retractable Utility Knives

- Rugged Aluminum Housing Weighs 50% Less than Standard Zinc Housing
 - Fully Retractable Blade Adjusts to Three Cutting Positions
 - Double Overlap Blade Guard
 - Accepts Universal Replacement Utility Knife Blades
- 1-pc. Utility Knife
 - 2-pc. Blades

Item	Description	Packaging	Cs	In
96915	Retractable Utility Knife	Hang Card	120	12
96917	Retractable Utility Knife	Hang Card	120	12



Heavy Duty Retractable Utility Knife

- Rugged Aluminum Housing Weighs 50% Less than Standard Zinc Housing
 - Fully Retractable Blade Adjusts to Eight Cutting Positions
 - Double Overlap Blade Guard
 - Accepts Universal Replacement Utility Knife Blades
- 1-pc. Utility Knife
 - 5-pc. Blades

Item	Description	Packaging	Cs	In
96916	Heavy Duty Retractable Utility Knife	Hang Card	72	6



2-pc. Quick-Change Folding Utility Knife Set

- Tough and Lightweight Aluminum Handles
- Push-Button Quick-Change Blade Release
- Compact Folding Lock-Back Design
- Easy One-Hand Opening

Item	Description	Packaging	Cs	In
6926	2-pc. Quick-Change Folding Utility Knife Set	Sealed Blister	48	6



2-in-1 Folding Sport Utility Knife

- Tough and Lightweight Aluminum Handles with Non-Slip Rubber Grips
- Easy One Hand Opening of Both Blades
- Rugged Nylon Belt Carry Case Included

UTILITY KNIFE

- Push Button Quick Blade Change
- Uses Universal Utility Replacement Blades

SPORT KNIFE

- 3" Combination Standard/Serrated Blade
- Rugged Stainless Steel Construction

- 1-pc. Folding Sport Utility Knife
- 1-pc. Utility Blade
- 1-pc. Belt Carry Case

Item	Description	Packaging	Cs	In
6930	2-in-1 Folding Sport Utility Knife	Sealed Blister	24	6

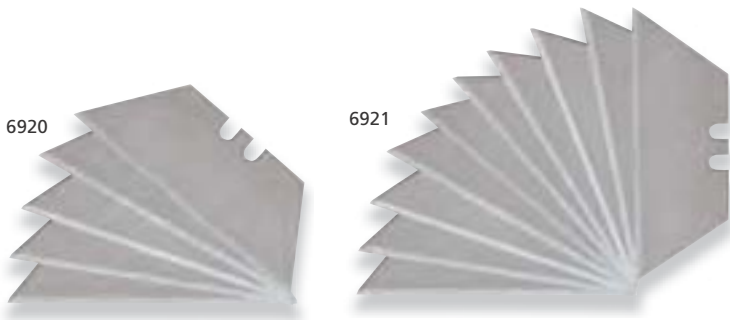

5-pc. Utility Knife Blades

- SK5 Spring Steel Standard Duty (0.50 mm) Utility Blades
- Universal Replacement Blades fit Most Utility Knives

Item	Description	Packaging	Cs	In
6920	5-pc. Utility Knife Blades	Slide Blister Card	1000	10
6921	10-pc. Utility Knife Blades	Slide Blister Card	500	10



5-pc. Hook Utility Knife Blades

- SK5 Spring Steel Standard Duty (0.50 mm) Hook-Style Blades
- Universal Replacement Blades fit Most Utility Knives

Item	Description	Packaging	Cs	In
6922	5-pc. Hook Utility Knife Blades	Slide Blister Card	500	10



100-pc. Utility Knife Blade Dispenser

- Compact and Convenient Storage Protects Blades
- Safely Dispenses Blades One at a Time
- Universal Replacement Blades fit Most Utility Knives
- 100-pc. Standard Duty (0.50mm) Utility Knife Blades

Item	Description	Packaging	Cs	In
82580	100-pc. Utility Knife Blade Dispenser	Slide Blister Card	48	6



10-in-1 Pocket Multi-Tool

- Rugged, Corrosion-Resistant Stainless Steel Construction
- Durable Anodized Aluminum Handle Scales
- Self-Opening Spring-Loaded Pliers Handles Reduce Fatigue
- Non-Slip Soft Handle Grips
- Folds to Compact Pocket Size

• 10 Tools in 1:

Pliers, Wire Cutters, Knife, Awl/Knife, 3mm Flat Screwdriver, 2mm Flat Screwdriver, Phillips Screwdriver, Flat File, Saw, Can/Bottle Opener

Item	Description	Packaging	Cs	In
7989	10-in-1 Pocket Multi-Tool	Sealed Blister	48	6



18" Machete with Sheath

- 18" High Carbon Steel Blade
- Durable Riveted Hardwood Handle
- Complete with Canvas Sheath
- 23" Overall Length

Item	Description	Packaging	Cs	In
7990	18" Machete with Sheath	Color Label	48	6



7" Linoleum Knife

- Tempered Steel Hooked Blade
- Precision-Ground Cutting Edge
- Contoured Natural Hardwood Handle
- Cuts Linoleum, Carpet, Vinyl, and Other Sheet Materials

Item	Description	Packaging	Cs	In
6925	7" Linoleum Knife	Slide Blister Card	72	6



Glass Cutter

- Die Cast Zinc Construction
- Carbide Steel Cutting Wheel
- Three Snap-Off Channels: 1/8", 5/32", and 3/16"

Item	Description	Packaging	Cs	In
6927	Glass Cutter	Slide Blister Card	144	12



Retractable Safety Scraper

- Durable Chrome Plated Finish
 - Fully Retractable Blade
 - SK5 Spring Steel Scraper Blades
 - Removes Paint, Adhesive, and Labels from Windows, Mirrors, and Tile
- 1-pc. Retractable Safety Scraper
 - 5-pc. Scraper Blades

Item	Description	Packaging	Cs	In
6935	Retractable Safety Scraper	Blister Card	144	12



Retractable Safety Scraper

- Lightweight and Durable ABS Housing
- Fully Retractable Blade
- SK5 Spring Steel Scraper Blades
- Removes Paint, Adhesive, and Labels from Windows, Mirrors, and Tile

Item	Description	Packaging	Cs	In
6938	Retractable Safety Scraper	Slide Blister Card	288	12



10-pc. Safety Scraper Blades

- SK5 Spring Steel Construction
- Universal Replacement Blades for all Safety Scrapers

Item	Description	Packaging	Cs	In
6940	10-pc. Safety Scraper Blades	Slide Blister Card	500	10



8-1/2" Household Scissors

- Hardened and Tempered Stainless Steel Blades
- Precision-Ground and Sharpened Cutting Edges
- Permanent Riveted Construction will not Loosen
- Comfortable Contoured Handles Reduce Fatigue

Item	Description	Packaging	Cs	In
8050	8-1/2" Household Scissors	Slide Blister Card	144	12



9-1/2" Multi-Purpose Scissors

- Multi-Purpose Serrated Stainless Steel Blades
- Non-Slip Pruning Hook Grips Small Branches for a Clean Cut
- Safety Lock Prevents Accidental Opening while Carrying or Storing
- Fully Enclosed Handle Protects Fingers
- Comfortable Non-Slip Grips Reduce Hand Fatigue

Item	Description	Packaging	Cs	In
8052	9-1/2" Multi-Purpose Scissors	Sealed Blister	64	4



• AVAILABLE IN DISPLAY QUANTITIES ONLY

4-pc. Scissors and Snap-Off Knife Set

9-1/2" Utility Scissors

- Multi-Purpose Serrated Stainless Steel Blades
- Non-Slip Pruning Hook Grips Small Branches for a Clean Cut
- Safety Lock Prevents Accidental Opening while Carrying or Storing
- Fully Enclosed Handle Protects Fingers
- Comfortable Non-Slip Grips Reduce Hand Fatigue

7-1/2" All-Purpose Scissors

- Stainless Steel Blades
- Comfortable Non-Slip Grips Reduce Hand Fatigue

6" Craft Scissors

- Stainless Steel Blades
- Comfortable Non-Slip Grips Reduce Hand Fatigue

Auto-Load Snap-Off Utility Knife

- Tough, Impact-Resistant Housing with Steel Liner
- Full Non-Slip Rubber Grip
- Auto-Locking Retractable Blade
- Auto-Loading Instant Blade Change from On-Board 5-Blade Magazine

Item	Description	Packaging	Cs	In
8054	4-pc. Scissors and Snap-Off Knife Set	Sealed Blister/Display Box	24	6



69271
69272



69274
69275
69276



69277



69278



69279



69281

Putty and Taping Knives

69271, 69274, 69275, 69277, 69278, 69279

- Full Tang, Double-Riveted Construction
- Durable Contoured Hardwood Handle
- Coated Steel Blade for Easy Clean-up and to Resist Rust and Corrosion
- Light Gauge (.020") Flexible Blade for Better Control

69272, 69276

- Full Tang, Double-Riveted Construction
- Durable Contoured Hardwood Handle
- Coated Steel Blade for Easy Clean-up and to Resist Rust and Corrosion
- Heavy Gauge (.040") Stiff Blade Applies More Pressure

69281

- Full Tang, Double-Riveted Construction
- Durable Contoured Hardwood Handle
- Coated Steel Blade for Easy Clean-up and to Resist Rust and Corrosion
- 2-1/2" Deep-Groove Comb Cleans Paint and Debris from any Paint Brush
- Roller Cleaner Scrapes Paint from Roller Cover Surface to Speed Cleaning

Item	Description	Packaging	Cs	In
69271	1-1/4" Putty Knife (Flex)	Color Label	144	12
69272	1-1/4" Putty Knife (Stiff)	Color Label	144	12
69274	2" Putty Knife (Flex)	Color Label	144	12
69275	3" Putty Knife (Flex)	Color Label	144	12
69276	3" Putty Knife (Stiff)	Color Label	144	12
69277	4" Taping Knife (Flex)	Color Label	144	12
69278	5" Taping Knife (Flex)	Color Label	144	12
69279	6" Taping Knife (Flex)	Color Label	144	12
69281	Brush and Roller Cleaner	Color Label	144	12



5-in-1 Painter's Tool

- Tempered High Carbon Steel Blade
- Polished, Lacquer-Coated Finish
- Full Tang Riveted Construction
- Five Tools in One: Paint Scraper, Putty Knife, Paint Can Opener, Crevice Cleaner, Roller Cleaner

Item	Description	Packaging	Cs	In
6928	5-in-1 Painter's Tool	Sealed Blister	144	12



5-pc. Paint Brush Set

- General Purpose Polyester Bristles for Use with Latex and Oil-Based Paints and Stains
- Use on Interior and Exterior Smooth to Semi-Rough Surfaces
- Comfortable Contoured Handles
- 5-pc. Brush Set: 1", 1-1/2", 2", 2-1/2", 3"

Item	Description	Packaging	Cs	In
7002	5-pc. Paint Brush Set	Poly Bag/Hang Card	60	10



Caulking Gun

- Rugged All-Steel, Easy-Load, Half-Barrel Design
- Quick-Release, Smooth Ratchet Advance for Consistent Material Application
- Retractable Seal Puncture Tool and Built-In Nozzle Cutter
- Accepts All Standard Size Tube Cartridges
- Use with Low Viscosity Latex, Vinyl, and Acrylic Caulks and Sealants

Item	Description	Packaging	Cs	In
7007	Caulking Gun	Color Label	36	6



Drip-Free Caulking Gun

- Rugged All-Steel, Side-Load, Open-Frame Design
- Automatic Drip-Free Ratchet Advance Eliminates Waste and Keeps Your Job Clean
- Hex Push Rod with Ladder Hook
- Retractable Seal Puncture Tool and Built-In Nozzle Cutter
- Accepts All Standard Size Tube Cartridges
- Use with Low to Medium Viscosity Latex, Vinyl, Acrylic, Siliconized Acrylic, and Silicone Caulks and Sealants

Item	Description	Packaging	Cs	In
7008	Drip-Free Caulking Gun	Color Label	36	6



Safety Goggles

- Lightweight and Durable Polycarbonate Lens
- Easily Fits over Prescription Eyewear
- Adjustable Elastic Headband
- Completely Vented to Prevent Fogging
- Provides Required Eye Protection for Many Hand and Power Tool Applications
- Meets or Exceeds ANSI Z87.1 Standards for Protective Eyewear

Item	Description	Packaging	Cs	In
6975	Safety Goggles	Poly Bag/Hang Card	200	10



Dust Masks

- Moldable Nosepiece for Comfortable Custom Fit
- Low Profile Design for Use with Safety Glasses
- Allows Easy Breathing and Speech
- Filters Dust, Pollen, Pet Dander, and Other Non-Toxic Particles

6980

- AVAILABLE IN DISPLAY QUANTITIES ONLY

Item	Description	Packaging	Cs	In
6980	50-pc. Dust Masks	UPC Label/Display Box	24	6
6981	5-pc. Dust Masks	Sealed Blister	72	12



Deluxe Knee Pads

- Tough Nylon Construction
- Hard Caps Protect Knees from Rough Surfaces
- Soft Contoured Padded Lining
- Comfortable Extra Wide Adjustable Elastic Straps
- Contractor-Grade
- One Size Fits All

Item	Description	Packaging	Cs	In
7023	Deluxe Knee Pads	Poly Bag/Hang Card	36	6



Ear Muff Hearing Protection

- Adjustable Headstrap for Custom Fit
- Large Comfortable Cushioned Ear Cups
- Lightweight, High-Impact ABS Construction
- Reduces Harmful Noise while Operating Lawn Mowers and String Trimmers, Circular Saws, and Other Power Tools
- Noise Reduction Rating (NRR): 20 dB

Item	Description	Packaging	Cs	In
6984	Ear Muff Hearing Protection	Poly Bag/Hang Card	72	6



Dust Filter Mask

- Flexible Padded Seal for Comfortable Custom Fit
- Wide Adjustable Elastic Headband
- Low Profile Design for Use with Safety Glasses
- Allows Easy Breathing and Speech
- Filters Dust, Pollen, Pet Dander, and Other Non-Toxic Particles

Item	Description	Packaging	Cs	In
6982	Dust Filter Mask	Slide Blister Card	144	12



300 ft. High-Visibility Safety Tape

- Weather-Resistant
- Non-Adhesive
- Tape Size: 3 in. (76 mm) x 300 ft. (91 m)

Item	Description	Packaging	Cs	In
7402	300 ft. High-Visibility Safety Tape	Color Label	24	4



100' Chalk Line Reel with Chalk

- Self-Chalking Cast Zinc Housing
- Housing Doubles as a Plumb Bob
- 1-1/2" Fold-Away Reel Crank Handle
- 100' Lightweight Braided Line
- Includes Chalk Refill Bottle

Item	Description	Packaging	Cs	In
7003	100' Chalk Line Reel with Chalk	Sealed Blister	24	6



100' Chalk Line Reel

- Self-Chalking Cast Zinc Housing
- Housing Doubles as a Plumb Bob
- 1-1/2" Fold-Away Reel Crank Handle
- 100' Lightweight Braided Line

Item	Description	Packaging	Cs	In
7005	100' Chalk Line Reel	Slide Blister Card	96	6

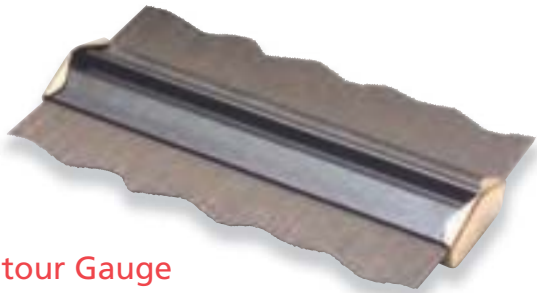

Contour Gauge

- Rugged Metal Body
- Corrosion-Resistant Stainless Steel Pins
- Die Stamped Inch Scale (1/16" Graduations) and Metric Scale (Millimeter Graduations)
- Quickly Duplicates Difficult or Intricate Shapes and Patterns

Item	Description	Packaging	Cs	In
7015	Contour Gauge	Slide Blister Card	36	6

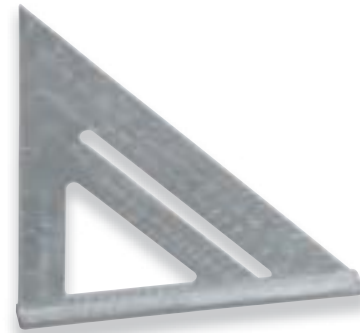

7" Aluminum Quick Square

- Rugged, Lightweight Aluminum
- Angle, Hip/Valley, Top/Common Cut, and Inch Markings
- Broad Foot Aligns Square and Slides Along Board Edge
- All-in-One Rafter Angle Square, Tri-Square, and Protractor
- Includes Rafter Layout and Reference Guide

Item	Description	Packaging	Cs	In
7135	7" Aluminum Quick Square	Slide Blister Card	96	12



8" x 12" Carpenter's Square

- Durable Steel Construction
- Black Baked Enamel Finish
- High Contrast White Markings
- 8" (1") x 12" (1-1/2")

Item	Description	Packaging	Cs	In
7140	8" x 12" Carpenter's Square	Hang Card	120	40



5-pc. Mini Level Set

- 3-Vial Magnetic Torpedo Level Attracts to Pipes and Metal Studs and Measures Plumb, Level, and 45-degrees
- 2-in-1 Pocket Level/Screwdriver Includes 1/4" Flat and #2 Phillips Bits
- Multi-Purpose Bull's Eye Level and "T"-Level for General Purpose Applications
- Line Level with Offset Hooks Attaches Securely to Mason's Line
- Compact Layout Tools for a Wide Range of Projects: Finish Carpentry, Plumbing, Landscaping, Workshop, and Assembly
- 1-pc. 9" Torpedo Level
- 1-pc. Pen Level/Screwdriver
- 1-pc. Bull's Eye Level
- 1-pc. "T"-Level
- 1-pc. Line Level

Item	Description	Packaging	Cs	In
71142	5-pc. Mini Level Set	Slide Blister Card	48	2



18" Triple Vial Level

- One-Piece Cast I-Beam Construction
- 3-Vial Design Measures Level, Plumb, and 45°
- Easy Read Dual Inch/Metric Measuring Scale

Item	Description	Packaging	Cs	In
71141	18" Triple Vial Level	Color Label	24	2

Fiberglass Tape Measures

- Rugged, Impact-Resistant ABS Reel Housing with Carry Handle
- Fiberglass-Core Tape with Durable Vinyl Coating
- Moisture Resistant Tape
- Inch and Metric Graduations
- Steel Crank Handle Locks Conveniently Out of Way
- Use for Landscaping, Building, Surveying, and Many Other Commercial and Industrial Applications

Item	Description	Packaging	Cs	In
7225	50' Fiberglass Tape Measure	Wrap or Tie Card	24	6
7230	100' Fiberglass Tape Measure	Wrap or Tie Card	24	4
7235	165' Fiberglass Tape Measure	Wrap or Tie Card	24	4
7240	300' Fiberglass Tape Measure	Wrap or Tie Card	12	3



6' Folding Ruler

- Wood Ruler with High-Contrast Black-on-Yellow Markings
- Compact 9" Folded Size
- Zinc Plated Folding Joints Lock Ruler into Position at 180°

Item	Description	Packaging	Cs	In
7245	6' Folding Ruler	Color Sleeve	240	12





6" Vernier Caliper

- Chrome Plated Steel Construction
- Reads 0-6" in 1/128" Graduations and 0-155mm in .05mm Graduations
- Jaws Measure Inside and Outside Dimensions
- Includes Depth Gauge
- Thumb Screw Locks Reading in Place
- Rolling Adjustment for Precise Jaw Positioning

Item	Description	Packaging	Cs	In
7159	6" Vernier Caliper	Slide Blister Card	144	12



6" Dial Calipers

- Reads 0-6" in 0.001" Graduations
- Hardened Satin Chrome Plated Steel
- Precision-Ground Jaws with Thumb Roll for Exact Positioning
- Slide Lock Holds Reading in Place
- Jaws Designed for Inside, Outside, and Thread Measurements
- Shock-Proof Dial Face with Micro-Fine Black Graduations for Precise Readings
- Complete with Plastic Storage Case

Item	Description	Packaging	Cs	In
7165	6" Dial Calipers	Bulk/UPC	50	5



0-1" Dial Indicator

- Reads 0-1" in 0.001" Graduations
- 2" Diameter Dial Face with Inset Revolution Counter
- Smooth Jeweled Movement for Precise Readings
- Hardened Steel Contact Point
- Universal Mount
- Can be Used with TEKTON® 7172 Magnetic Base

Item	Description	Packaging	Cs	In
7169	0-1" Dial Indicator	Sealed Blister	50	10



Magnetic Base For Dial Indicator

- 3-Lb. Weighted, Cast Steel Base with Built-in Magnet
- On/Off Switch Releases Magnet
- Fully Adjustable Two-Arm Design
- Precision-Adjustment Knob for Fine Positioning
- Accepts Many Dial Indicator Mounts
- Can be Used with TEKTON® 7169 Dial Indicator

Item	Description	Packaging	Cs	In
7172	Magnetic Base For Dial Indicator	White Box/Color Label	20	1



Tape Measures

- Rugged, Impact-Resistant ABS Housing with Non-Slip Cushioned Grip
- Posi-Lock Sliding Thumb Switch Locks Tape Securely in Position
- One-Touch Quick-Stop Button Pauses Tape at any Position
- Triple-Rivet Sliding End Hook for Accurate Inside and Outside Measurements
- Shock-Absorbing Bumper Guard Cushions Rewinding Tape Blade
- Durable Coated Blade Resists Corrosion
- Rapid Read™ Black-on-Yellow Blade Features:
 - Fractional Readout Every 1/8"
 - Stud Markings in Red Every 16"
 - 1/16" Graduations Throughout

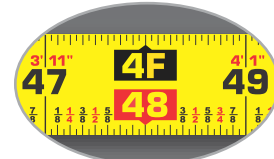

Item	Description	Packaging	Cs	In
71951	12' x 1/2" Tape Measure	Hang Card	72	6
71952	16' x 3/4" Tape Measure	Hang Card	72	6
71953	25' x 1" Tape Measure	Hang Card	36	4
71954	30' x 1" Tape Measure	Hang Card	36	4
71955	33' x 1" Tape Measure	Hang Card	36	4



12' x 1/2" Tape Measure

- Rugged, Impact-Resistant ABS Housing
- Triple-Rivet Sliding End Hook for Accurate Inside/Outside Measurements
- Easy-Read, Black-on-Yellow Tape with Corrosion-Resistant Coating
- 1/32" Graduations for First Foot, 1/16" Graduations Throughout
- Stud Markings in Red Every 16"

Item	Description	Packaging	Cs	In
7197	12' x 1/2" Tape Measure	Hang Card	72	12



25' x 1" Tape Measure

- Rugged, Impact-Resistant ABS Housing
- Durable Coated Blade Resists Corrosion
- Sliding Thumb Switch Locks Tape in Position
- 7' Blade Standout Length
- Triple-Rivet Sliding End Hook for Accurate Inside and Outside Measurements
- Rapid Read™ Black-on-Yellow Blade Features:
 - Fractional Readout Every 1/8"
 - Stud Markings in Red Every 16"
 - 1/32" Graduations (first foot), 1/16" Graduations Throughout

7213

- AVAILABLE IN DISPLAY QUANTITIES ONLY

Item	Description	Packaging	Cs	In
7213	25' x 1" Tape Measure	UPC Label/Display Box	36	12
7214	25' x 1" Tape Measure	Hang Card	36	6



6-pc. Quick Change Hex Shank HSS Drill Bit Set

- Hardened High Speed Steel Twist Drill Bits
- Precision Roll-Forged Flutes
- 135° Split Point Starts on Contact, Reduces Walking
- Universal Fit 1/4" Hex Shank for Quick-Change Chucks
- Multi-Purpose Bits for Wood, Metal and Plastic
- 6-pc. High Speed Steel Drill Bits: 1/16", 3/32", 1/8", 5/32", 3/16", 1/4"

Item	Description	Packaging	Cs	In
7281	6-pc. Quick Change Hex Shank HSS Drill Bit Set	Slide Blister Card	72	6



7-pc. Brad Point Drill Bit Set

- Self-Piloting Brad Point Tip Starts On Contact without Walking or Wandering
- Hardened and Tempered High-Carbon Steel Construction
- Precision-Machined, Polished Cutting Edges Reduce Friction
- 1/4" Reduced Shanks fit all Drills
- 7-pc. Brad Point Drill Bits: 1/8", 3/16", 1/4", 5/16", 3/8", 7/16", 1/2"

Item	Description	Packaging	Cs	In
7288	7-pc. Brad Point Drill Bit Set	Slide Blister Card	72	6



6-pc. Spade Bit Set

- High Carbon Steel Construction
- Grooved Spur Point for Exact Positioning and Quick Start
- Precision-Ground Edges Cut Faster and Cleaner
- Short Bit Length fits Between Joists, Studs, and into Other Tight Work Spaces
- Non-Slip Reduced Hex Shank Eliminates Twisting in Drill Chuck
- 6" Overall Length
- 6-pc. Drill Bits: 3/8", 1/2", 5/8", 3/4", 7/8", 1"

Item	Description	Packaging	Cs	In
7290	6-pc. Spade Bit Set	Slide Blister Card	60	6



5-pc. Masonry Drill Bit Set

- High Carbon Steel Construction
- 135° Carbide Cutting Tip
- Universal Fit 1/4" Shank
- Cuts Brick, Concrete, and Ceramic Tile
- 5-pc. Drill Bits: 3/16", 1/4", 5/16", 3/8", 1/2"
- Complete with Storage Case

Item	Description	Packaging	Cs	In
7293	5-pc. Masonry Drill Bit Set	Slide Blister Card	100	5

13-pc. Twist Drill Bit Set

- Carbon Steel Twist Drill Bits
 - Precision Roll-Forged Flutes
 - Use with all Power and Cordless Drills
 - Multi-Purpose Bits for Wood and Plastic
- 13-pc. Drill Bits: 1/16", 5/64", 3/32", 7/64", 1/8", 9/64", 5/32", 11/64", 3/16", 13/64", 7/32", 15/64", 1/4"
- Complete with Index Case



Item	Description	Packaging	Cs	In
7292	13-pc. Twist Drill Bit Set	Slide Blister Card	36	6

13-pc. High Speed Steel Drill Bit Sets

- 7295**
- Hardened and Tempered M2 High Speed Steel Construction
 - Polished Flutes Quickly Churn Debris Away From Work
 - 135° Split Point Starts on Contact, Reduces Walking
 - Multi-Purpose Bits for Wood, Plastic, and Metal
- 13-pc. Drill Bit: 1/16", 5/64", 3/32", 7/64", 1/8", 9/64", 5/32", 11/64", 3/16", 13/64", 7/32", 15/64", 1/4"
- Complete with Metal Index Case
- 7303**
- Hardened M2 High Speed Steel Twist Drill Bits
 - Titanium-Nitride Coating Resists Heat for Increased High Speed Performance
 - Polished, Precision Roll-Forged Flutes
 - 135° Split Point Starts on Contact, Reduces Walking
 - Multi-Purpose Bits for Wood, Metal and Plastic



7295

7303

Item	Description	Packaging	Cs	In
7295	13-pc. High Speed Steel Drill Bit Set	Color Label	60	5
7303	13-pc. Titanium High Speed Steel Drill Bit Set	Color Label	100	5

33-pc. High Speed Steel Drill Bit Sets

- 7302**
- Hardened M2 High Speed Steel Twist Drill Bits
 - Polished, Precision Roll-Forged Flutes
 - 135° Split Point Starts on Contact, Reduces Walking
 - 3/8" Reduced Shanks
 - Multi-Purpose Bits for Wood, Metal and Plastic
- 33-pc. Drill Bits: 1/16" (2pc.), 5/64" (2pc.), 3/32", 7/64", 1/8"(2pc.), 9/64", 5/32", 11/64", 3/16", 13/64", 7/32", 15/64", 1/4", 17/64", 9/32", 19/64", 5/16", 21/64", 11/32", 23/64", 3/8", 25/64", 13/32", 27/64", 7/16", 29/64", 15/32", 31/64", 1/2"
- Complete with Metal Index Case
- 7304**
- Hardened M2 High Speed Steel Twist Drill Bits
 - Titanium-Nitride Coating Resists Heat for Increased High Speed Performance
 - Polished, Precision Roll-Forged Flutes
 - 135° Split Point Starts on Contact, Reduces Walking
 - 3/8" Reduced Shanks
 - Multi-Purpose Bits for Wood, Metal and Plastic



7302

7304

Item	Description	Packaging	Cs	In
7302	33-pc. High Speed Steel Drill Bit Set	Color Label	12	6
7304	33-pc. Titanium High Speed Steel Drill Bit Set	Color Label	12	6

29-pc. High Speed Steel Drill Bit Set

- Hardened M2 High Speed Steel Twist Drill Bits
 - Precision Roll-Forged Flutes
 - 118° Point Starts on Contact, Reduces Walking
 - 3/8" Reduced Shanks
 - Multi-Purpose Bits for Wood, Metal and Plastic
- 29-pc. Drill Bits: 1/16", 5/64", 3/32", 7/64", 1/8", 9/64", 5/32", 11/64", 3/16", 13/64", 7/32", 15/64", 1/4", 17/64", 9/32", 19/64", 5/16", 21/64", 11/32", 23/64", 3/8", 25/64", 13/32", 27/64", 7/16", 29/64", 15/32", 31/64", 1/2"
- Complete with Metal Index Case



Item	Description	Packaging	Cs	In
7297	29-pc. High Speed Steel Drill Bit Set	Color Box	12	6

Rivet Gun with 40-pc. Rivets



- Rugged All-Steel Construction
- Durable Black Wrinkle Finish
- Non-Slip Cushioned Handle Grips
- Rivet Heads and Wrench Store in Handle
- Rust-Proof Aluminum Rivets
- Use for Sheet Metal, Automotive and Duct Work Applications

- 1-pc. Rivet Gun
- 10-pc. 3/32" x 1/4" Rivets
- 10-pc. 1/8" x 1/4" Rivets
- 10-pc. 5/32" x 1/4" Rivets
- 10-pc. 3/16" x 1/4" Rivets
- 4-pc. Rivet Heads
- 1-pc. Head Wrench

Item	Description	Packaging	Cs	In
6555	Rivet Gun with 40-pc. Rivets	Slide Blister Card	20	5

100-pc. Assorted Rivets



- Rust Proof Aluminum Heads with Steel Shanks
- Popular Size Blind Rivets Fit all Hand and Air Riveters, Foreign and Domestic

- 20-pc. 1/8" x 1/4"
- 30-pc. 1/8" x 5/16"
- 30-pc. 5/32" x 1/4"
- 20-pc. 3/16" x 5/16"

Item	Description	Packaging	Cs	In
6565	100-pc. Assorted Rivets	Slide Blister Card	36	6

45-pc. Tungsten Steel Tap and Die Sets

- Hardened Tungsten Alloy High Speed Steel
- Rust-Resistant Satin Finish
- Precision-Milled Threads Cut Raw Material or Repair Existing Threads



7560

- 1-pc. 1/4" T-Handle Tap Wrench
- 1-pc. 1/4" - 1" T-Handle Tap Wrench
- 1-pc. 2" (Dia.) T-Handle Die Stock
- 1-pc. 1-1/2" (Dia.) Die Stock Adapter
- 1-pc. Screwdriver
- 20-pc. Taps
- 20-pc. Split Dies
- Complete with Storage Case

Tap and Die Sizes:

- Coarse Threads (NC): 1/4 NC 20, 5/16 NC 18, 3/8 NC 16, 7/16 NC 14, 1/2 NC 13, 9/16 NC 12, 5/8 NC 11, 3/4 NC 10, 7/8 NC 9, 1 NC 8
- Fine Threads (NF): 1/4 NF 28, 5/16 NF 24, 3/8 NF 24, 7/16 NF 20, 1/2 NF 20, 9/16 NF 18, 5/8 NF 18, 3/4 NF 16, 7/8 NF 14, 1 NF 14

7561

- 1-pc. 1/4" T-Handle Tap Wrench
- 1-pc. 1/4" - 1" T-Handle Tap Wrench
- 1-pc. 2" (Dia.) T-Handle Die Stock
- 1-pc. 1-1/2" (Dia.) Die Stock Adapter
- 1-pc. Screwdriver
- 20-pc. Taps
- 20-pc. Split Dies
- Complete with Storage Case

Tap and Die Sizes:

- Coarse Threads (NC): 6 x 1.0, 8 x 1.25, 10 x 1.5, 12 x 1.75, 14 x 2.0, 16 x 2.0, 18 x 2.5, 20 x 2.5, 22 x 2.5, 24 x 3.0
- Fine Threads (NF): 6 x 0.75, 8 x 1.0, 10 x 1.25, 12 x 1.5, 14 x 1.5, 16 x 1.5, 18 x 1.5, 20 x 1.5, 22 x 1.5, 24 x 1.5

Item	Description	Packaging	Cs	In
7560	45-pc. Tap and Die Set (SAE)	Color Box	3	1
7561	45-pc. Tap and Die Set (Metric)	Color Box	3	1



9-pc. Ratchet Pipe Threader Kit

- Heat Treated High Carbon Steel Dies
- Precision-Milled Dies Cut New Material or Repair Existing Threads
- Reversible Ratchet-Drive Die Wrench
- 19" High-Torque Wrench Handle with Non-Slip Grip
- 5-pc. Pipe Thread Dies: 1/4" (18 TPI), 3/8" (18 TPI), 1/2" (14 TPI), 3/4" (14 TPI), 1" (11-1/2" TPI) NPT
- 1-pc. Ratchet Die Wrench
- 2-pc. 19" Wrench Handle
- 1-pc. Carry Case



Item	Description	Packaging	Cs	In
7574	9-pc. Ratchet Pipe Threader Kit	Color Box	2	1

5-pc. Screw Extractor Set

- Heat Treated High Carbon Steel Construction
- Corrosion-Resistant Finish
- Removes Broken Screws, Bolts, and Studs without Damaging Hole Threads
- 5-pc. Screw Extractors: 1/8"-1/4", 1/4"-5/16", 5/16"-7/16", 7/16"-9/16", 9/16"-3/4"
- Complete with Storage Case

Item	Description	Packaging	Cs	In
7576	5-pc. Screw Extractor Set	Blister Card	144	12



2-pc. Nut Splitter Set

- Cuts Off Rusted, Cross-Threaded or Rounded-Off Nuts without Damaging Bolt Threads
- Forged and Hardened Chrome Vanadium Steel Chisel for Long Life
- Rugged Forged and Heat Treated Carbon Steel Frame
- 1-pc. 1/2" - 5/8" (12-16mm) Nut Splitter, 9/16" Drive
- 1-pc. 5/8" - 7/8" (16-22mm) Nut Splitter, 3/4" Drive

Item	Description	Packaging	Cs	In
7580	2-pc. Nut Splitter Set	Sealed Blister	36	6



Claw Pick-Up Tools

7593

- 24" Flexible Spring Steel Shaft
- Spring-Loaded, 4-Prong Steel Claw
- Retrieves Small, Non-Ferrous Objects that Magnets Cannot

7597

- 36" Flexible Spring Steel Shaft
- Spring-Loaded, 4-Prong Steel Claw
- Retrieves Small, Non-Ferrous Objects that Magnets Cannot

Item	Description	Packaging	Cs	In
7593	24" Claw Pick-Up Tool	Hang Card	100	10
7597	36" Claw Pick-Up Tool	Hang Card	100	10

Telescoping Magnetic Pick-Up Tool

- Retrieves Ferrous Metal Objects up to 3 lb.
- Telescopes from 5-3/16" to 25"
- Chrome Plated Metal Shaft
- Durable Enamel-Coated Housing
- Pen Size Tool with Pocket Clip

Item	Description	Packaging	Cs	In
7601	Telescoping Magnetic Pick-Up Tool	Slide Blister Card	144	6

Telescoping Inspection Mirror

- 1-1/4" Diameter Mirror
- Telescopes from 6" to 19"
- Dual Ball Joint Positions Mirror at any Angle
- Pen Size Tool with Pocket Clip
- Durable Chrome Plated Finish

Item	Description	Packaging	Cs	In
7604	Telescoping Inspection Mirror	Slide Blister Card	240	12

Telescoping Pick-Up and Inspection Tools

7607

- Retrieves Ferrous Metal Objects up to 1/2 lb.
- Dual Ball Joint Positions Magnet at any Angle
- Telescopes from 11" to 17"
- Non-Slip Cushioned Handle Grip
- Durable Chrome Plated Finish

7608

- 2" Diameter Mirror
- Telescopes from 11" to 17"
- Dual Ball Joint Positions Mirror at any Angle
- Non-Slip Cushioned Handle Grip
- Durable Chrome Plated Finish

Item	Description	Packaging	Cs	In
7607	Telescoping Magnetic Pick-Up Tool	Slide Blister Card	72	12
7608	Telescoping Inspection Mirror	Slide Blister Card	72	12



Telescoping Lighted Inspection Mirror

- Large 1-1/2" x 2-1/2" Mirror
- Twin Bright White LEDs Illuminate Hidden Areas for Ultimate Visibility
- Dual Ball Joint Positions Mirror at any Angle
- Extends from 12" to 35"
- Corrosion-Resistant Chrome Plated Shaft
- Comfortable Molded Poly Handle with Soft, Non-Slip Rubber Grip
- Uses Two CR2032 Button Cell Batteries (Included)

Item	Description	Packaging	Cs	In
7609	Telescoping Lighted Inspection Mirror	Slide Blister Card	96	1

Telescoping Lighted Magnetic Pick-Up Tool

- Retrieves Ferrous Metal Objects up to 1-1/2 lb.
- Bright White LED Illuminates Hidden Areas for Ultimate Visibility
- Dual Ball Joint Positions Magnet at any Angle
- Extends from 9" to 30"
- Corrosion-Resistant Chrome Plated Shaft and Aluminum Magnet Housing
- Comfortable Molded Poly Handle with Soft, Non-Slip Rubber Grip
- Uses Three LR41 Button Cell Batteries (Included)

Item	Description	Packaging	Cs	In
7610	Telescoping Lighted Magnetic Pick-Up Tool	Slide Blister Card	72	12

3-pc. Pick-Up and Inspection Tool Set

INSPECTION MIRROR

- 2" Diameter Mirror
- Dual Ball Joint Positions Mirror at any Angle
- Extends from 11" to 17"
- Corrosion-Resistant Chrome Plated Shaft
- Comfortable Molded Poly Handle with Soft, Non-Slip Rubber Grip

LIGHTED MAGNETIC PICK-UP TOOL

- Retrieves Ferrous Metal Objects up to 1-1/2 lb.
- Bright White LED Illuminates Hidden Areas for Ultimate Visibility
- Dual Ball Joint Positions Magnet at any Angle
- Extends from 9" to 30"
- Corrosion-Resistant Chrome Plated Shaft and Aluminum Magnet Housing
- Comfortable Molded Poly Handle with Soft, Non-Slip Rubber Grip
- Uses Three LR41 Button Cell Batteries (Included)

MAGNETIC PARTS TRAY

- Rugged Stainless Steel Construction
- Soft-Coated Magnet Prevents Damage to Finished Surfaces
- Mounts to Hood, Fenders, or Other Ferrous Metal Surfaces Around Work Area
- Keeps Nuts, Bolts, Parts, and Small Tools within Reach, Preventing Loss or Misplacement
- Capacity: 2 lb.
- Dimensions: 5-1/2" Diameter, 1-1/8" D



Item	Description	Packaging	Cs	In
7612	3-pc. Pick-Up and Inspection Tool Set	Sealed Blister/Display Box	24	6



97603

7605
• AVAILABLE IN DISPLAY QUANTITIES ONLY

8-lb. Telescoping Magnetic Pickup Tool

- Powerful Magnet Lifts up to 8 lb.
- Chrome Plated Shaft Telescopes from 6-1/2" to 33"
- Removable Shielding Collar Prevents Magnetic Attraction to Non-Target Objects
- Non-Slip, Soft Finger Grip Handle

Item	Description	Packaging	Cs	In
7605	8-lb. Telescoping Magnetic Pickup Tool	UPC Label/Display Box	144	12
97603	8-lb. Telescoping Magnetic Pickup Tool	Color Label	300	12



24" Flexible Magnetic Pick-Up Tool

- Powerful Magnet Retrieves Ferrous Metal Objects up to 4 lb.
- 20" Black Electroplated Flexible Steel Tube Shaft
- Flexible Shaft Holds any Position to Reach into Tight Spots
- Comfortable Mechanic's-Style Handle
- 24" Overall Length

Item	Description	Packaging	Cs	In
7611	24" Flexible Magnetic Pick-Up Tool	Slide Blister Card	48	6



19" Flexible Inspection Mirror

- Chrome Plated Steel Construction
- Black Matted Cushion Grip for a Comfortable Hold
- Flexible Steel Shaft Holds any Position for Steady Viewing in Hard-to-See Areas
- Precision Ground Lens Optics
- 19" Overall Length with 2-1/2" Diameter Mirror

Item	Description	Packaging	Cs	In
7613	19" Flexible Inspection Mirror	Hang Card	96	6



2-pc. Telescoping Pick-Up and Inspection Tool Set

- Inspection Tool:
- 2" Diameter Inspection Mirror
 - Telescopes from 10" to 16"
 - Dual Swivel Ball Joint Holds Mirror at any Position
 - Non-Slip Cushion Grip
 - Durable Chrome Plated Finish

- Magnetic Pick-Up Tool:
- Retrieves Ferrous Metal Objects up to 2 lb.
 - Telescopes from 7" to 21"
 - Comfortable Contoured Handle
 - Durable Chrome Plated Finish

Item	Description	Packaging	Cs	In
7619	2-pc. Telescoping Pick-Up and Inspection Tool Set	Slide Blister Card	72	6

50-lb. Magnetic Pick-Up Tools

7615

- Super-Strong Magnet Lifts up to 50 lb.
- Retrieves Dropped Nails, Screws, Bolts, Tools, and Other Ferrous Metal Objects
- Comfortable Contoured Non-Slip Finger Grip Handle
- Extra Long 35" Shaft Quickly Sweeps Large Areas

7617

- Super-Strong Magnet Lifts up to 50 lb.
- Retrieves Dropped Nails, Screws, Bolts, Tools, and Other Ferrous Metal Objects
- Comfortable Contoured Non-Slip Finger Grip Handle
- Extra Long 35" Shaft Quickly Sweeps Large Areas
- 37" Telescoping Shaft Compacts to 21" for Storage



Item	Description	Packaging	Cs	In
7615	50-lb. Magnetic Pick-Up Tool	Color Label	12	4
7617	50-lb. Telescoping Magnetic Pick-Up Tool	Color Label	12	4



16" Shop Dust Pan

- Extra-Wide 16" Mouth
- Heavy Gauge Steel Construction
- Comfortable Non-Slip Cushioned Handle Grip
- Double-Riveted Tubular Steel Handle Lifts Heavy Loads
- Durable Electroplate Finish Resists Rust and Corrosion
- Heavy Duty For Shop, Garage, or Worksite

Item	Description	Packaging	Cs	In
7676	16" Shop Dust Pan	Color Label	24	6



1100-lb. Mover's Dolly

- Moves up to 1100 lb.
- Rugged Hardwood Construction
- Heavy Duty Non-Marring Swivel Casters Maneuver Easily in Tight Spaces
- Carpeted End Rails Protect Items from Damage
- Outside Dimensions: 30.5" x 18.5" x 6"

Item	Description	Packaging	Cs	In
5563	1100-lb. Mover's Dolly	Color Label	2	1

Wire Wheels and Brushes

- Industrial Quality Crimped Steel Wire
- Galvanized Steel Housing
- Universal Fit 1/4" Steel Shank
- Removes Rust, Paint, and Scale to Prepare Metal Surfaces for Painting and Welding

Item #					
7999	2"	Coarse	Wheel Brush	4500RPM	
8002	3"	Coarse	Wheel Brush	4500RPM	
8003	3"	Fine	Wheel Brush	4500RPM	
8004	4"	Coarse	Wheel Brush	4500RPM	
8005	2"	Coarse	Cup Brush	4500RPM	
8007	3"	Coarse	Cup Brush	2500RPM	
8008	3"	Fine	Cup Brush	2500RPM	



8005



7999



8007 / 8008



8002 / 8003

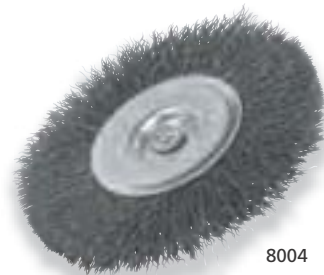

8004

Item	Description	Packaging	Cs	In
7999	2" Wire Wheel Brush - Coarse	Slide Blister Card	72	6
8002	3" Wire Wheel Brush - Coarse	Slide Blister Card	48	6
8003	3" Wire Wheel Brush - Fine	Slide Blister Card	48	6
8004	4" Wire Wheel Brush - Coarse	Slide Blister Card	24	6
8005	2" Wire Cup Brush - Coarse	Slide Blister Card	72	6
8007	3" Wire Cup Brush - Coarse	Slide Blister Card	24	6
8008	3" Wire Cup Brush - Fine	Slide Blister Card	24	6

Wire Wheel and Brush Assortments

- Industrial Quality Crimped Steel Wire
 - Galvanized Steel Housing
 - Universal Fit 1/4" Steel Shank
 - Removes Rust, Paint, and Scale to Prepare Metal Surfaces for Painting and Welding
- AVAILABLE IN DISPLAY QUANTITIES ONLY

- 8011**
- 5-pc. 2" Wire Cup Brushes (Fine)
 - 5-pc. 2" Wire Cup Brushes (Coarse)
 - 2-pc. 1-1/2" Wire Wheel Brushes (Fine)
 - 2-pc. 1-1/2" Wire Wheel Brushes (Coarse)
 - 2-pc. 2" Wire Wheel Brushes (Fine)
 - 2-pc. 2" Wire Wheel Brushes (Coarse)
 - 3-pc. 2-1/2" Wire Wheel Brushes (Fine)
 - 3-pc. 2-1/2" Wire Wheel Brushes (Coarse)
 - 3-pc. 3" Wire Wheel Brushes (Fine)
 - 3-pc. 3" Wire Wheel Brushes (Coarse)
- 8012**
- 5-pc. 3" Wire Cup Brushes (Coarse)
 - 5-pc. 3" Wire Cup Brushes (Fine)
 - 5-pc. 4" Wire Wheel Brushes (Coarse)
 - 5-pc. 4" Wire Wheel Brushes (Fine)



Item	Description	Packaging	Cs	In
8011	30-pc. Wire Wheel and Cup Brushes	UPC Label/Display Box	10	1
8012	20-pc. Wire Wheel and Cup Brushes	UPC Label/Display Box	10	1



6" Wire Wheel

- Industrial Quality Crimped Steel Wire
- Universal Fit for 6" Bench Grinders with 1/2" Arbor
- Removes Rust, Paint, and Scale to Prepare Metal Surfaces for Painting and Welding
- 4500 RPM Max.
- 6" Diameter
- 1/2" Arbor

Item	Description	Packaging	Cs	In
5021	6" Wire Wheel	Sealed Blister	40	5



6" Grinding Wheel

- Bonded Aluminum Oxide Abrasive
- Medium Grit
- Replacement Wheel for 6" Bench Grinders
- Maximum 4100 RPM
- 6" Diameter
- 3/4" Thick
- 1/2" Arbor

Item	Description	Packaging	Cs	In
5016	6" Grinding Wheel	Color Label	40	5

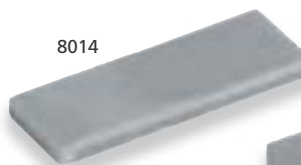

Sharpening Stones

- Bonded Aluminum Oxide Construction
- Dual Grade: Coarse and Fine Grit on Opposite Sides
- Sharpen and Hone Knives, Scissors and other Edged Tools

Item #	Size
8014	3" x 1" x 3/8"
8022	6" x 2" x 1"

Item	Description	Packaging	Cs	In
8014	Pocket Sharpening Stone	Slide Blister Card	96	12
8022	Sharpening Stone	Slide Blister Card	36	4

Mini Wire Brushes

7058

- Use for Cleaning and Polishing Small Parts and Hard to Get Areas
- 7-3/4" Durable Hardwood Handle
- Brass Bristles Cleans Metal Parts without Marring Surface or Danger of Sparking

7059

- Use for Cleaning and Polishing Small Parts and Hard to Get Areas
- 7-3/4" Durable Hardwood Handle
- Stainless Steel Bristles Attack Heavy Duty Scrubbing Jobs

Item	Description	Packaging	Cs	In
7058	Brass Mini Wire Brush	Bulk/UPC	480	24
7059	Stainless Steel Mini Wire Brush	Bulk/UPC	480	24



Long Handle Wire Brushes

7070

- Rugged 13" Natural Hardwood Handle
- Tempered Carbon Steel Bristles
- 3 x 19 Wire Bristle Configuration
- Removes Rust, Paint, and Dirt to Prepare Rough Surfaces for Paint and Other Finishes

7072

- Rugged 13" Natural Hardwood Handle
- Tempered Carbon Steel Bristles
- 3 x 19 Wire Bristle Configuration
- Galvanized Steel Scraper Loosens Tough Material
- Removes Rust, Paint, and Dirt to Prepare Rough Surfaces for Paint and Other Finishes

Item	Description	Packaging	Cs	In
7070	Long Handle Wire Brush	Color Label	120	12
7072	Long Handle Wire Brush with Scraper	Color Label	120	12



Shoe Handle Wire Brushes

7075

- Rugged 10" Natural Hardwood Shoe Handle
- Tempered Carbon Steel Bristles
- 4 x 16 Wire Bristle Configuration
- Removes Rust, Paint, and Dirt to Prepare Rough Surfaces for Paint and Other Finishes

7076

- Rugged 10" Natural Hardwood Shoe Handle
- Tempered Carbon Steel Bristles
- 4 x 16 Wire Bristle Configuration
- Galvanized Steel Scraper Loosens Tough Material
- Removes Rust, Paint, and Dirt to Prepare Rough Surfaces for Paint and Other Finishes

Item	Description	Packaging	Cs	In
7075	Shoe Handle Wire Brush	Color Label	120	12
7076	Shoe Handle Wire Brush with Scraper	Color Label	120	12





5-pc. Detail Brush Set

- Clean Hard-to-Reach Areas in Vehicle Interiors, on Exterior Panels, and Under the Hood
- Comfortable Contoured Handles
- Nylon Bristles Sweep out Dirt and Dust from Fine Contours along Dashboard, Instrument Panels, and Air Vents
- Brass Bristles Clean Metal Parts without Damaging Surface or Danger of Sparking
- Stainless Steel Bristles for Heavy Duty Scrubbing Jobs
- 1-pc. Nylon Wire Brush
- 1-pc. Brass Wire Brush
- 1-pc. Stainless Steel Wire Brush
- 1-pc. Nylon Parts Brush
- 1-pc. Nylon Fingernail Brush

Item	Description	Packaging	Cs	In
7063	5-pc. Detail Brush Set	Slide Blister Card	96	12



3-pc. Mini Wire Brush Set

- 7" Fingergrip Handles for Precise Control
- Nylon Bristles Clean Delicate Parts and Detail Vehicle Interiors
- Brass Bristles Clean Metal Parts without Damaging Surface or Danger of Sparking
- Stainless Steel Bristles for Heavy Duty Scrubbing Jobs
- 1-pc. Nylon Wire Brush
- 1-pc. Brass Wire Brush
- 1-pc. Stainless Steel Wire Brush

Item	Description	Packaging	Cs	In
7064	3-pc. Mini Wire Brush Set	Slide Blister Card	120	6

3-pc. Wire Brush Set

- Comfortable Contoured Fingergrip Handles
- 9" Overall Length
- Nylon Bristles Clean Delicate Parts and Detail Vehicle Interiors
- Brass Bristles Clean Metal Parts without Damaging Surface or Danger of Sparking
- Stainless Steel Bristles for Heavy Duty Scrubbing Jobs
- 1-pc. Nylon Bristle Brush
- 1-pc. Brass Bristle Brush
- 1-pc. Stainless Steel Bristle Brush

Item	Description	Packaging	Cs	In
7068	3-pc. Wire Brush Set	Slide Blister Card	36	6



Long Handle Wire Brush

- Heavy Duty 13" Poly Fingergrip Handle
- Tempered Carbon Steel Bristles
- 3 x 19 Wire Bristle Configuration
- Galvanized Steel Scraper Loosens Tough Material
- Removes Rust, Paint, and Dirt to Prepare Rough Surfaces for Paint and Other Finishes

Item	Description	Packaging	Cs	In
7073	Long Handle Wire Brush	Color Label	120	12



Shoe Handle Wire Brush

- Heavy-Duty 9" Poly Shoe Handle
- Tempered Carbon Steel Bristles
- 4 x 16 Wire Bristle Configuration
- Galvanized Steel Scraper Loosens Tough Material
- Removes Rust, Paint, and Dirt to Prepare Rough Surfaces for Paint and Other Finishes

Item	Description	Packaging	Cs	In
7074	Shoe Handle Wire Brush	Color Label	120	12

3-pc. Project Tool Set

• Essential Tools for Everyday Projects and Repairs

8-oz. Stubby Claw Hammer

- Full Size Forged and Hardened Steel Head
- Magnetic Nail-Starting Slot
- Non-Slip Contoured Rubber Handle Grip
- Stubby 6" Length for Small Jobs or Tight Work Areas

6-in-1 Screwdriver

- Rugged Sandblasted Chrome Vanadium Steel Bits
- Carbon Steel Tube Shaft with Chrome Plated Finish
- Oversized Handle with Non-Slip Cushioned Handle Grip

16' x 3/4" Tape Measure

- Impact-Resistant ABS Housing with Non-Slip Grip
- Sliding Thumb Switch Lock
- One-Touch Quick-Stop Button Pauses Tape at any Position
- Triple-Rivet Sliding End Hook for Accurate Inside and Outside Measurements
- Rapid Read™ Black-on-Yellow Blade Features:
 - Fractional Readout Every 1/8"
 - Stud Markings in Red Every 16"
 - 1/16" Graduations Throughout



• AVAILABLE IN DISPLAY QUANTITIES ONLY



Item	Description	Packaging	Cs	In
1831	3-pc. Project Tool Set	Sealed Blister/Display Box	24	6

3-pc. Project Tool Set

• Essential Tools for Everyday Projects and Repairs

Folding Sport Utility Knife

- Push Button Quick-Change Folding Utility Blade
- 3" Standard/Serrated Knife Blade
- Aluminum Frame with Non-Slip Rubber Grips

6-in-1 Screwdriver

- Rugged Sandblasted Chrome Vanadium Steel Bits
- Carbon Steel Tube Shaft with Chrome Plated Finish
- Oversized Handle with Non-Slip Cushioned Handle Grip

16' x 3/4" Tape Measure

- Impact-Resistant ABS Housing with Non-Slip Grip
- Sliding Thumb Switch Lock
- One-Touch Quick-Stop Button Pauses Tape at any Position
- Triple-Rivet Sliding End Hook for Accurate Inside and Outside Measurements
- Rapid Read™ Black-on-Yellow Blade Features:
 - Fractional Readout Every 1/8"
 - Stud Markings in Red Every 16"
 - 1/16" Graduations Throughout



• AVAILABLE IN DISPLAY QUANTITIES ONLY



Item	Description	Packaging	Cs	In
1832	3-pc. Project Tool Set	Sealed Blister/Display Box	24	6

3-pc. Project Tool Set

• Essential Tools for Everyday Projects and Repairs

8-oz. Stubby Claw Hammer

- Full Size Forged and Hardened Steel Head
- Magnetic Nail-Starting Slot
- Non-Slip Contoured Rubber Handle Grip
- Stubby 6" Length for Small Jobs or Tight Work Areas

Folding Sport Utility Knife

- Push Button Quick-Change Folding Utility Blade
- 3" Standard/Serrated Knife Blade
- Aluminum Frame with Non-Slip Rubber Grips

16' x 3/4" Tape Measure

- Impact-Resistant ABS Housing with Non-Slip Grip
- Sliding Thumb Switch Lock
- One-Touch Quick-Stop Button Pauses Tape at any Position
- Triple-Rivet Sliding End Hook for Accurate Inside and Outside Measurements
- Rapid Read™ Black-on-Yellow Blade Features:
 - Fractional Readout Every 1/8"
 - Stud Markings in Red Every 16"
 - 1/16" Graduations Throughout



• AVAILABLE IN DISPLAY QUANTITIES ONLY



Item	Description	Packaging	Cs	In
1833	3-pc. Project Tool Set	Sealed Blister/Display Box	24	6

4-pc. Home Project Tool Set

- Compact Assortment of Everyday Essential Home Project Tools
- Rugged Forged Heat Treated Steel Construction
- Non-Slip Comfort Grip Handles

- 1-pc. 6" Diagonal Cutting Pliers
- 1-pc. 6" Linesman Pliers
- 1-pc. 8oz. Stubby Claw Hammer
- 1-pc. 8" Adjustable Wrench

Item	Description	Packaging	Cs	In
1851	4-pc. Home Project Tool Set	Sealed Blister	12	2





• AVAILABLE IN DISPLAY QUANTITIES ONLY



2-pc. LED Light, Utility Knife W/ Bonus Keychain LED

Folding Sport Utility Knife

- Push Button Quick-Change Folding Utility Blade
- 3" Standard Knife Blade
- Stainless Steel Blades and Aluminum Handle Grips

Bonus 2-LED Mini Keychain Flashlight (Batteries Included)

- 1-pc. 2-in-1 Compact Worklight (Batteries Included)
- 1-pc. Quick-Change Folding Sport Utility Knife
- 1-pc. Bonus 2-LED Mini Keychain Flashlight (Batteries Included)

2-in-1 Compact Worklight

- Compact All-Purpose Worklight for Auto, Home, and Garage
- 2-in-1 Design: 24-LED Worklight and 3-LED Flashlight
- Convenient Fold Away Hanging Hook
- Built-In Magnet Mounts Light to Metal Surfaces
- Uses Three "AAA" Batteries (Included)

Item	Description	Packaging	Cs	In
1834	2-pc. LED Light, Utility Knife W/ Bonus Keychain LED	Sealed Blister/Display Box	24	6



• AVAILABLE IN DISPLAY QUANTITIES ONLY



2-pc. Multi-Tool and Knife Set

10-in-1 Multi-Tool

- Rugged, Corrosion-Resistant Stainless Steel Construction
- Durable Anodized Aluminum Handle Scales with Non-Slip Grips
- Self-Opening Spring-Loaded Pliers Handles Reduce Fatigue
- Non-Slip Soft Handle Grips
- Folds to Compact Pocket Size
- 10 Tools in 1: Pliers, Wire Cutters, Knife, Awl/Knife, 3mm Flat Screwdriver, 2mm Flat Screwdriver, Phillips Screwdriver, Flat File, Saw, Can/ Bottle Opener

Folding Sport Utility Knife

- Push Button Quick-Change Folding Utility Blade
- 3" Standard Knife Blade
- Stainless Steel Blades and Aluminum Handle Grips
- 1-pc. Multi-Tool
- 1-pc. Folding Knife

Item	Description	Packaging	Cs	In
1835	2-pc. Multi-Tool and Knife Set	Sealed Blister/Display Box	32	8



• AVAILABLE IN DISPLAY QUANTITIES ONLY



3-pc. LED Light, Sport Utility Knife and Multi-Tool Set

Folding Sport Utility Knife

- Push Button Quick-Change Folding Utility Blade
- 3" Standard Knife Blade
- Stainless Steel Blades and Aluminum Handle Grips

10-in-1 Multi-Tool

- Rugged, Corrosion-Resistant Stainless Steel Construction
- Durable Anodized Aluminum Handle Scales with Non-Slip Grips
- Self-Opening Spring-Loaded Pliers Handles Reduce Fatigue
- Non-Slip Soft Handle Grips
- Folds to Compact Pocket Size
- 10 Tools in 1: Pliers, Wire Cutters, Knife, Awl/Knife, 3mm Flat Screwdriver, 2mm Flat Screwdriver, Phillips Screwdriver, Flat File, Saw, Can/ Bottle Opener

2-in-1 Compact Worklight

- Compact All-Purpose Worklight for Auto, Home, Garage
- 2-in-1 Design: 24-LED Worklight and 3-LED Flashlight
- Convenient Fold Away Hanging Hook
- Built-In Magnet Mounts Light to Metal Surfaces
- Uses Three "AAA" Batteries (Included)

- 1-pc. 2-in-1 Compact Worklight
- 1-pc. Folding Sport Utility Knife
- 1-pc. 10 in 1 Multi Tool

Item	Description	Packaging	Cs	In
1836	3-pc. LED Light, Sport Utility Knife and Multi-Tool Set	Sealed Blister/Display Box	24	6

52-pc. Ratchet Screwdriver Set

- Ratcheting Screwdriver with 3-Position Drive (Forward, Fixed, and Reverse) and Non-Slip Soft Handle Grip
 - Precision Screwdriver Features Spinning Endcap for Application of Constant Finger Pressure While Turning
 - Precision-Milled Chrome Vanadium Steel Bits
 - 1-pc. Ratcheting Screwdriver
 - 20-pc. 1" Screwdriver Bits
- Flat: 1/16, 5/64, 3/32, 1/8
 Phillips: #1, #2, #3
 Star: SD-10, SD-15, SD-20, SD-25
 Square: S1, S2, S3
 Hex: 3mm, 4mm, 5mm
 Pozi: PZ 1, PZ 2 (2-pc.)
- 1-pc. Precision Screwdriver
 - 30-pc. Precision Screwdriver Bits
- Flat: 1, 1.5, 2, 2.5, 3, 3.5, 4mm
 Phillips: #000, #00, #0, #1
 Star: SD-4, SD-5, SD-6, SD-7, SD-8, SD-9, SD-10, SD-15, SD-20
 Hex: 0.7, 0.9, 1.3, 1.5, 2, 2.5, 3, 4mm
 Pozi: PZ 0, PZ 1



• AVAILABLE IN DISPLAY QUANTITIES ONLY



Item	Description	Packaging	Cs	In
2832	52-pc. Ratchet Screwdriver Set	Color Label/Display Box	24	6

22-pc. Stubby Ratchet Screwdriver Set

- Stubby Screwdriver Fits in Tight Work Areas
 - 3-Position Ratchet Drive: Forward, Fixed, and Reverse
 - Non-Slip Soft Handle Grip
 - Convenient Bit Storage in Handle
 - Precision-Milled Chrome Vanadium Steel Bits
 - 1-pc. Stubby Ratchet Screwdriver
 - 21-pc. 1" Screwdriver Bits
- Flat: 1/16", 5/64", 3/32", 1/8", 5/32", 3/16", 1/4"
 Phillips: #0, #1, #2, #3
 Star: SD-10, SD-15, SD-20, SD-25
 Square: S1, S2, S3
 Hex: 3, 4, 5mm



• AVAILABLE IN DISPLAY QUANTITIES ONLY



Item	Description	Packaging	Cs	In
2843	22-pc. Stubby Ratchet Screwdriver Set	Color Label/Display Box	40	10

36-pc. Precision Screwdriver Set

- Precision Screwdriver Features Spinning Endcap for Application of Constant Finger Pressure While Turning
 - Precision-Milled Chrome Vanadium Steel Bits
 - 1-pc. Precision Screwdriver
 - 1-pc. 4-3/4" Extension Bit Holder
 - 34-pc. Precision Bits:
- 7-pc. Flat: 3/64", 1/16", 5/64", 3/32", 1/8", 9/64", 5/32"
 8-pc. Phillips: #000, #00, #0, #1(2)
 3-pc. Pozi: PZ00, PZ0, PZ1
 8-pc. Hex: 1/32", 3/64", 1/16", 5/64", 3/32", 1/8", 9/64", 5/32"
 11-pc. Star: SD-4, SD-5, SD-6, SD-7, SD-8, SD-9, SD-10, SD-15(2), SD-20(2)



• AVAILABLE IN DISPLAY QUANTITIES ONLY



Item	Description	Packaging	Cs	In
2845	36-pc. Precision Screwdriver Set	Color Label/Display Box	24	6

• AVAILABLE IN DISPLAY QUANTITIES ONLY



2-pc. Compact LED Worklight Set

- Compact All-Purpose Worklights for Auto, Home, Garage, and Workshop
- 2-in-1 Design Features a 24-LED Worklight and 3-LED Flashlight
- Convenient Fold Away Hanging Hook
- Built-In Magnet Mounts Light to Metal Surfaces

- Each Worklight Uses Three "AAA" Batteries (Included)

Item	Description	Packaging	Cs	In
7476	2-pc. Compact LED Worklight Set	Sealed Blister/Display Box	48	6

• AVAILABLE IN DISPLAY QUANTITIES ONLY



2-pc. LED Flashlight / Worklight Set

- 8 LED Flashlight with Laser Pointer
- Super Bright 8-LED Flashlight (8-12,000 MCD Bright LED)
- 50' Laser Pointer Range
- Rugged Aluminum Housing with Non-Slip Knurled Grip
- Uses Three "AAA" Batteries (Included)

- 27 LED 2-in-1 Worklight/Flashlight
- Compact All-Purpose Worklight for Auto, Home, Garage
- 2-in-1 Design: 24-LED Worklight and 3-LED Flashlight
- Convenient Fold Away Hanging Hook
- Built-In Magnet Mounts Light to Metal Surfaces
- Uses Three "AAA" Batteries (Included)

Item	Description	Packaging	Cs	In
7477	2-pc. LED Flashlight / Worklight Set	Sealed Blister/Display Box	48	6



2-pc. LED Flashlight Set with Bonus Keychain Flashlight

- 21 LED Flashlight
- Rugged Aluminum Housing with Non-Slip Rubber Grip
- Uses Three "AAA" Batteries (Included)

- BONUS 1 LED Mini Keychain Flashlight
- Rugged Aluminum Housing
- Uses Three Button Cell Batteries (Included)

- 9 LED Flashlight
- Rugged Aluminum Housing with Non-Slip Knurled Grip
- Uses Three "AAA" Batteries (Included)

Item	Description	Packaging	Cs	In
7478	2-pc. LED Flashlight Set with Bonus Keychain Flashlight	Sealed Blister/Display Box	48	6



3-pc. LED Flashlight Set

- 8 LED Flashlight / Laser Pointer
- Compact Rugged Aluminum Housing with Non-Slip Knurled Grip
- 50' Laser Pointer Range
- 4-Position Power Switch: Flashlight ON/OFF and Laser Pointer ON/OFF

- 12 LED Flashlights
- Compact Rugged Aluminum Housing with Non-Slip Knurled Grip
- Each Light Uses Three "AAA" Batteries (Included)

Item	Description	Packaging	Cs	In
7480	3-pc. LED Flashlight Set	Sealed Blister/Display Box	24	6

• AVAILABLE IN DISPLAY QUANTITIES ONLY

9 LED Mini Flashlight

- Ultra Bright 9-LED Light Head
- Rugged Aluminum Housing
- Knurled Handle for Better Grip
- Compact Pocket Size
- Uses Three "AAA" Batteries (Included)

• AVAILABLE IN DISPLAY QUANTITIES ONLY



Item	Description	Packaging	Cs	In
7479	9 LED Mini Flashlight	UPC Label/Display Box	48	12

RECHARGEABLE



Lightstorm™ Ion™ Cordless LED Worklight

- Cordless, Go-Anywhere Design is Ideal for Any Work Area, Roadside or Power Outage Emergency, Campsite, and More
- 30 Bright White LED Bulbs Provide Focused Light Output
- Convenient Stand-Up Magnetic Base and Three Hanging Hooks
- 2-Stage Power-Saving Switch: Operates 30 LED's for Max Illumination or 10 LED's for Extended Run Time
- Longer Continuous Operation: Up to 3 Hours (30 LED) or 7 Hours (10 LED) Before Recharging
- Advanced Battery Technology: Long-Lasting Nickel-Metal Hydride Batteries can be Recharged over 500 Times

- Power: 7.2 Volts
- Battery Pack: Six 1.2 Volt, 0.60 Amp/Hour NiMH cells
- LED-Bulb Life: 100,000 Hrs.
- Light Output: 420 Lumens (40 Watt equivalent)
- Dimensions: 18" Long, 1-1/2" Body Dia., 3" Base Dia.

Item	Description	Packaging	Cs	In
6116	Lightstorm™ Ion™ Cordless LED Worklight	Sealed Blister	12	2

RECHARGEABLE



36 LED 2-in-1 Worklight/Flashlight

- 2-in-1 Design: Compact Telescoping Housing Extends from Standard Flashlight (6 LED) to Worklight (30 LED)
- Scratch-Resistant, Coated Magnetic Base Mounts Light to Metal Surfaces without Damaging Finish
- Rugged ABS Construction with Impact-Resistant Polycarbonate Lenses
- Soft-Coated Non-Slip Housing
- Hex-Shaped Light Head Prevents Rolling on Flat Surfaces
- Red/Green Light Indicates Full Charge

- Power: 3.6 Volts
- Battery Pack: Rechargeable, 3.6 V, 1.0 Ah, Ni-MH
- LED-Bulb Life: 100,000 Hrs.
- Run Time: 3 hours (30 LEDs), 8 hours (6 LEDs)
- Recharge Time: 4-6 hours
- Light Output: 30 LEDs: 45 lumens, 6 LEDs: 12 lumens
- Dimensions: 10" L (14-1/4" extended), 2-1/2" Diameter

Item	Description	Packaging	Cs	In
6119	36 LED 2-in-1 Worklight/Flashlight	Sealed Blister	12	2

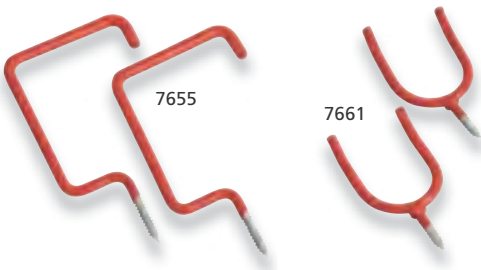

Utility Storage Hooks

- 7646**
- Galvanized Steel Construction
 - Soft Non-Marring, Non-Slip Coated Finish
 - Simple and Easy Installation
 - Use for Ceiling Storage of Bicycles, Lawn Furniture, and Garden Hoses
 - 60 lb. Capacity (per Hook)
 - Requires 3/16" dia. Pilot Hole

- 7651**
- Galvanized Steel Construction
 - Soft Non-Marring, Non-Slip Coated Finish
 - Simple and Easy Installation
 - Use for Wall Storage of Ladders, Garden Hoses, and Recreational Equipment
 - 20 lb. Capacity (per Hook)
 - Requires 5/32" dia. Pilot Hole

- 7655**
- Galvanized Steel Construction
 - Soft Non-Marring, Non-Slip Coated Finish
 - Simple and Easy Installation
 - Use for Ceiling Storage of Ladders, Garden Hoses, and Recreational Equipment
 - 25 lb. Capacity (per Hook)
 - Requires 5/32" dia. Pilot Hole

- 7661**
- Galvanized Steel Construction
 - Soft Non-Marring, Non-Slip Coated Finish
 - Simple and Easy Installation
 - Use for Wall Storage of Long Handled Tools Including Shovels, Brooms, and Rakes
 - 15 lb. Capacity (per Hook)
 - Requires 1/8" dia. Pilot Hole

Item	Description	Packaging	Cs	In
7646	2-pc. Bike Hooks	Slide Blister Card	96	12
7651	2-pc. Ladder Hooks	Slide Blister Card	96	12
7655	2-pc. Ladder Hooks	Slide Blister Card	96	12
7661	2-pc. Tool Hooks	Slide Blister Card	96	12

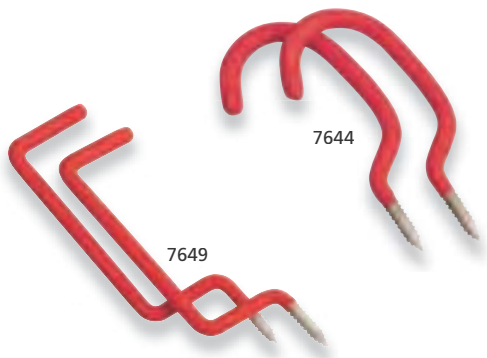

Heavy Duty Utility Storage Hooks

- 7644**
- Heavy Duty Galvanized Steel Construction
 - Soft Non-Marring, Non-Slip Coated Finish
 - Simple and Easy Installation
 - Use for Ceiling Storage of Bicycles, Lawn Furniture, and Garden Hoses
 - 100 lb. Capacity (per Hook)
 - Requires 5/16" dia. Pilot Hole

- 7649**
- Heavy Duty Galvanized Steel Construction
 - Soft Non-Marring, Non-Slip Coated Finish
 - Simple and Easy Installation
 - Use for Wall Storage of Ladders, Garden Hoses, and Recreational Equipment
 - 50 lb. Capacity (per Hook)
 - Requires 5/16" dia. Pilot Hole

Item	Description	Packaging	Cs	In
7644	2-pc. Heavy Duty Bike Hooks	Slide Blister Card	36	4
7649	2-pc. Heavy Duty Ladder Hooks	Slide Blister Card	36	4



144-pc. Cotter Pin and Puller Set

- General Purpose Assortment of Common Cotter Pin Sizes
- Steel Construction with Galvanized Finish
- Includes Installer/Puller Tool
- 40-pc. 1/16" x 3/4"
- 40-pc. 3/32" x 3/4"
- 40-pc. 3/32" x 1"
- 12-pc. 1/8" x 1"
- 12-pc. 1/8" x 1-1/4"
- Complete with Installer/Puller Tool

Item	Description	Packaging	Cs	In
7685	144-pc. Cotter Pin and Puller Set	Poly Bag/Hang Card	100	10

50-pc. O-Ring Assortment

- General Purpose O-Rings Seal Air, Plumbing, and Other Connections Against Leaks
- BUNA-N Material is Oil Proof and Passes ASTM Oil #1 and #3 Laboratory Tests

- 8-pc. 1/4" x 3/8"
- 8-pc. 3/8" x 1/2"
- 5-pc. 3/8" x 9/16"
- 3-pc. 7/16" x 5/8"
- 3-pc. 1/2" x 11/16"
- 3-pc. 9/16" x 3/4"
- 5-pc. 5/8" x 3/4"
- 3-pc. 5/8" x 13/16"
- 3-pc. 3/4" x 15/16"
- 3-pc. 3/4" x 1"
- 3-pc. 13/16" x 1-1/16"
- 3-pc. 11/16" x 7/8"



Item	Description	Packaging	Cs	In
7712	50-pc. O-Ring Assortment	Slide Blister Card	72	12

Compact Utility Tool Pouch

- All-Purpose Compact Utility Tool Pouch
- Rugged, Weather-Resistant Woven Nylon Stands up to Harsh Worksite Environments
- 50% Lighter than Leather
- Comfortable Padded Back
- Fits up to 2" Wide Belt
- Includes Large Main Pocket, Two Side Pockets, Nail Pouch, Hammer Loop, and More

Item	Description	Packaging	Cs	In
7028	Compact Utility Tool Pouch	Wrap or Tie Card	24	2



Laminated Steel Padlocks

- Case Hardened Steel Shackle Resists Sawing and Cutting
- Weather-Resistant, Chrome Plated Laminated Steel Body
- Solid Brass Cylinder and 4-Pin Tumbler
- Cushioned Bumper will not Scratch Surfaces
- Includes 2-pc. Key Set

Item #	Body Width	Shackle Clearance (H)	Shackle Clearance (W)
7745	1-1/4" (32mm)	11/16" (18mm)	9/16" (15mm)
7750	1-1/2" (40mm)	15/16" (24mm)	3/4" (20mm)
7755	1-3/4" (45mm)	1" (25mm)	13/16" (21mm)
7765	2" (50mm)	1-1/8" (29mm)	15/16" (24mm)

Item	Description	Packaging	Cs	In
7745	1-1/4" Laminated Steel Padlock	Slide Blister Card	240	12
7750	1-1/2" Laminated Steel Padlock	Slide Blister Card	72	12
7755	1-3/4" Laminated Steel Padlock	Slide Blister Card	72	12
7765	2" Laminated Steel Padlock	Slide Blister Card	48	12



2-pc. 1-1/2" Laminated Steel Padlocks

- Case Hardened Steel Shackle Resists Sawing and Cutting
- Weather-Resistant, Chrome Plated Laminated Steel Body
- Solid Brass Cylinder and 4-Pin Tumbler
- Cushioned Bumper will not Scratch Surfaces
- Each Lock Includes 2-pc. Key Set
- Same Key Opens Both Locks

Item	Description	Packaging	Cs	In
7751	2-pc. 1-1/2" Laminated Steel Padlocks	Slide Blister Card	36	6

4-pc. 1-1/2" Laminated Steel Padlocks

- Case Hardened Steel Shackle Resists Sawing and Cutting
- Weather-Resistant, Chrome Plated Laminated Steel Body
- Solid Brass Cylinder and 4-Pin Tumbler
- Cushioned Bumper will not Scratch Surfaces
- Each Lock Includes 2-pc. Key Set
- Same Key Opens All Four Locks

Item	Description	Packaging	Cs	In
7752	4-pc. 1-1/2" Laminated Steel Padlocks	Slide Blister Card	24	6



9-pc. 5-lb. Slide Hammer Dent Puller Set

- 5-lb. Malleable Steel Slide Hammer
- Solid Steel Shaft with Non-Slip, Fingergrasp Handle
- Fully Hardened, Drop Forged Steel Hook and Puller Attachments
- 1-pc. 5-lb. Slide Hammer Puller (18 TPI)
- 1-pc. Nose Adapter (18 TPI I.D. x 14 TPI O.D.)
- 1-pc. Nose Cone (18 TPI x 24 TPI)
- 1-pc. Metal Pulling Screw (14 TPI)
- 1-pc. Pierce Punch (24 TPI x 13 TPI)
- 2-pc. Puller Hooks
- 1-pc. Plate Edge Puller
- 1-pc. L-Puller

Item	Description	Packaging	Cs	In
5632	9-pc. 5-lb. Slide Hammer Dent Puller Set	Color Box	9	1



13-pc. 10-lb. Slide Hammer Dent Puller Set

- 10-lb. Malleable Steel Slide Hammer
- Solid Steel Shaft with Knurled Handle for Sure Grip
- Fully Hardened Drop Forged Steel Hooks, Pullers, and Attachments
- 1-pc. 10-lb. Slide Hammer Puller (14 TPI)
- 1-pc. Nose Adapter (14 TPI I.D. x 18 TPI O.D.)
- 1-pc. Nose Cone (18 TPI x 11 TPI)
- 1-pc. Metal Pulling Screw
- 1-pc. Metal Hook and Chain
- 7-pc. Assorted Puller Attachments
- 1-pc. Molded Plastic Case

Item	Description	Packaging	Cs	In
5635	13-pc. 10-lb. Slide Hammer Dent Puller Set	Color Label	2	1



17-pc. 5-lb. Slide Hammer Puller Set

- 5-lb. Malleable Steel Slide Hammer
- Solid Steel T-Handle Shaft
- Fully Hardened Alloy Steel Attachments
- Includes Combination Puller, 2- and 3-Jaw Gear Puller, Dent and Panel Puller Attachments
- 1-pc. 5-lb. Slide Hammer Puller (18 TPI)
- 1-pc. Dent Puller Bar
- 3-pc. Screw, Hook, and Axle Adapters
- 1-pc. Dent Puller Screw (2" x 11 TPI)
- 3-pc. Gear Puller Arms
- 1-pc. 2-Jaw Gear Pulling Head
- 1-pc. 3-Jaw Gear Pulling Head
- 3-pc. Gear Puller Mounting Bolts
- 1-pc. Locking Pliers Adapter
- 1-pc. Locking Nut
- 1-pc. Molded Plastic Case

Item	Description	Packaging	Cs	In
5645	17-pc. 5-lb. Slide Hammer Puller Set	Color Label	2	1



22" x 1-1/4" Universal Lockout Tool

- Universal Catch Tip Design Releases Many Common Vehicle Door Lock Configurations
- Bendable, Ultra-Slim Spring Steel Construction Easily Slides Between Window and Weather Stripping
- Dimensions: 22" L x 1-1/4" W x 0.7mm

Item	Description	Packaging	Cs	In
6064	22" x 1-1/4" Universal Lockout Tool	Skin Card	200	20



5-1/4" Suction Cup Dent Puller

- Rugged One-Piece Molded Rubber Construction
- 5-1/4" Cup Diameter
- Quick Release Pegs
- Pulls Dents Out of Vehicle Panels with no Drilling or Damage to Finish
- Grips Smooth Sheet Materials Like Plate Glass, Paneling, and Sheet Metal for Easy Lifting and Carrying

Item	Description	Packaging	Cs	In
5650	5-1/4" Suction Cup Dent Puller	Slide Blister Card	72	4



4" Suction Cup Dent Puller

- Rugged, High-Impact Nylon Construction
- 4" Diameter Heavy Duty Rubber Suction Cup
- Quick Release Handle
- Pulls Dents Out of Vehicle Panels with no Drilling or Damage to Finish
- Grips Smooth Sheet Materials Like Plate Glass, Paneling, and Sheet Metal for Easy Lifting and Carrying

Item	Description	Packaging	Cs	In
5652	4" Suction Cup Dent Puller	Slide Blister Card	24	2



7-pc. Deluxe Auto Body Repair Kit

- Drop Forged, Heat Treated Steel Heads and Dollies
- Precision-Ground and Polished Faces
- Epoxy-Bonded Fiberglass Handles with Non-Slip Rubber Grips
- Reshape Damaged Body Panels to Original Contour
- 3-pc. Bumping Hammers: Standard Bumping, Chisel-End Finishing, and Pick-End Finishing
- 4-pc. Bumping Dollies: Curved, Utility, Double-End, and Heel
- Complete with Snap-In Carry Case

Item	Description	Packaging	Cs	In
5655	7-pc. Deluxe Auto Body Repair Kit	Color Box	4	1



7-pc. Auto Body Repair Kit

- Drop Forged, Heat Treated Steel Heads and Dollies
- Precision-Ground and Polished Faces
- Kiln-Dried Natural Hardwood Handles
- Reshape Damaged Body Panels to Original Contour
- 3-pc. Bumping Hammers: Standard Bumping, Reverse-Curve, and Pick-End Finishing
- 4-pc. Bumping Dollies: Curved, Utility, Double-End, and Heel

Item	Description	Packaging	Cs	In
5656	7-pc. Auto Body Repair Kit	Color Box	4	1

3-pc. Body Filler Spreader Set

- Use to Apply Body Filler, Putty and Fiberglass Resin
- Flexible Construction Follows Contours, Applying Filler Smoothly and Evenly
- Color-Matched Mix Indicator: Body Filler and Hardener are Properly Mixed when Color Matches Spreader Color
- Self-Cleaning: Simply Flex Spreader to Break Off Dried Filler

- 3-pc. Body Filler Spreaders:
4" Wide (2-1/2" H)
5" Wide (3" H)
6" Wide (3-1/4" H)

Item	Description	Packaging	Cs	In
5670	3-pc. Body Filler Spreader Set	Slide Blister Card	120	6



Door Panel Remover

- Quickly Loosens Door Panel Fasteners without Damage
- Universal Design
- Forged and Heat Treated Steel Shaft
- Corrosion-Resistant Chrome Plated Finish
- Square Mechanic's Handle for Sure Grip

Item	Description	Packaging	Cs	In
5873	Door Panel Remover	Slide Blister Card	72	6



3-Jaw Gear Pullers

- Drop Forged, Heat Treated Steel Jaws with Corrosion-Resistant Chrome Plated Finish
- Precision-Machined Hardened Self-Centering Steel Screw
- 4-Position Reversible Inside/Outside and Shallow/Deep Jaws
- Applies Even Pressure to Remove Gears, Pulleys, and Flywheels from Shaft without Damage

Item #	Jaw Size	Wrench Needed
5680	3"	9/16" (14mm)
5685	4"	5/8" (16mm)
5690	6"	11/16" (17mm)
5692	8"	7/8" (22mm)

Item	Description	Packaging	Cs	In
5680	3" 3-Jaw Gear Puller	Slide Blister Card	48	6
5685	4" 3-Jaw Gear Puller	Slide Blister Card	20	5
5690	6" 3-Jaw Gear Puller	Color Box	10	1
5692	8" 3-Jaw Gear Puller	Color Box	6	1



2-Jaw Gear Puller

- Drop Forged, Heat Treated Steel Jaws with Corrosion-Resistant Chrome Plated Finish
- Precision-Machined Hardened Self-Centering Steel Screw
- 4-Position Reversible Inside/Outside and Shallow/Deep Jaws
- Applies Even Pressure to Remove Gears, Pulleys, and Flywheels from Shaft without Damage

Item #	Jaw Size	Wrench Needed
5681	3"	9/16" (14mm)
5686	4"	5/8" (16mm)
5691	6"	11/16" (17mm)

Item	Description	Packaging	Cs	In
5681	3" 2-Jaw Gear Puller	Slide Blister Card	50	5
5686	4" 2-Jaw Gear Puller	Slide Blister Card	30	5
5691	6" 2-Jaw Gear Puller	Slide Blister Card	20	5



3-pc. Gear Puller Set

- Drop Forged, Heat Treated Steel Jaws with Corrosion-Resistant Chrome Plated Finish
- Precision-Machined Hardened Self-Centering Steel Screw
- 4- or 8-Position Reversible Inside/Outside and Shallow/Deep Jaws
- Applies Even Pressure to Remove Gears, Pulleys, and Flywheels from Shaft without Damage

Jaw Size	Wrench Needed
3"	9/16" (14mm)
4"	5/8" (16mm)
6"	11/16" (17mm)

Item	Description	Packaging	Cs	In
5696	3-pc. Gear Puller Set	Color Box	6	1



4-pc. Gear Puller Set

- Drop Forged, Heat Treated Steel Jaws with Corrosion-Resistant Chrome Plated Finish
- Precision-Machined Hardened Self-Centering Steel Screw
- 4- or 8-Position Reversible Inside/Outside and Shallow/Deep Jaws
- Applies Even Pressure to Remove Gears, Pulleys, and Flywheels from Shaft without Damage

Jaw Size	Wrench Needed
3"	9/16" (14mm)
4"	5/8" (16mm)
6"	11/16" (17mm)
8"	7/8" (22mm)

Item	Description	Packaging	Cs	In
5702	4-pc. Gear Puller Set	Color Box	4	1



Bearing Separator and Puller Set

- Cast Steel Bearing Splitter and Yoke
- Precision-Machined, Hardened and Tempered Steel Bolts
- Corrosion-Resistant Black Oxide Finish
- Applies Even Pressure to Smoothly Separate Bearings and Remove Gears from Shaft without Damage

- Capacities:
- Bearing Splitter
 - 1-pc. Bearing Splitter
 - 2-pc. 5" x 1/2" (12 TPI) Draw Bolts
 - Min. Spread: 5/8"
 - Max. Spread: 2-1/4"
 - 4-pc. 6-1/2" Push Puller Legs: 3/8" (16 TPI) x 5/16" (18 TPI)
 - Puller Yoke
 - 1-pc. Puller Yoke: 7" Width
 - 1-pc. 6" Center Screw
 - Width: 7"
 - Center Bolt: 7" x 9/16"
 - 2-pc. Center Screw Tips: Cone, Cylinder
 - 2-pc. 4" Puller Jaws: 3/8" (16 TPI)
 - 1-pc. Storage Case

Item	Description	Packaging	Cs	In
5704	Bearing Separator and Puller Set	Color Box	4	1



12" Ball Joint Separator

- Drop Forged, Heat Treated Steel Construction
- Durable Zinc Plated Finish Resists Corrosion
- Tapered Wedge with 1" Opening
- Non-Slip Knurled Handle Grip
- Slides Between and Separates Ball Joint and Steering Knuckle

Item	Description	Packaging	Cs	In
5732	12" Ball Joint Separator	Sealed Blister	36	6

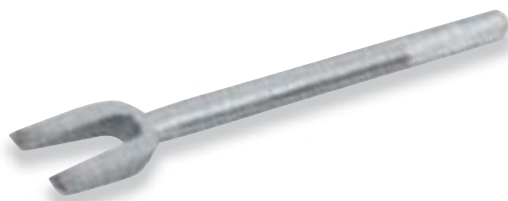

16" Tie Rod Separator

- Drop Forged, Heat Treated Steel Construction
- Durable Zinc Plated Finish Resists Corrosion
- Tapered Wedge with 7/8" Opening
- Non-Slip Knurled Handle Grip
- Slides Between and Separates Tie Rod End and Steering Knuckle

Item	Description	Packaging	Cs	In
5733	16" Tie Rod Separator	Sealed Blister	24	6

Pilot Bearing Puller

- Forged and Heat Treated Chrome Vanadium Steel Jaws
- Corrosion-Resistant Black Oxide Finish
- Three Jaw Design Applies Even Pressure Preventing Damage to Bearings
- Fits all 3/4" - 2" I.D. Sleeve-Type Bearings
- Pulls Pilot Bearings, Pump Bearings, and Bushings



Item	Description	Packaging	Cs	In
5740	Pilot Bearing Puller	Sealed Blister	24	6

Pitman Arm Puller

- Drop Forged, Heat Treated Steel Yoke
- Zinc Plated Finish Resists Corrosion
- Hardened and Tempered, Precision-Machined Center Screw
- Smoothly Pulls Pitman Arm from Mount without Damage



- Specifications:
- Wrench Size: 3/4"/19mm or 3/8" Direct Drive
 - Jaw Opening: 1-5/16" (33mm)
 - Inside Jaw Width: 2-1/2" (64mm)
 - Throat Depth: 2-1/4" (57mm)

Item	Description	Packaging	Cs	In
5747	Pitman Arm Puller	Slide Blister Card	24	6



13-pc. Harmonic Balance Puller

- Rugged Cast Steel Yoke
- Center Screw with Removable Swivel Tip
- Precision-Machined Bolts
- Multi-Purpose Puller Applies Pressure to Hub to Safely Remove Harmonic Balances, Crankshaft Pulleys, and Steering Wheels
- 1-pc. Yoke
- 1-pc. Center Screw
- 1-pc. Center Screw Tip
- 3-pc. 1/4" (18 TPI) x 2" Puller Bolts
- 3-pc. 3/8" (24 TPI) x 2" Puller Bolts
- 2-pc. 3/8" (16 TPI) x 3-3/4" Puller Bolts
- 2-pc. 5/16" (20 TPI) x 3" Puller Bolts

Item	Description	Packaging	Cs	In
5750	13-pc. Harmonic Balance Puller	Sealed Blister	20	5



46-pc. Harmonic Balance Puller

- Rugged Drop Forged, Heat Treated Steel Yoke
- Universal Yoke Design for 2- and 3-Bolt Applications
- Hardened and Tempered, Precision-Machined Center Bolt with Three Tip Adapters
- Multi-Purpose Puller Applies Pressure to Hub to Safely Remove Harmonic Balances, Crankshaft Pulleys, and Steering Wheels
- 1-pc. Yoke
- 1-pc. Center Screw
- 3-pc. Center Screw Tip Adapters
- 3-pc. 3/8" (24 TPI) x 1-1/2" Puller Bolts
- 3-pc. 3/8" (16 TPI) x 2" Puller Bolts
- 3-pc. 3/8" (16 TPI) x 3" Puller Bolts
- 2-pc. 3/8" (16 TPI) x 4-1/2" Puller Bolts
- 2-pc. 5/16" (18 TPI) x 6" Puller Bolts
- 3-pc. 5/16" (18 TPI) x 3-1/2" Puller Bolts
- 2-pc. 5/16" (24 TPI) x 3" Puller Bolts
- 3-pc. 5/16" Washers
- 2-pc. 1/4" (28 TPI) x 2-1/2" Puller Bolts
- 2-pc. 1/4" Washers
- 3-pc. M10 (1.5mm) x 35mm Puller Bolts
- 3-pc. 10mm Washers
- 3-pc. M8 (1.25mm) x 45mm Puller Bolts
- 2-pc. M8 (1.25mm) x 65mm Puller Bolts
- 2-pc. M8 (1.25mm) x 90mm Puller Bolts
- 3-pc. 8mm Washers

Item	Description	Packaging	Cs	In
5755	46-pc. Harmonic Balance Puller	Sealed Blister	12	6



Single-Action Internal Coil Spring Compressor

- Forged and Hardened Chrome Vanadium Steel Arms
- Cold-Rolled, Fine-Thread Steel Center Screw
- Corrosion-Resistant Black Oxide Finish
- Internally Mounted Compressor for Springs that can be Reached Through Center of Coil

Specifications:

- Max. Spring Capacity: 5-5/8" O.D. x 3/4" Wire Diameter
- Overall Length: 11-1/2"
- Wrench Needed: 15/16" (23mm)

Item	Description	Packaging	Cs	In
5734	Single-Action Internal Coil Spring Compressor	Slide Blister Card	12	3



Coil Spring Compressor Set

- Heavy Duty Cast Steel Arms
- Precision-Machined Hardened Steel Center Screws
- Compresses Coil Spring Allowing Removal from MacPherson Strut Assembly
- Fits Most Common Spring Sizes

Item	Description	Packaging	Cs	In
5737	Coil Spring Compressor Set	Color Box	12	1

Battery Post and Terminal Brush

- Tough Stainless Steel Brushes
- Steel Housing with Durable Nickel Plated Finish
- Internal Brush Cleans Battery Posts, Cone Brush Cleans Battery Terminals
- Removes Dirt, Debris and Corrosion to Restore Electrical Contact



Item	Description	Packaging	Cs	In
5780	Battery Post and Terminal Brush	Slide Blister Card	288	12



12 V Continuity Tester

- Tests 6-12 VDC Automotive and Small Equipment Electrical Systems
- Checks Circuit Continuity and Identifies Blown Fuses or Light Bulbs
- Sharp Steel Probe Reaches into Fuse Boxes or Pierces Insulation to Contact Wire
- Indicator Light in Handle Glows when Circuit is Completed
- 54" Heavy Duty Test Lead with Alligator Clip

Item	Description	Packaging	Cs	In
5891	12 V Continuity Tester	Slide Blister Card	72	6



12 V Continuity Tester

- Tests 6-12 VDC Automotive and Small Equipment Electrical Systems
- Checks Circuit Continuity and Identifies Blown Fuses or Light Bulbs
- Sharp Steel Probe Reaches into Fuse Boxes or Pierces Insulation to Contact Wire
- Indicator Light in Handle Glows when Circuit is Completed
- 24" Test Lead with Alligator Clip

Item	Description	Packaging	Cs	In
5892	12 V Continuity Tester	Slide Blister Card	120	12



12 V In-Line Spark Tester

- Simple In-line Connection Between Spark Plug Wire and Spark Plug
- Tests for Continuity of Ignition Circuit
- Indicator Light Flashes when Ignition Circuit is Complete
- Test Range: 6 - 12 VDC

Item	Description	Packaging	Cs	In
5889	12 V In-Line Spark Tester	Slide Blister Card	72	6



15-pc. Auto Fuse Set

- Six Most Common Fuse Sizes
- Chip-Type Fuses Meet or Exceed OEM Specifications
- Color Coded for Easy Identification
- Keep in Glove Box for Fast, Easy, Economical Repairs

- 2-pc. 5 AMPS
- 3-pc. 10 AMPS
- 3-pc. 15 AMPS
- 3-pc. 20 AMPS
- 2-pc. 25 AMPS
- 2-pc. 30 AMPS

Item	Description	Packaging	Cs	In
6066	15-pc. Auto Fuse Set	Slide Blister Card	300	10



Disc Brake Pad Spreader

- Large, Comfortable 4-Flute Poly Handle
- Rugged 5/32" Steel Spreader Plate
- Zinc-Plated Steel Center Screw and Swivel Foot
- Compresses Disc Brake Caliper Piston to Allow New Pad Installation

Item	Description	Packaging	Cs	In
5806	Disc Brake Pad Spreader	Slide Blister Card	48	6



5-in-1 3/8" Drive Disc Brake Piston Retractor

- Heat Treated Chrome Plated Die Cast Zinc
- Rotates Caliper Piston Back into Bore on Actuator-Screw Rear Disc Brakes to Allow New Pad Installation
- Universal 5-in-1 Cube Design Fits Most Piston Lug Patterns
- 3/8" Drive

Item	Description	Packaging	Cs	In
5807	5-in-1 3/8" Drive Disc Brake Piston Retractor	Slide Blister Card	72	6



7-pc. One-Person Brake Bleeder Kit

- Complete hands-free kit allows one person to bleed brake system without assistance
- Lightweight, sealable collection bottle with magnet mounts to vehicle frame
- Universal design works with nearly all passenger vehicle hydraulic brake calipers and wheel cylinders

Item	Description	Packaging	Cs	In
5808	7-pc. One-Person Brake Bleeder Kit	Slide Blister Card	72	6



12" Brake Spring Pliers

- Rugged Heat Treated Steel Construction
- Corrosion-Resistant Chrome Plated Finish
- All-in-One Drum Brake Spring Tool Removes and Installs Retaining, Return, and Hold-Down Springs

Item	Description	Packaging	Cs	In
5810	12" Brake Spring Pliers	Slide Blister Card	48	6



7-pc. Drum Brake Tool Set

- Complete Assortment of Common Drum Brake Repair Tools
- Forged, Heat Treated Carbon Steel
- Corrosion-Resistant Chrome Plated Finish
- Precision-Machined 6-Point Box End Wrenches
- 1-pc. Retainer Spring Tool
- 1-pc. Brake Spring/Clip Tool
- 3-pc. Double-Box-End Bleeder Wrenches (6-Point): 1/4" x 3/8", 5/16" x 3/8", 90° 8mm x 10mm
- 2-pc. Brake Shoe Adjuster Tools

Item	Description	Packaging	Cs	In
5820	7-pc. Drum Brake Tool Set	Color Box	20	1

Universal Chain Oil Filter Wrench

- Fully Adjustable Universal Chain Design Fits Any Diameter Oil Filter up to 5"
- Applies a Non-Slip Grip to Remove Even Difficult Filters
- Compact Construction is Ideal for Cramped Engine Compartments
- Comfortable Cushioned Handle Grip



Item	Description	Packaging	Cs	In
5862	Universal Chain Oil Filter Wrench	Slide Blister Card	72	6



Filter Claw Oil Filter Pliers

- Drop Forged, Heat Treated Steel with Rust-Resistant Finish
- Aggressive Teeth Grip Even Greasy or Oil-Covered Filters
- Non-Slip Cushioned Handles
- 3-Position Slip Joint Hinge Adjusts to Fit Oil Filter Sizes up to 4-1/2"

Item #	Max. Filter Size
5866	4-1/2"
5867	5-1/2"

Item	Description	Packaging	Cs	In
5866	12" Oil Filter Pliers	Slide Blister Card	48	6
5867	16" Oil Filter Pliers	Slide Blister Card	24	6



3-3/4" Flex Oil Filter Wrench

- Rugged Hardened Steel Handle and Flex Head
- Non-Slip Cushioned Handle Grip
- 180° Flex Head for Access in Tight Engine Compartments
- Automatically Adjusts to Fit Oil Filter Sizes 3-1/4" to 3-3/4" Diameter

Item	Description	Packaging	Cs	In
5868	3-3/4" Flex Oil Filter Wrench	Hang Card	72	6

4-pc. Funnel Set

- Lightweight Polyethylene Construction
 - Bright Red Color is Easy to Locate in Work Area
 - Use for Oil, Coolant, Gasoline, Kerosene, and other Fluids
- 4-pc. Funnel Set: 2" (2 fl. oz.), 3" (3 fl. oz.) 4" (7 fl. oz.), 5" (13 fl. oz.)



Item	Description	Packaging	Cs	In
6093	4-pc. Funnel Set	Color Label	36	6

2-in-1 Funnel with Flex Extension (40 oz.)

- Chemical-Resistant Polyethylene Construction
- Mesh Screen Filters Out Damaging Particles
- Use for Engine Oil, Coolant, Gasoline, Kerosene, Engine Fluids, etc.
- Side Mounted Handle for Better Grip
- 2-in-1 Deluxe Funnel: 7-1/2" Funnel with Removable 8" Flexible Extension
- 40 fl. oz. Capacity



Item	Description	Packaging	Cs	In
6094	2-in-1 Funnel with Flex Extension (40 oz.)	Color Label	36	6



Seal Puller

- Heat Treated Double-End Steel Head with Two Tip Sizes
- Black Oxide Finish Resists Corrosion
- Nickel Plated Tubular Steel Shaft
- Oversized Mechanic-Style Handle
- Removes Worn Grease and Oil Seals

Item	Description	Packaging	Cs	In
5741	Seal Puller	Sealed Blister	48	6



2-pc. Distributor Wrench Set

- Forged and Hardened Carbon Steel
- Corrosion-Resistant Chrome Plated Finish
- Offset Design Easily Reaches Distributor Lock Nut
- 3/8" Drive Ratchet Adapter
- Wrench Sizes: 9/16" and 1/2"

Item	Description	Packaging	Cs	In
5850	2-pc. Distributor Wrench Set	Slide Blister Card	48	6



Parts Cleaning Brush

- Heavy Duty Nylon Bristles
- Tapered Natural Hardwood Handle
- 10-1/2" Overall Length

Item	Description	Packaging	Cs	In
5880	Parts Cleaning Brush	Hang Card	36	12



Mechanic's Stethoscope

- Comfortable, Spring-Return Ear Pieces Stay in Place
- Aluminum and Flexible Vinyl Tubing Construction
- 4" Steel Probe with 8" Extension
- Locate Trouble Spots within Engine Block

Item	Description	Packaging	Cs	In
5888	Mechanic's Stethoscope	Slide Blister Card	48	6



4-pc. Mini Pick and Hook Set

- Heat Treated, Chrome Vanadium Steel Shafts
- Knurled Grip Section on Shaft for Precise Control
- Comfortable Handles with Non-Slip Rubber Grips
- Swivel End Cap Allows Constant Finger Pressure while Turning or Positioning
- 1-pc. Full Hook
- 1-pc. 45-degree
- 1-pc. 90-degree
- 1-pc. Straight Pick

Item	Description	Packaging	Cs	In
6941	4-pc. Mini Pick and Hook Set	Sealed Blister	72	12

4-pc. Precision Pick and Hook Set

- Heat Treated, Chrome Vanadium Steel Shafts
- Cushioned, Non-Slip Grips for Extra Control
- Knurled Shaft Grip Area for Precise Work
- Ideal For Assembly, Repair, or Removal of Small Parts
- 1-pc. Full Hook
- 1-pc. 45-degree
- 1-pc. 90-degree
- 1-pc. Straight Pick

Item	Description	Packaging	Cs	In
6943	4-pc. Precision Pick and Hook Set	Sealed Blister	72	6

12" Long Reach Scraper

- Rugged Steel Blade Holder
- Strong Tubular Steel Shaft
- High-Impact Clear Handle with Blade Storage Compartment
- Extra Long 12" Length Reaches into Tight Spots
- Removes Decals, Tape, and Adhesive Residue from Windows and Mirrors
- 1-pc. Scraper
- 3-pc. Scraper Blades

Item	Description	Packaging	Cs	In
5878	12" Long Reach Scraper	Slide Blister Card	72	6



Gasket Scraper

- Drop Forged, Heat Treated Carbon Steel
- Rugged Square 3/8" Stock Shaft
- Black Oxide Finish Resists Corrosion
- Comfortable Contoured Handle
- 1" Wide Blade Scrapes Mating Surfaces Clean for Installing New Gaskets

Item	Description	Packaging	Cs	In
5876	Gasket Scraper	Slide Blister Card	72	6



5-pc. Professional Scraper and Remover Set

- Drop Forged, Heat Treated Steel Shafts
- Precision Formed and Ground Blade Tips
- Scrapers Feature 1" Wide, Beveled-Edge Blades
- Corrosion-Resistant Black Oxide Finish
- Large Mechanic's-Style Square Handles for a Sure Grip
- 1-pc. 9" Cotter Pin Puller
- 1-pc. 8" Scratch Awl
- 1-pc. 7" Radiator Hose Remover
- 1-pc. 11" Multi-Purpose Scraper
- 1-pc. 8-1/2" Multi-Purpose Scraper

Item	Description	Packaging	Cs	In
6945	5-pc. Professional Scraper and Remover Set	Sealed Blister	20	5





5930

59301

- AVAILABLE IN DISPLAY QUANTITIES ONLY



Pencil Tire Gauges - 100 PSI

- Calibrated from 10 - 100 PSI
- 45° Angled Chuck with Valve Depressor
- Spring Pocket Clip
- Save Gas and Tire Wear with Proper Inflation

Item	Description	Packaging	Cs	In
5930	Pencil Tire Gauge - 100 PSI	Slide Blister Card	250	10
59301	Pencil Tire Gauge - 100 PSI	UPC Label/Fishbowl	288	72



Pencil Tire Gauge - 120 PSI

- Calibrated from 10 - 120 PSI
- Durable Chrome Plated Metal Housing
- 45° Angled Dual Foot Chuck
- Spring Pocket Clip
- Save Gas and Tire Wear with Proper Inflation

Item	Description	Packaging	Cs	In
5940	Pencil Tire Gauge - 120 PSI	Slide Blister Card	240	12



Dial Tire Gauge - 50 PSI

- Calibrated from 5 - 50 PSI
- Impact-Resistant ABS Housing
- Easy-Read High-Contrast Dial Face
- Holds Dial Reading until Reset Button is Pressed
- 45° Angled Chuck with Valve Depressor
- Save Gas and Tire Wear with Proper Inflation

Item	Description	Packaging	Cs	In
5935	Dial Tire Gauge - 50 PSI	Slide Blister Card	250	10



Dial Tire Gauge - 100 PSI

- Calibrated from 10 - 100 PSI
- Durable Metal Housing with Black Enamel Finish
- Easy-Read High-Contrast Dial Face
- Holds Dial Reading until Reset Button is Pressed
- 45° Angled Chuck with Valve Depressor
- Save Gas and Tire Wear with Proper Inflation

Item	Description	Packaging	Cs	In
5938	Dial Tire Gauge - 100 PSI	Slide Blister Card	150	10



Digital Tire Gauge - 100 PSI

- Lighted Nozzle and Display for Easy Measurements
- Push-Button On/Range Selector with Auto Shut-Off
- Non-Slip Ergonomic Pistol Grip Design

Specifications:

Measurement Ranges (4):

PSI: 0 - 100, Bar: 0 - 7, KPA: 0-700, Kg/cm2: 0-7

Min. Increment: 0.5 PSI

Battery: One CR2032 3V Lithium Coin Cell (Included)

Item	Description	Packaging	Cs	In
5941	Digital Tire Gauge - 100 PSI	Slide Blister Card	72	6

Brass Tire Chucks

5950

- Solid Brass Construction
- Precision-Machined for Leak-Proof Operation
- 45° Angled Head
- Air Inlet: 1/4" NPT

5952

- Solid Brass Construction
- Precision-Machined for Leak-Proof Operation
- 45° Angled Head
- Lever Locks Chuck to Valve Stem
- Air Inlet: 1/4" NPT



Item	Description	Packaging	Cs	In
5950	Brass Tire Chuck	Slide Blister Card	250	10
5952	Brass Tire Chuck with Lever Lock	Slide Blister Card	200	10



Dual Tire Chuck

- Precision Zinc-Cast Construction
- Offset Dual Chuck Allows Easy Access to Valve Stems
- Female 1/4" NPT
- 6" Overall Length

Item	Description	Packaging	Cs	In
5955	Dual Tire Chuck	Slide Blister Card	100	10



18-pc. Tire Plug Repair Kit

- All-in-One Kit with Everything you Need to Repair Puncture-Damaged Tires
- Heavy Duty, Solid Steel T-Handle with Durable Chrome Plated Finish
- Precision-Machined Interchangeable Steel Rasp and Open Eye Tools
- 1-pc. T-Handle
- 1-pc. Rasp Tool
- 1-pc. Open Eye Tool
- 1-pc. Hex Key
- 1-pc. Plug Strip Cutter
- 12-pc. Tire Plug Strips
- 1-pc. Rubber Cement

Item	Description	Packaging	Cs	In
5962	18-pc. Tire Plug Repair Kit	Slide Blister Card	48	6

20" Tire Pump

- Rugged Steel Cylinder
- Non-Slip Soft Grip T-Handle
- Solid Cast Base with Fold Down Foot Pegs for Stable Operation
- Lever Locks Chuck to Valve Stem
- 21" Air Hose
- Three Nozzle Adapters for Inflating Bicycle Tires, Toys, Sporting Equipment and Air Mattresses

Item	Description	Packaging	Cs	In
6092	20" Tire Pump	Sealed Blister	12	1

120 PSI Tire Inflator with Gauge

- Cast Aluminum Alloy Body with Brass Valve
- 12" Flexible, Industrial-Grade Rubber Hose
- 6" Tire Chuck with 45° Angled Dual Foot
- Built-in 120 PSI Pressure Gauge

Specifications:

- Air Inlet (F): 1/4" NPT
- Maximum Air Pressure: 120 PSI
- Pressure Gauge: 10-120 PSI



Item	Description	Packaging	Cs	In
5960	120 PSI Tire Inflator with Gauge	Slide Blister Card	25	5

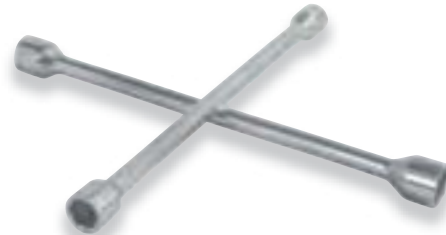

4-Way Lug Wrenches

5974

- Forged Heat Treated Steel
- Rugged Welded Cross Design for Two-Handed Torque
- Chrome Plated Finish Resists Corrosion
- 6-Point Wrenches (MM): 17, 19, 21, and 23mm

5975

- Forged Heat Treated Steel
- Rugged Welded Cross Design for Two-Handed Torque
- Chrome Plated Finish Resists Corrosion
- 6-Point Wrenches (SAE/MM): 3/4", 13/16", 7/8", and 19mm

Item	Description	Packaging	Cs	In
5974	14" 4-Way Lug Wrench	Plastic Hang Tab/Label	12	3
5975	20" 4-Way Lug Wrench	Plastic Hang Tab/Label	12	3





5495

Hydraulic Bottle Jacks

- Rugged All-Steel Construction
- Hardened, Machined and Polished Ram and Plunger for Smooth Operation
- Screw Top Extends and Precisely Adjusts Lifting Height
- Strong and Stable One-Piece Cast Steel Base
- Two-Piece Pump Handle for Use in Tight Spaces and Compact Storage
- Rust-Free Enamel Finish
- Conforms to ASME Standards for Safety and Performance of Portable Automotive Lifting Devices

Item #	Lifting Capacity	Min. Clearance	Adjustable Screw	Max. Lifting Height
5470	4000 lb. (1818 kg)	7-1/4" (18.4 cm)	2" (5 cm)	13-7/8" (35.25 cm)
5475	8000 lb. (3636 kg)	7-3/4" (19.5 cm)	2-3/8" (6 cm)	15-1/8" (38.5 cm)
5480	12000 lb. (5454 kg)	8-1/2" (21.5 cm)	2-3/4" (7 cm)	17-1/4" (43.8 cm)
5485	16000 lb. (7272 kg)	9" (23.8 cm)	3-7/8" (9.8 cm)	18-3/4" (47.5 cm)
5490	24000 lb. (10910 kg)	9-1/4" (23.5 cm)	3-1/4" (8.25 cm)	18-5/8" (47.3 cm)
5495	40000 lb. (18180 kg)	9-1/2" (24 cm)	2-3/8" (6 cm)	18-1/8" (46 cm)
5496	40000 lb. (18180 kg)	7-1/2" (19 cm)	2-3/8" (6 cm)	14-1/4" (36 cm)



5496

Item	Description	Packaging	Cs	In
5470	2 Ton Hydraulic Bottle Jack	Color Box	6	1
5475	4 Ton Hydraulic Bottle Jack	Color Box	6	1
5480	6 Ton Hydraulic Bottle Jack	Color Box	4	1
5485	8 Ton Hydraulic Bottle Jack	Color Box	4	1
5490	12 Ton Hydraulic Bottle Jack	Color Box	3	1
5495	20 Ton Hydraulic Bottle Jack	Color Box	2	1
5496	20 Ton Hydraulic Bottle Jack - Low Profile	Color Box	2	1



2-1/4 Ton Floor Jack

- Heavy Duty, All-Steel Construction with Corrosion-Resistant Enamel Finish
- Lifting Saddle Swivels 360° to Engage and Fit Lifting Area Properly
- Solid Steel Casters on Front (3-1/2") and Rear (2" Swivel Ball Bearing)
- Adjustable, Handle-Controlled Lifting and Lowering Provides Full Control of Load
- 2-Piece Handle with Non-Slip, Rubber Grip
- Conforms to ASME PALD Safety Standards

Specifications:

- Overall Dimensions: 26" L x 13-1/4" W
- Saddle: 5" Dia., Swivel
- Handle Length: 43"

Lifting Capacity	Minimum Clearance	Lifting Distance	Max. Lift Height	Weight
2-1/4 Tons (4,500 lb.)	5"	14-1/4"	19-1/4"	75 lb.

Item	Description	Packaging	Cs	In
5510	2-1/4 Ton Floor Jack	Color Box	1	1

Rope Hoist

- Easily and Safely Lifts Heavy Loads with Less Effort
- Twisted Braid Poly Rope will not Rot or Shrink
- Weather-Resistant Zinc Plated Steel Pulleys and Hooks for Indoor/ Outdoor Use
- Smooth-Rolling Poly Wheels
- Compact, Lightweight, Portable Design fits in Cargo Pocket or Backpack
- Use for Camping, Hunting, Light Construction and Storage Applications

Specifications:

- 500 lb. Lifting Capacity
- 13 ft. Max. Lifting Height
- 65 ft. Twisted Braid Poly Rope

Item	Description	Packaging	Cs	In
5550	Rope Hoist	Sealed Blister	40	10



Power Pullers

- Powerful Ratcheting System Pulls Heavy Loads with Less Effort
- Use for Construction, Landscaping, Loading/Unloading, and Farm Applications
- Hardened All-Steel Construction with Corrosion-Resistant Galvanized Finish
- Laminated Steel Gear and Locking Pawl
- High-Tensile-Strength Aircraft-Grade Braided Steel Cable
- Drop Forged Self-Closing Safety Catch Hooks
- High-Leverage Ratchet Handle with Cushioned Non-Slip Grip
- Automatic Notch-at-a-Time Tension Letdown

Item #	Max. Capacity/ Safe Work Load	Hook Size	Cable Size	Handle Length	Max. Pull Length
5541	4,000 lb./2,000 lb.	3/8"	13' x 3/16"	17-1/2"	7' 10"
5546	8,000 lb./4,000 lb.	5/16"	12' x 7/32"	21"	7' 3"

Item	Description	Packaging	Cs	In
5541	2-Ton Power Puller	Color Box	6	1
5546	4-Ton Power Puller	Color Box	4	1



5541

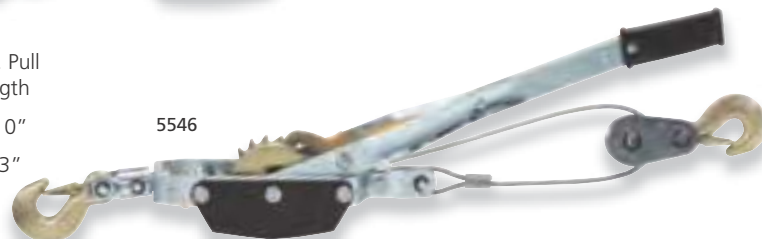

5546

Dual Gear Power Pullers

- Powerful Ratcheting System Pulls Heavy Loads with Less Effort
- Use for Construction, Heavy Equipment, Loading/Unloading, and Farm Applications
- Heavy Gauge All-Steel Construction with Corrosion-Resistant Galvanized Finish
- Dual Solid Steel Gears and Locking Pawls Distribute Pulling Force Evenly
- Rugged One Piece Frame Design
- High-Tensile-Strength Aircraft-Grade Braided Steel Cable
- Drop Forged Self-Closing Safety Catch Hooks
- High-Leverage Ratchet Handle with Cushioned Non-Slip Grip
- Automatic Notch-at-a-Time Tension Letdown

Item #	Max. Capacity/ Safe Work Load	Hook Size	Cable Size	Handle Length	Max. Pull Length
5542	4,000 lb./2,000 lb.	3/8"	12' x 3/16"	17"	7' 3"
5547	Single Line: 4,000 lb. /2,000 lb. Double Line: 8,000 lb. /4,000 lb.	5/16"	12' x 1/4"	20"	7' 3" / 12' 7"

Item	Description	Packaging	Cs	In
5542	2-Ton Dual Gear Power Puller	Color Box	6	1
5547	4-Ton Dual Gear Power Puller	Color Box	4	1



5542



5547



Hitch Balls

- Drop Forged Carbon Steel Construction
- Durable Chrome Plated Finish Resists Rust and Corrosion
- Precision-Machined Bolt with Lock Washer and Nut
- Fits Standard Hitch Coupler

Item #	Ball Diameter	Bolt Diameter	Bolt Length	Towing Capacity
6069	1-7/8"	1"	2-1/2"	2000 Lb.
6070	1-7/8"	3/4"	1-3/4"	2000 Lb.
6072	1-7/8"	3/4"	2-1/2"	2000 Lb.
6075	2"	3/4"	1-3/4"	3500 Lb.
6077	2"	3/4"	2-1/2"	3500 Lb.
6078	2"	1"	2-1/2"	5000 Lb.
6080	2-5/16"	1"	2-1/2"	5000 Lb.

Item	Description	Packaging	Cs	In
6069	1-7/8" Hitch Ball	Plastic Hang Rack/Label	24	1
6070	1-7/8" Hitch Ball	Plastic Hang Rack/Label	24	1
6072	1-7/8" Hitch Ball	Plastic Hang Rack/Label	24	1
6075	2" Hitch Ball	Plastic Hang Rack/Label	24	1
6077	2" Hitch Ball	Plastic Hang Rack/Label	24	1
6078	2" Hitch Ball	Plastic Hang Rack/Label	24	1
6080	2-5/16" Hitch Ball	Plastic Hang Rack/Label	15	1



Hitch Ball Couplers

- Drop Forged, Heat Treated Flanged Steel Construction
- Sturdy, Riveted Tongue Lock with Spring Release
- Use with Industrial, Commercial, Utility Agricultural, and Recreational Equipment

Item #	Hitch Ball Dia.	Tongue Width	Class	Towing Capacity
6084	1-7/8"	2-1/2"	I	2,000 Lb.
6086	2"	2-1/2"	II	3,500 Lb.
6087	2"	3"	II	3,500 Lb.
6088	2"	2"	II	3,500 Lb.

Item	Description	Packaging	Cs	In
6084	1-7/8" x 2-1/2" Hitch Ball Coupler	Color Label	12	1
6086	2" x 2-1/2" Hitch Ball Coupler	Color Label	12	1
6087	2" x 3" Hitch Ball Coupler	Color Label	12	1
6088	2" x 2" Hitch Ball Coupler	Color Label	12	1

Hitch Receiver Pins

- Secures Ball Hitch into Receiver
- Solid Steel Pin and Locking Clip
- Weather-Resistant Zinc-Plated Finish

Item #	Hitch Receiver Size	Hitch Receiver Class	Shear Strength	Dimensions	Straight Length
6016	1-1/4"	Class I and II	20,000 Lb.	1/2" x 5"	3"
6017	2"	Class III and IV	30,000 Lb.	5/8" x 5-1/2"	3-1/4"

Item	Description	Packaging	Cs	In
6016	1/2" Hitch Receiver Pin	Slide Blister Card	96	12
6017	5/8" Hitch Receiver Pin	Slide Blister Card	96	12



Locking Hitch Receiver Pins

- Secures Ball Hitch into Receiver
- Rugged Theft-Resistant Deadbolt Lock
- Dust Cover Keeps Out Water and Dirt
- Solid Steel Pin with Weather-Resistant Chrome-Plated Finish

Item #	Hitch Receiver Size	Hitch Receiver Class	Shear Strength	Dimensions	Straight Length
6018	1-1/4"	Class I and II	20,000 Lb.	1/2" x 6-1/2"	3"
6019	2"	Class III and IV	30,000 Lb.	5/8" x 7"	3-1/2"

Item	Description	Packaging	Cs	In
6018	1/2" Locking Hitch Receiver Pin	Sealed Blister	48	12
6019	5/8" Locking Hitch Receiver Pin	Sealed Blister	48	12



1/4" Coupler Safety Pin

- Universal Fit for any Hitch Ball Coupler Using 1/4" Pin
- Fits Through Latch Release Handle to Prevent Accidental Opening
- Rugged Steel Pin with Spring Steel Safety Clip
- Weather-Resistant Zinc Plated Finish
- 1/4" Diameter, 2-1/2" Usable Length (3" Overall Length)

Item	Description	Packaging	Cs	In
6020	1/4" Coupler Safety Pin	Slide Blister Card	144	12





Hand Winches

- 1200-Lb. Pulling Capacity
- Zinc Plated Heavy Gauge Steel Construction
- Smooth-Action, Single Speed Ratcheting Crank with 4:1 Gear Ratio Generates Extra Pulling Power with Less Effort
- Ideal for Trailering/Loading Applications: Boats, Personal Watercraft, Lawn Equipment, Etc.
- Extra Long 9" Handle for Easier Operation
- Comfortable Handle Grip Reduces Fatigue
- 3-Position Locking Pawl Allows Forward and Reverse Ratcheting Action
- Drop Forged Safety Catch Hooks

Item #	Cable Size	Cable Style	Cs	In
5552	3/16" x 65'	Steel Cable	6	1
5553	2" x 33'	Poly Strap	6	1

Item	Description	Packaging	Cs	In
5552	1200-lb. Hand Winch (Cable)	Color Box	6	1
5553	1200-lb. Hand Winch (Strap)	Color Box	6	1



Trailer Jacks

- 6081**
- Adjusts Trailer Tongue Height for Easy Hitching/Unhitching
 - Supports Parked or Stored Trailers
 - Rugged All-Steel Construction
 - Enamel and Zinc-Plated Finish Resists Weather and Corrosion
 - Quick-Release, Spring-Return Pin Locks Jack in Vertical and 90° Positions
 - 3/16" Swivel Mounting Plate Welds Directly to Trailer Tongue

- 6083**
- Adjusts Trailer Tongue Height for Easy Hitching/Unhitching
 - Provides Support and Safe, Easy Moving of Parked or Stored Trailers
 - Rugged All-Steel Construction
 - Zinc-Plated Finish Resists Weather and Corrosion
 - Quick-Release, Spring-Return Pin Locks Jack in Vertical and 90° Positions
 - Heavy Duty 360° Swivel Caster
 - 3/16", 4-Bolt Swivel Mounting Plate
 - Includes All Mounting Hardware

Item #	Max. Lift Height	Min. Height	Lift Range	Capacity
6081	23-1/2"	13-1/4"	10-1/4"	2000 Lb.
6083	21"	12"	9"	1000 Lb.

Item	Description	Packaging	Cs	In
6081	2000-lb. Trailer Jack	Color Box	4	1
6083	1000-lb. Trailer Jack	Color Box	4	1

14' x 3/4" Poly Tow Rope

- Rugged, Lightweight, Braided Poly Rope
- Weather-Resistant Polypropylene / Polyethylene Material will not Mildew, Rot, or Shrink
- Forged and Heat Treated Carbon Steel Safety Catch Hooks
- End-Guards Protect Rope and Prevent Scratching Damage to Attachment Point
- Ideal Roadside Emergency Tow Rope - Lighter and Easier to Use than Chains
- 2,000 Lb. Working Load Limit
- 6,000 Lb. Maximum Breaking Strength



Item	Description	Packaging	Cs	In
6000	14' x 3/4" Poly Tow Rope	Sealed Blister	20	10

Flat Tow Straps

- Non-Stretching Woven Polyester Construction Performs Better than Nylon, Applying a Safer, More Consistent Pulling Force
- Weather-Resistant Strap will not Mildew, Rot, or Shrink
- Forged and Heat Treated Carbon Steel Safety Catch Hooks
- End Guards Protect Strap and Prevent Scratching Damage to Attachment Point



Item #	Length	Width	Working Load Limit	Max. Break Strength
6005	14'	2"	2,000 Lb.	6,000 Lb.
6015	20'	2-1/4"	3,500 Lb.	10,500 Lb.

Item	Description	Packaging	Cs	In
6005	14' x 2" Flat Tow Strap	Sealed Blister	20	10
6015	20' x 2-1/4" Flat Tow Strap	Sealed Blister	10	1

Heavy Duty Recovery Straps

- Abrasion and Weather-Resistant Polyester Web Strap
- Looped Ends for Maximum Strength and Versatility



Item #	Length	Width	Working Load Limit	Max. Break Strength
6225	30'	4"	6,600 Lb.	20,000 Lb.
62251	30'	3"	5,400 Lb.	16,200 Lb.

Item	Description	Packaging	Cs	In
6225	30' x 4" Recovery Strap	Wrap Card/Display Box	8	4
62251	30' x 3" Recovery Strap	Wrap Card/Display Box	10	5





2600 lb. Load Binder

- 9" Cast Steel I-Beam Handle
- Forged Steel Hooks
- Weather-Resistant Baked Enamel Finish
- Applies High Tension with Less Effort
- Use with 1/4" - 5/16" Chain Size
- 2,600 lb. Working Load Limit
- 7,800 lb. Maximum Breaking Strength

Item	Description	Packaging	Cs	In
5534	2600 lb. Load Binder	Wrap or Tie Card	12	1



5400 lb. Load Binder

- 13" Cast Steel I-Beam Handle
- Forged Steel Hooks
- Weather-Resistant Baked Enamel Finish
- Applies High Tension with Less Effort
- Use with 5/16" - 3/8" Chain Size
- 5,400 lb. Working Load Limit
- 19,000 lb. Maximum Breaking Strength

Item	Description	Packaging	Cs	In
5535	5400 lb. Load Binder	Wrap or Tie Card	6	1



5400 lb. Ratchet Load Binder

- 13" Cast Steel I-Beam Handle
- 15-Tooth, Single Pawl Ratchet
- Forged Steel Hooks
- Weather-Resistant Baked Enamel Finish
- Applies High Tension with Less Effort
- Use with 5/16" - 3/8" Chain Size
- 5,400 lb. Working Load Limit
- 19,000 lb. Maximum Breaking Strength

Item	Description	Packaging	Cs	In
5536	5400 lb. Ratchet Load Binder	Wrap or Tie Card	4	2



9200 lb. Load Binder

- 15" Cast Steel I-Beam Handle
- Forged Steel Hooks
- Weather-Resistant Baked Enamel Finish
- Applies High Tension with Less Effort
- Use with 3/8" - 1/2" Chain Size
- 9,200 lb. Working Load Limit
- 28,000 lb. Maximum Breaking Strength

Item	Description	Packaging	Cs	In
5538	9200 lb. Load Binder	Wrap or Tie Card	4	1

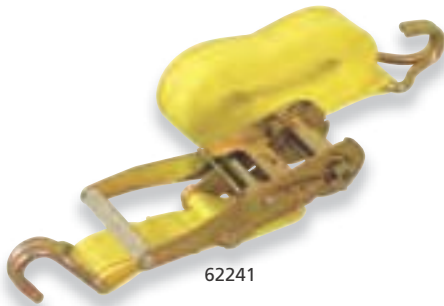

62241

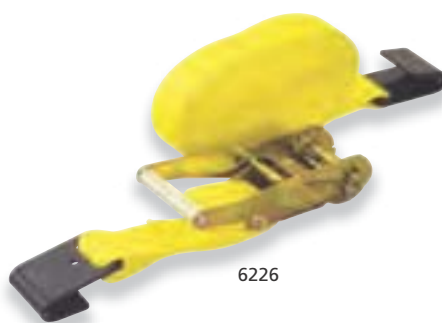

62226

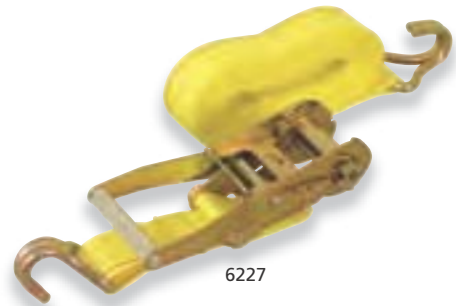

62227

Heavy Duty Ratchet Tie Downs

- Abrasion and Weather-Resistant Polyester Web Strap
- Heat Treated Steel "J"-Hooks
- Dual-Gear Ratchet Applies More Tension with Less Effort
- Quick-Release Dual Pawls Stay Locked and Maintain Tension During Transit
- Meets WSTDA-T-1 Standard Specification as Required by FMCSA Cargo Securement Rules

Item	Description	Packaging	Cs	In
62241	25' x 2" Ratchet Tie Down	Wrap Card/Display Box	6	3
62226	30' x 2" Ratchet Tie Down	Wrap Card/Display Box	6	3
62227	30' x 2" Ratchet Tie Down	Wrap Card/Display Box	6	3

Item #	Size	Hook Style	Working Load Limit	Max. Break Strength
62241	25' x 2"	"J"-Hook	1,650 Lb.	5,000 Lb.
62226	30' x 2"	Flat Hook	3,333 Lb.	10,000 Lb.
62227	30' x 2"	"J"-Hook	3,333 Lb.	10,000 Lb.

• AVAILABLE IN DISPLAY QUANTITIES

- 62241
- 62226
- 62227





15' x 1" Premium Ratchet Tie Down Sets

- Weather-Resistant, Woven Polyester Strap
- Dual-Gear Ratchet with Cushioned, Non-Slip Handle Grip Applies More Tension with Less Effort
- One-Touch, Quick-Release Dual Pawls Stay Locked and Maintain Tension During Transit
- Steel "S"-Hooks are Double-Vinyl Coated to Prevent Scratches
- Use to Secure Cargo on Trucks and Trailers
- 500 lb. Working Load Limit
- 1,500 lb. Maximum Breaking Strength

Item	Description	Packaging	Cs	In
6220	2-pc. 15' x 1" Premium Ratchet Tie Downs	Plastic Hang Rack/Label	12	4
6223	4-pc. 15' x 1" Premium Ratchet Tie Downs	Plastic Hang Rack/Label	8	4



5' Cam Buckle Tie Down

- Weather-Resistant, Woven Polyester Strap
- Rugged, Quick-Release, Auto-Locking Cam Buckle
- Hardened, Corrosion-Resistant Steel J-Hooks
- Use to Secure Light Cargo in Trucks or Vans
- 120 lb. Working Load Limit
- 360 lb. Maximum Breaking Strength

Item	Description	Packaging	Cs	In
6215	5' Cam Buckle Tie Down	Sealed Blister	72	6



15' x 1" Ratchet Tie Down Sets

- Weather-Resistant, Woven Polypropylene Strap
- Dual-Gear Ratchet Applies More Tension with Less Effort
- Quick-Release Dual Pawls Stay Locked and Maintain Tension During Transit
- Steel "S"-Hooks are Double-Vinyl Coated to Prevent Scratches
- Use to Secure Cargo on Trucks and Trailers
- 333 lb. Working Load Limit
- 1,000 lb. Maximum Breaking Strength

Item	Description	Packaging	Cs	In
6218	2-pc. 15' x 1" Ratchet Tie Downs	Plastic Hang Rack/Label	12	4
6219	4-pc. 15' x 1" Ratchet Tie Downs	Plastic Hang Rack/Label	8	4

Cam Buckle Tie Downs

- Weather-Resistant, Woven Polypropylene Strap
- Rugged, Quick-Release, Auto-Locking Cam Buckle
- Steel "S"-Hooks are Double-Vinyl Coated to Prevent Scratches
- Use to Secure Cargo on Trucks and Trailers
- 333 lb. Working Load Limit
- 1000 lb. Maximum Breaking Strength

Item	Description	Packaging	Cs	In
6216	2-pc. 6' x 7/8" Cam Buckle Tie Downs	Sealed Blister	24	4
6217	4-pc. 6' x 7/8" Cam Buckle Tie Downs	Sealed Blister	12	4



15' x 1" Ratchet Tie Downs

- Weather-Resistant, Woven Polypropylene Strap
- Dual-Gear Ratchet Applies More Tension with Less Effort
- Quick-Release Dual Pawls Stay Locked and Maintain Tension During Transit
- Steel "S"-Hooks are Double-Vinyl Coated to Prevent Scratches
- Use to Secure Cargo on Trucks and Trailers
- 333 lb. Working Load Limit
- 1000 lb. Maximum Breaking Strength

Item	Description	Packaging	Cs	In
6221	15' x 1" Ratchet Tie Down	Slide Blister Card	24	6
6222	4-pc. 15' x 1" Ratchet Tie Downs	Sealed Blister	8	4



22' x 2" Ratchet Tie Down

- Weather-Resistant, Woven Polypropylene Strap
- Dual-Gear Ratchet Applies More Tension with Less Effort
- Quick-Release Dual Pawls Stay Locked and Maintain Tension During Transit
- Steel "S"-Hooks are Double-Vinyl Coated to Prevent Scratches
- Use to Secure Cargo on Trucks and Trailers
- 833 lb. Working Load Limit
- 2,500 lb. Maximum Breaking Strength

Item	Description	Packaging	Cs	In
6224	22' x 2" Ratchet Tie Down	Sealed Blister	16	4



5' Light Duty Cargo Strap

- Weather-Resistant, Woven Polypropylene Strap
- Rugged Nylon Quick-Release Buckle
- Use to Secure Luggage, Back Packs, and other Light Cargo
- 33 lb. Working Load Limit
- 100 lb. Maximum Breaking Strength

Item	Description	Packaging	Cs	In
6213	5' Light Duty Cargo Strap	Sealed Blister	72	6

EPDM Rubber Tie Downs

- Strong, Weather-Resistant Natural and Synthetic Rubber Blend
- Reinforced Molded Hook Inserts
- Galvanized Steel "S"-Hooks
- Multi-Purpose Tie Down for Tarps, Cars, Trucks, and Trailers

- MINIMUM ORDER QUANTITY: 10-PC. POLYBAG



Item	Description	Packaging	Cs	In
6190	10" EPDM Rubber Tie Down	Color Label	200	10
6195	15" EPDM Rubber Tie Down	Color Label	100	10
6200	21" EPDM Rubber Tie Down	Color Label	100	10
6205	31" EPDM Rubber Tie Down	Color Label	100	10
6210	41" EPDM Rubber Tie Down	Color Label	100	10

2-pc. Truck Bed Anchor Points

- Solid Steel Anchor
- Weather-Resistant Chrome Plated Finish
- Soft Rubber Gasket Prevents Damage to Vehicle Finish and Seals Tight to Keep Water Out
- Strong Anchor Points for Connecting Straps, Tie Downs, and Tarps to Secure and Cover Cargo
- Universal Design for Easy, Non-Permanent Installation in any Truck Bed with Stake Pockets

Specifications:

- Eye Diameter: 7/8"
- Base Plate: 2-1/2" L x 2-1/8" W
- Mounting Bolt: 3/8" x 2-1/2" L
- Toggle Wing: 2-7/8" W



Item	Description	Packaging	Cs	In
6228	2-pc. Truck Bed Anchor Points	Sealed Blister	24	6

Bungee Cords

- Elastic Design Provides Constant Tension
- Vinyl Coated Steel Hooks and Woven Polyester Strap Cover will not Mar Finish
- Color-Coded Sizes
- Use for Securing Loads on Cars, Trucks, Trailers, Bikes, Motorcycles, and RVs

- | | | |
|--------------------|--------------------|-------------------------|
| 6229 | 6230 | 6231 |
| • 4-pc. 8" Bungee | • 2-pc. 12" Bungee | • 4-pc. 10" Mini Bungee |
| • 2-pc. 18" Bungee | • 2-pc. 18" Bungee | |
| • 2-pc. 24" Bungee | • 2-pc. 24" Bungee | |
| • 2-pc. 30" Bungee | | |
| • 2-pc. 36" Bungee | | |

Item	Description	Packaging	Cs	In
6229	12-pc. Bungee Cord Set	Poly Bag/Hang Card	36	6
6230	6-pc. Bungee Cord Set	Poly Bag/Hang Card	72	12
6231	4-pc. 10" Mini Bungee Cord Set	Poly Bag/Hang Card	240	12



Heavy Duty Bungee Cords

- Heavy Duty 1/2" Diameter Elastic Strap Provides Constant Tension to Keep Cargo in Place
- Weather-Resistant Brass Plated Spring Steel Hooks and Woven Polyester Strap Cover
- Quickly Secures Tarps and Light Cargo on Trucks, Trailers, Vans, and SUVs

- MINIMUM ORDER QUANTITY: 10-PC. POLYBAG

Item	Description	Packaging	Cs	In
6246	18" Heavy Duty Bungee Cord	Color Label	100	10
6247	24" Heavy Duty Bungee Cord	Color Label	100	10
6248	32" Heavy Duty Bungee Cord	Color Label	100	10
6249	48" Heavy Duty Bungee Cord	Color Label	100	10
6250	64" Heavy Duty Bungee Cord	Color Label	100	10
6251	72" Heavy Duty Bungee Cord	Color Label	100	10



3-pc. Heavy Duty Bungee Cord Set

- Heavy Duty 1/2" Diameter Elastic Strap Provides Constant Tension to Keep Cargo in Place
- Weather-Resistant Chrome Plated Spring Steel Hooks and Woven Polyester Strap Cover
- Quickly Secures Tarps and Light Cargo on Trucks, Trailers, Vans, and SUVs

- 1-pc. 24" Bungee Strap (Blue)
- 1-pc. 36" Bungee Strap (Red)
- 1-pc. 48" Bungee Strap (White)

Item	Description	Packaging	Cs	In
6252	3-pc. Heavy Duty Bungee Cord Set	Poly Bag/Hang Card	40	5



STANDARD DUTY

BLUE

Item	Description	Packaging	Cs	In
6289	6' x 8' Blue Tarp	Poly Bag/Color Label	40	1
6294	8' x 10' Blue Tarp	Poly Bag/Color Label	25	1
6314	10' x 12' Blue Tarp	Poly Bag/Color Label	18	1
6324	10' x 20' Blue Tarp	Poly Bag/Color Label	10	1
6329	12' x 16' Blue Tarp	Poly Bag/Color Label	12	1
6349	16' x 20' Blue Tarp	Poly Bag/Color Label	8	1
6374	20' x 20' Blue Tarp	Poly Bag/Color Label	5	1

- Two-layer laminated polyethylene construction
- Water, rot, and mildew resistant
- Crack-resistant to -20° F
- UV Shield coating resists damaging ultraviolet rays for longer life



- 8 X 10 weave (per sq. in.)



- Braided poly rope reinforcing all around hem edge

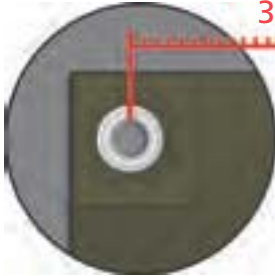

36"

- Rust-proof aluminum grommets at each corner and every 36" around hem



SILVER

Item	Description	Packaging	Cs	In
6270	4' x 6' Silver Tarp	Poly Bag/Color Label	60	1
6285	5' x 7' Silver Tarp	Poly Bag/Color Label	50	1
6290	6' x 8' Silver Tarp	Poly Bag/Color Label	40	1
6295	8' x 10' Silver Tarp	Poly Bag/Color Label	25	1
6300	9' x 12' Silver Tarp	Poly Bag/Color Label	20	1
6305	9' x 16' Silver Tarp	Poly Bag/Color Label	18	1
6310	10' x 10' Silver Tarp	Poly Bag/Color Label	20	1
6315	10' x 12' Silver Tarp	Poly Bag/Color Label	18	1
6320	10' x 15' Silver Tarp	Poly Bag/Color Label	16	1
6325	10' x 20' Silver Tarp	Poly Bag/Color Label	10	1
6328	12' x 12' Silver Tarp	Poly Bag/Color Label	16	1
6330	12' x 16' Silver Tarp	Poly Bag/Color Label	12	1
6335	12' x 20' Silver Tarp	Poly Bag/Color Label	10	1
6340	12' x 24' Silver Tarp	Poly Bag/Color Label	10	1
6342	14' x 18' Silver Tarp	Poly Bag/Color Label	10	1
6345	15' x 30' Silver Tarp	Poly Bag/Color Label	5	1
6350	16' x 20' Silver Tarp	Poly Bag/Color Label	8	1
6355	16' x 32' Silver Tarp	Poly Bag/Color Label	4	1
6360	18' x 24' Silver Tarp	Poly Bag/Color Label	5	1
6370	18' x 36' Silver Tarp	Poly Bag/Color Label	3	1
6375	20' x 20' Silver Tarp	Poly Bag/Color Label	5	1
6380	20' x 30' Silver Tarp	Poly Bag/Color Label	3	1
6385	20' x 40' Silver Tarp	Poly Bag/Color Label	2	1
6390	20' x 50' Silver Tarp	Poly Bag/Color Label	2	1
6392	24' x 24' Silver Tarp - Round	Poly Bag/Color Label	2	1
6395	26' x 40' Silver Tarp	Poly Bag/Color Label	2	1
6400	26' x 48' Silver Tarp	Poly Bag/Color Label	2	1
6405	29' x 29' Silver Tarp - Round	Poly Bag/Color Label	1	1
6406	30' x 30' Silver Tarp	Poly Bag/Color Label	2	1
6408	30' x 40' Silver Tarp	Poly Bag/Color Label	2	1
6410	30' x 50' Silver Tarp	Poly Bag/Color Label	1	1
6415	30' x 60' Silver Tarp	Poly Bag/Color Label	1	1
6420	33' x 33' Silver Tarp - Round	Poly Bag/Color Label	1	1
6425	40' x 60' Silver Tarp	Poly Bag/Color Label	1	1

GREEN

BROWN

Item	Description	Packaging	Cs	In
6280	4' x 18' Green/Brown Tarp	Poly Bag/Color Label	25	1
6286	6' x 8' Green/Brown Tarp	Poly Bag/Color Label	40	1
6291	6' x 24' Green/Brown Tarp	Poly Bag/Color Label	16	1
6296	8' x 10' Green/Brown Tarp	Poly Bag/Color Label	25	1
6301	9' x 12' Green/Brown Tarp	Poly Bag/Color Label	20	1
6316	10' x 12' Green/Brown Tarp	Poly Bag/Color Label	18	1
6326	10' x 20' Green/Brown Tarp	Poly Bag/Color Label	10	1
6331	12' x 16' Green/Brown Tarp	Poly Bag/Color Label	12	1
6351	16' x 20' Green/Brown Tarp	Poly Bag/Color Label	8	1
6376	20' x 20' Green/Brown Tarp	Poly Bag/Color Label	5	1
6381	20' x 30' Green/Brown Tarp	Poly Bag/Color Label	3	1
6386	20' x 40' Green/Brown Tarp	Poly Bag/Color Label	2	1

CAMOUFLAGE

Item	Description	Packaging	Cs	In
6438	4' x 18' Camouflage Tarp	Poly Bag/Color Label	25	1
6439	6' x 24' Camouflage Tarp	Poly Bag/Color Label	16	1
6440	6' x 8' Camouflage Tarp	Poly Bag/Color Label	40	1
6441	8' x 10' Camouflage Tarp	Poly Bag/Color Label	25	1
6442	9' x 12' Camouflage Tarp	Poly Bag/Color Label	20	1
6443	10' x 12' Camouflage Tarp	Poly Bag/Color Label	18	1
6444	10' x 20' Camouflage Tarp	Poly Bag/Color Label	10	1
6445	12' x 16' Camouflage Tarp	Poly Bag/Color Label	12	1
6446	16' x 20' Camouflage Tarp	Poly Bag/Color Label	8	1

DOUBLE DUTY

SILVER		BLACK	
--------	--	-------	--

Item	Description	Packaging	Cs	In
6292	6' x 8' Double Duty Tarp - Silver/Black	Poly Bag/Color Label	24	1
6297	8' x 10' Double Duty Tarp - Silver/Black	Poly Bag/Color Label	16	1
6312	10' x 10' Double Duty Tarp - Silver/Black	Poly Bag/Color Label	12	1
6317	10' x 12' Double Duty Tarp - Silver/Black	Poly Bag/Color Label	10	1
6323	10' x 20' Double Duty Tarp - Silver/Black	Poly Bag/Color Label	6	1
6332	12' x 16' Double Duty Tarp - Silver/Black	Poly Bag/Color Label	6	1
6337	12' x 20' Double Duty Tarp - Silver/Black	Poly Bag/Color Label	5	1
6338	12' x 24' Double Duty Tarp - Silver/Black	Poly Bag/Color Label	4	1
6347	15' x 30' Double Duty Tarp - Silver/Black	Poly Bag/Color Label	3	1
6352	16' x 20' Double Duty Tarp - Silver/Black	Poly Bag/Color Label	4	1
6362	18' x 24' Double Duty Tarp - Silver/Black	Poly Bag/Color Label	3	1
6377	20' x 20' Double Duty Tarp - Silver/Black	Poly Bag/Color Label	2	1
6382	20' x 30' Double Duty Tarp - Silver/Black	Poly Bag/Color Label	2	1
6387	20' x 40' Double Duty Tarp - Silver/Black	Poly Bag/Color Label	1	1
6402	30' x 40' Double Duty Tarp - Silver/Black	Poly Bag/Color Label	1	1
6412	30' x 50' Double Duty Tarp - Silver/Black	Poly Bag/Color Label	1	1
6427	40' x 60' Double Duty Tarp - Silver/Black	Poly Bag/Color Label	1	1



- Two-layer laminated polyethylene construction
- Water, rot, and mildew resistant
- Crack-resistant to -20° F
- UV Shield coating resists damaging ultraviolet rays for longer life



- 14 x 14 weave (per sq. in.)



- Braided poly rope reinforcing all around hem edge

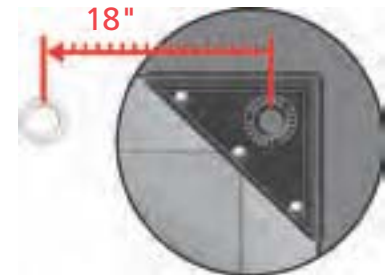

- Riveted poly anchor at each corner and rust-proof grommets every 18" around hem

53-pc. 1/2" Grommet Kit

- Standard Size 1/2" Weather-Resistant Brass Plated Grommets
- Heavy Duty Zinc Plated Steel Punches and Anvil
- Save Money by Repairing Tarps, Tents, Awnings, Pool Covers, Canopies, and More
- 1-pc. Anvil
- 1-pc. Hole Punch
- 1-pc. Grommet Crimper Punch
- 50-pc. 1/2" Grommets

Item	Description	Packaging	Cs	In
6430	53-pc. 1/2" Grommet Kit	Sealed Blister	50	10

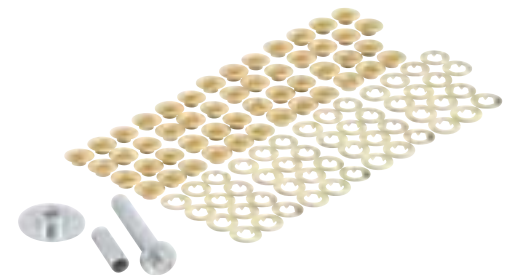

13-pc. 3/8" Grommet Kit

- Standard Size 3/8" Weather-Resistant Brass Plated Grommets
- One-Piece Steel Grommet Punch and Anvil Tool
- Save Money by Repairing Tarps, Tents, Awnings, Pool Covers, Canopies, and More
- 12-pc. 3/8" Grommets
- 1-pc. Grommet Tool

Item	Description	Packaging	Cs	In
6590	13-pc. 3/8" Grommet Kit	Slide Blister Card	72	12



50-pc. 3/8" Brass Grommets

- Standard Size 3/8" Weather-Resistant Brass Plated Grommets
- Save Money by Repairing Tarps, Tents, Awnings, Pool Covers, Canopies, and More
- 50-pc. 3/8" Grommets

Item	Description	Packaging	Cs	In
6595	50-pc. 3/8" Brass Grommets	Slide Blister Card	72	12

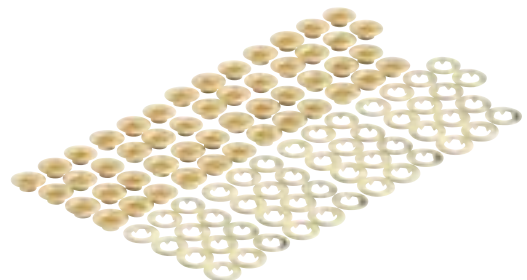



3/8" Drive Butterfly Impact Wrench

- Die Cast Aluminum Body
- Compact Housing for Access to Tight Areas
- Forward/Reverse Variable Speed Butterfly Throttle
- Rubber Anti-Scuff Nose Guard
- Built-in Air Regulator
- Maximum Torque: 75 Ft./Lb.
- Maximum Speed: 10,000 RPM
- Working Air Pressure: 90 PSI
- Average Air Consumption: 2.5 CFM
- Air Inlet: 1/4"
- Minimum Air Hose Size: 3/8"
- 1-pc. Butterfly Impact Wrench
- 2-pc. Replacement Gaskets
- 4-pc. Replacement Valve Seat Seals

Item	Description	Packaging	Cs	In
4095	3/8" Drive Butterfly Impact Wrench	Sealed Blister	20	5



3/8" Drive Impact Wrench

- Die Cast Aluminum Body
- Variable Speed Reversible Drive
- Comfortable Pistol Grip Handle with Oversized Trigger
- Ball Bearing Motor
- Built-in Air Regulator
- Maximum Torque: 130 Ft./Lb.
- Maximum Speed: 12,000 RPM
- Working Air Pressure: 90 PSI
- Average Air Consumption: 3 CFM
- Air Inlet: 1/4"
- Minimum Air Hose Size: 3/8"
- 1-pc. Impact Wrench
- 1-pc. Hex Wrench

Item	Description	Packaging	Cs	In
4100	3/8" Drive Impact Wrench	Sealed Blister	10	5



1/2" Drive Impact Wrench

- Die Cast Aluminum Body
- Variable Speed Reversible Drive
- Non-Slip Cushioned Pistol Grip Handle with Oversized Trigger
- Ball Bearing Motor
- Maximum Torque: 260 Ft./Lb.
- Maximum Speed: 6,500 RPM
- Working Air Pressure: 90 PSI
- Average Air Consumption: 4 CFM
- Air Inlet: 1/4"
- Minimum Air Hose Size: 3/8"
- 1-pc. Impact Wrench
- 1-pc. Hex Wrench

Item	Description	Packaging	Cs	In
4105	1/2" Drive Impact Wrench	Sealed Blister	10	5



1/2" Drive Impact Wrench

- Heavy Duty Die Cast Aluminum Body
- Twin-Hammer Design Delivers up to 400 Ft./Lb. of Torque
- Variable Speed Reversible Drive
- Non-Slip Cushioned Pistol Grip Handle with Oversized Trigger
- Ball Bearing Motor
- Maximum Torque: 400 Ft./Lb.
- Maximum Speed: 7,000 RPM
- Working Air Pressure: 90 PSI
- Average Air Consumption: 4 CFM
- Air Inlet: 1/4"
- Minimum Air Hose Size: 3/8"
- 1-pc. Impact Wrench
- 1-pc. Hex Wrench

Item	Description	Packaging	Cs	In
4108	1/2" Drive Impact Wrench	Sealed Blister	10	5

1/4" Drive Air Ratchet

- Forged Steel Head and Aluminum Body
- Variable Speed Reversible Drive
- Lever-Style Throttle
- Ball Bearing Motor
- Compact Head Reaches into Tight Areas
- Maximum Torque: 25 Ft./Lb.
- Maximum Speed: 250 RPM
- Working Air Pressure: 90 PSI
- Average Air Consumption: 4 CFM
- Air Inlet: 1/4"
- Minimum Air Hose Size: 3/8"

Item	Description	Packaging	Cs	In
4150	1/4" Drive Air Ratchet	Sealed Blister	20	5



3/8" Drive Air Ratchet

- Forged Steel Head and Aluminum Body
- Variable Speed Reversible Drive
- Lever-Style Throttle
- Non-Slip Cushion Grip Housing
- Ball Bearing Motor
- Compact Head Reaches into Tight Areas
- Maximum Torque: 50 Ft./Lb.
- Maximum Speed: 160 RPM
- Working Air Pressure: 90 PSI
- Average Air Consumption: 4 CFM
- Air Inlet: 1/4"
- Minimum Air Hose Size: 3/8"

Item	Description	Packaging	Cs	In
4155	3/8" Drive Air Ratchet	Sealed Blister	20	5



1/2" Drive Air Ratchet

- Forged Steel Head and Aluminum Body
- Variable Speed Reversible Drive
- Lever-Style Throttle
- Non-Slip Cushion Grip Housing
- Ball Bearing Motor
- Compact Head Reaches into Tight Areas
- Maximum Torque: 50 Ft./Lb.
- Maximum Speed: 160 RPM
- Working Air Pressure: 90 PSI
- Average Air Consumption: 4 CFM
- Air Inlet: 1/4"
- Minimum Air Hose Size: 3/8"

Item	Description	Packaging	Cs	In
4160	1/2" Drive Air Ratchet	Sealed Blister	20	5





7-pc. 150mm Air Hammer Set

- Die Cast Aluminum Body
- Variable Speed Drive
- Non-Slip Cushion Grip Handle
- Spring-Type Tool Retainer
- Chrome Molybdenum Steel Chisels

- Blows per Minute: 4500
- Bore: 3/4"
- Stroke: 1-5/8"
- Chisel Shank: .401"
- Working Air Pressure: 90 PSI
- Average Air Consumption: 4 CFM
- Air Inlet: 1/4"
- Minimum Air Hose Size: 3/8"

- 1-pc. Air Hammer
- 1-pc. Tool Retaining Spring
- 1-pc. Male Quick Connector
- 4-pc. 5" Chisels: Flat Chisel, Weld Breaker, Cutting Chisel, and Tapered Punch

Item	Description	Packaging	Cs	In
4185	7-pc. 150mm Air Hammer Set	Sealed Blister	10	5



7-pc. 190mm Air Hammer Set

- Die Cast Aluminum Body
- Variable Speed Drive
- Non-Slip Cushion Grip Handle
- Spring-Type Tool Retainer
- Chrome Molybdenum Steel Chisels

- Blows per Minute: 3500
- Bore: 11/16"
- Stroke: 2-5/8"
- Chisel Shank: .401"
- Working Air Pressure: 90 PSI
- Average Air Consumption: 4 CFM
- Air Inlet: 1/4"
- Minimum Air Hose Size: 3/8"

- 1-pc. Air Hammer
- 1-pc. Tool Retaining Spring
- 1-pc. Male Quick Connector
- 4-pc. 5" Chisels: Flat Chisel, Weld Breaker, Cutting Chisel, and Tapered Punch

Item	Description	Packaging	Cs	In
4190	7-pc. 190mm Air Hammer Set	Sealed Blister	10	5



9-pc. Air Chisel Set

- Hardened Chrome Molybdenum Steel
- Precision Machined Tips
- Universal Fit .401" Shank
- Complete with Organizer Storage Pouch

- 4-pc. 5" Chisels: Flat Chisel, Weld Breaker, Cutting Chisel, and Tapered Punch
- 5-pc. 7" Chisels: Rivet Cutter, "V" Cutting Chisel, Half Round Cutting Chisel, Sheet Metal Cutter, Slot Panel Cutter

Item	Description	Packaging	Cs	In
4215	9-pc. Air Chisel Set	Sealed Blister	18	3



3/8" Reversible Air Drill

- Lightweight Aluminum Body
- Rugged Nickel Chrome Molybdenum Gears
- Variable Speed Trigger
- Reversible Drive
- Industrial-Grade 3/8" Jacobs® Keyed Chuck
- Handle Outlet Directs Exhaust Away from Work Area
- Non-Slip Rubberized Grip Improves Control and Reduces Fatigue

- Working Speed: 1650 RPM
- Maximum Free Speed: 1800 RPM
- Working Air Pressure: 90 PSI
- Average Air Consumption: 4 CFM
- Air Inlet: 1/4" NPT
- Minimum Air Hose Size: 3/8" I.D.
- 1-pc. 3/8" Air Drill
- 1-pc. Chuck Key

Item	Description	Packaging	Cs	In
4421	3/8" Reversible Air Drill	Sealed Blister	10	5



1/4" Die Grinder

- Die Cast Aluminum Body
- Rear Exhaust Directs Air Away from Work Piece
- Variable Speed
- Lever-Style Throttle with Lock-Out Safety Switch
- Non-Slip Cushion Grip Housing
- Ball Bearing Motor
- Compact Size for Easy Handling in Tight Spots

- Collet Size: 1/4"
- Maximum Speed: 22,000 RPM
- Working Air Pressure: 90 PSI
- Average Air Consumption: 3.5 CFM
- Air Inlet: 1/4"
- Minimum Air Hose Size: 3/8"

- 1-pc. Die Grinder
- 2-pc. Chuck Wrenches

Item	Description	Packaging	Cs	In
4255	1/4" Die Grinder	Sealed Blister	25	5



1/4" Angle Die Grinder

- Die Cast Aluminum Body
- 90° Angled Head Reaches Work in Tight Areas
- Variable Speed
- Lever-Style Throttle with Lock-Out Safety Switch
- Non-Slip Cushion Grip Housing
- Nickel Chrome Molybdenum Gears for Long Service Life

- Collet Size: 1/4"
- Maximum Speed: 20,000 RPM
- Working Air Pressure: 60 PSI
- Average Air Consumption: 6 CFM
- Air Inlet: 1/4"
- Minimum Air Hose Size: 3/8"

- 1-pc. Die Grinder
- 2-pc. Chuck Wrenches

Item	Description	Packaging	Cs	In
4260	1/4" Angle Die Grinder	Sealed Blister	30	5



3" Utility Cut-Off Tool

- Die Cast Aluminum Body
- Rear Exhaust Directs Air Away from Work Piece
- Variable Speed
- Lever-Style Throttle with Lock-Out Safety Switch
- Non-Slip Cushion Grip Housing
- Ball Bearing Motor
- 180-degree Safety Guard

- Maximum Speed: 22,000 RPM
- Working Air Pressure: 90 PSI
- Average Air Consumption: 4 CFM
- Air Inlet: 1/4"
- Minimum Air Hose Size: 3/8"

- 1-pc. Utility Cut-Off Tool
- 1-pc. 3" Cut-Off Wheel
- 1-pc. Hex Key Wrench
- 1-pc. Chuck Wrench

Item	Description	Packaging	Cs	In
4315	3" Utility Cut-Off Tool	Sealed Blister	20	5



3" x 1/16" Cut-Off Wheels

- Reinforced, Bonded Carbon Construction
- Cuts Steel Rods and Bolts, Sheet Metal, and Muffler Clamps
- Universal Fit for Most Pneumatic Cut-Off Tools
- Diameter: 3"
- Arbor: 3/8"
- Thickness: 1/16"
- Maximum Speed: 20,000 RPM

Item	Description	Packaging	Cs	In
4320	3" x 1/16" Cut-Off Wheel	Bulk/UPC	1000	50
4325	5-pc. 3" Utility Cut-Off Wheels	Blister Card	144	12



5" High Speed Sander

- Lightweight Die Cast Aluminum Body
- Variable Speed Trigger
- Ball Bearing Motor
- Non-Slip Cushioned Handle Grip
- Maximum Speed: 18,000 RPM
- Working Air Pressure: 80 PSI
- Average Air Consumption: 5.2 CFM
- Air Inlet: 1/4"
- Minimum Air Hose Size: 3/8"
- 1-pc. High Speed Sander
- 3-pc. Sanding Pads: 3", 4-1/2", 5"
- 1-pc. Retaining Screw
- 1-pc. Cross Bar Wrench

Item	Description	Packaging	Cs	In
4275	5" High Speed Sander	Sealed Blister	10	5



Dual Piston Straight Line Sander

- Die Cast Aluminum Body
- Variable Speed
- Comfortable Contoured Handles
- Ball Bearing Motor with Dual Drive Pistons
- Sand Paper Size: 2-3/4" x 17-1/2"
- Stroke Length: 1"
- Strokes per Minute: 3000 RPM
- Working Air Pressure: 60 PSI
- Average Air Consumption: 6 CFM
- Air Inlet: 1/4"
- Minimum Air Hose Size: 3/8"

Item	Description	Packaging	Cs	In
4305	Dual Piston Straight Line Sander	Color Box	6	1



6" Dual Action Sander

- Die Cast Aluminum Body
- Balanced Ball-Bearing Construction for Quiet, Low-Vibration Operation
- Variable Speed
- Lever-Style Throttle
- Non-Slip Cushion Handle Grip
- Muffler for Quiet Operation
- 1-pc. Dual Action Sander
- 1-pc. 6" Neoprene Sanding Pad
- Spindle Thread Size: 5/16" (24 UNF)
- Maximum Speed: 10,000 RPM
- Working Air Pressure: 90 PSI
- Average Air Consumption: 4 CFM
- Air Inlet: 1/4"
- Minimum Air Hose Size: 3/8"

Item	Description	Packaging	Cs	In
4285	6" Dual Action Sander	Sealed Blister	10	5



6" Dual Action Sanding Pad

- Firm, Flexible Neoprene Construction
- 6" Diameter Uses Standard Self-Adhesive Sanding Discs
- Maximum Speed: 10,000 RPM
- 5/16" (24 UNF) Spindle Thread
- Fits Most Dual Action Air Sanders

Item	Description	Packaging	Cs	In
4295	6" Dual Action Sanding Pad	Poly Bag/Hang Card	100	10

Paint Spray Gun

- Professional-Grade Dual Action, External Mix, Siphon Feed Spray Gun
- Brass Head with Adjustable Spray Pattern Control
- Precision-Machined Brass Nozzle Provides a Constant, Uniform Finish
- Comfortable Oversized Trigger Reduces Fatigue
- Anti-Drip One-Liter Aluminum Quick Release Paint Cup

- Nozzle Diameter: 1.8 mm
- Air Inlet: 1/4"
- Fluid Inlet: 3/8"
- Cup Capacity: 1 Liter
- Minimum Compressor: 1-1/2 HP
- Working Air Pressure: 50-70 PSI
- Average Air Consumption: 8.5-12 CFM

Item	Description	Packaging	Cs	In
4360	Paint Spray Gun	Color Box	10	1



Paint Spray Gun

- Professional-Grade Dual Action, External Mix, Siphon Feed Spray Gun
- Brass Head with Adjustable Spray Pattern Control
- Precision-Machined Brass Nozzle Provides a Constant, Uniform Finish
- Comfortable Oversized Trigger Reduces Fatigue
- Anti-Drip One-Liter Aluminum Quick Release Paint Cup

- Nozzle Diameter: 1.8 mm
- Air Inlet: 1/4"
- Fluid Inlet: 3/8"
- Cup Capacity: 1 Liter
- Minimum Compressor: 1-1/2 HP
- Working Air Pressure: 50-70 PSI
- Average Air Consumption: 8.5-12 CFM

Item	Description	Packaging	Cs	In
4365	Paint Spray Gun	Color Box	10	1



Touch-Up Spray Gun

- Lightweight, Compact Size Designed for Stenciling, Touch-up, and Precise Detail Spraying
- Rugged Cast Aluminum Head
- Precision-Machined External Mix Brass Nozzle
- Fully Adjustable Spray Pattern
- Comfortable Oversized Trigger Reduces Fatigue
- Anti-Drip 1/4 Liter Quick-Release Aluminum Paint Cup

- Nozzle Diameter: 1.5 mm
- Fluid Inlet: 3/8"
- Cup Capacity: .25 Liter
- Working Air Pressure: 30-50 PSI
- Average Air Consumption: 4 CFM
- Air Inlet: 1/4"

Item	Description	Packaging	Cs	In
4375	Touch-Up Spray Gun	Color Box	20	1





Engine Cleaning Gun

- All-Purpose Spray Cleaning Gun Degreases Engine Compartments and Machinery, Removes Road Grime from Wheels and Tires, Cleans Hard-to-Reach Areas, and Much More
- High-Pressure Nozzle Delivers Heavy Duty Cleaning Power
- Extra Long 9" Wand Reaches into Tight Spaces
- Variable-Pressure Trigger Controls Spray Volume
- Adjustable Siphon Feed Control
- Sprays Engine Cleaners, Degreasers, Detergents, and Solvents for Maximum Cleaning Power
- 4' Siphon Hose with Built-in Filter Screen

Specifications:

- Air Inlet: 1/4" NPT
- Working Air Pressure: 90 PSI
- Average Air Consumption: 5 CFM
- Minimum Air Compressor: 1 HP (delivering constant 5 CFM)

- 1-pc. High-Pressure Spray Gun
- 1-pc. 4-ft. Siphon Hose

Item	Description	Packaging	Cs	In
4510	Engine Cleaning Gun	Slide Blister Card	24	6



Air Sandblasting Kits

- Compact, Lightweight, Siphon-Type Sandblaster
- Multi-Purpose Design Can Use Abrasives, Liquid or Air to Clean Parts and Surfaces
- Operates with Most Common Abrasives Including Aluminum Oxide, Silicon Carbide, Bead, and Steel Grit
- Aspirator System Assures Uninterrupted Flow of Blasting Material
- Lightweight Cast Aluminum Blasting Gun is Fully Contoured for a Comfortable Grip
- Flexible 10' Rubber Hose and Durable Plated Steel Pickup Tube

Specifications:

- Working Air Pressure: 60-120 PSI
- Maximum Air Pressure: 150 PSI
- Average Air Consumption: 6 CFM
- Air Inlet: 1/4"

- 1-pc. Blasting Gun
- 1-pc. Pickup Tube
- 1-pc. 10' Siphon Hose
- 4-pc. Sandblasting Nozzles: .230" I.D. Steel (2), .275" I.D. Steel, .215" I.D. Ceramic
- 1-pc. Replacement Air Jet
- 1-pc. Hex Key Wrench

4530

- Quick and Easy Installation
- Universal Replacement Tips for Siphon-Type Air Sandblasters
- Fits TEKTON® #4520 Air Sandblaster
- 3-pc. 1/4" Nozzles
- 1-pc. 5/64" Air Jet
- 1-pc. 1/8" Hex Key Wrench

Item	Description	Packaging	Cs	In
4520	Air Sandblasting Kit	Slide Blister Card	10	1
4530	5-pc. Air Sandblasting Tip Kit	Slide Blister Card	144	12



17-pc. Air Tool Accessory Kit

- Complete Assortment of Clean-up and Inflation Tools, Adapters, and Air Tool Connectors
- Universal Fit 1/4" NPT

- 1-pc. Blow Gun
- 1-pc. 50 PSI Tire Gauge
- 1-pc. Dual Tire Chuck
- 1-pc. Precision Nozzle
- 1-pc. Safety Nozzle/Tip Adapter
- 1-pc. Power Wire Brush
- 2-pc. Female Quick Connect Plugs
- 2-pc. Male Quick Connect Plugs
- 2-pc. Quick Connect Couplers
- 2-pc. Male Couplers
- 1-pc. Female Coupler
- 2-pc. Inflation Needles

Item	Description	Packaging	Cs	In
47261	17-pc. Air Tool Accessory Kit	Sealed Blister	24	4



Air Blow Gun

- Rugged Cast Zinc Body with Hanging Storage Hook
- Corrosion-Resistant Chrome Plated Finish
- Comfortable Non-Slip Control Lever
- Clears Dust and Debris from Work Area
- Includes Vented Safety Nozzle to Prevent Pressure Build-Up if Nozzle Becomes Obstructed
- Air Inlet: 1/4" NPT

- 1-pc. Blow Gun
- 1-pc. High Pressure Nozzle
- 1-pc. Vented Safety Nozzle

Item	Description	Packaging	Cs	In
4740	Air Blow Gun	Slide Blister Card	72	12



1/4" NPT Quick Connect Plugs (M-Style)

- Rugged Solid Brass Construction
- Precision Machined for Leak-Proof Operation
- Allows One-Touch Connecting and Disconnecting of Tools and Accessories
- 1/4" NPT Industrial Interchange (M-Style) Plug
- Fits M-Style or Universal Quick Coupler

Item	Description	Packaging	Cs	In
4711	1/4" NPT Quick Connect Male Plug (M-Style)	Slide Blister Card	288	12
4712	1/4" NPT Quick Connect Female Plug (M-Style)	Slide Blister Card	288	12

1/4" NPT Quick Connect Couplers (M-Style)

- Rugged Solid Brass Construction
- Precision Machined for Leak-Proof Operation
- Allows One-Touch Connecting and Disconnecting of Tools and Accessories
- 1/4" NPT Industrial Interchange (M-Style) Coupler
- Fits M-Style or Industrial Interchange Quick Connect Plugs

Item	Description	Packaging	Cs	In
4713	1/4" NPT Quick Connect Male Coupler (M-Style)	Slide Blister Card	144	12
4714	1/4" NPT Quick Connect Female Coupler (M-Style)	Slide Blister Card	144	12

5-pc. Quick Coupler Sets

- Rugged Solid Brass Construction
- Precision Machined for Leak-Proof Operation
- Allows One-Touch Connecting and Disconnecting of Tools and Accessories
- Fittings Rotate to Eliminate Twisted Hoses
- Universal Fit for 1/4" NPT Tools

4720	4725
• 1-pc. Female Quick Coupler	• 1-pc. Female Quick Coupler
• 1-pc. Female Connector	• 1-pc. Female Connector
• 3-pc. Male Connectors	• 2-pc. Male Connectors
	• 1-pc. Nipple



Item	Description	Packaging	Cs	In
4720	5-pc. Quick Coupler Set	Slide Blister Card	72	12
4725	5-pc. Quick Coupler Set	Slide Blister Card	72	12



Brass Universal Quick Coupler

- Rugged Solid Brass Construction
- Precision Machined for Leak-Proof Operation
- Allows One-Touch Connecting and Disconnecting of Tools and Accessories
- Universal Design Fits any Style 1/4" NPT Quick Connect Male Plug
- Air Inlet: 1/4" NPT

Item	Description	Packaging	Cs	In
4727	Brass Universal Quick Coupler	Slide Blister Card	144	12



Female Coupler

- Solid Brass Construction
- Precision-Machined for Leak-Proof Operation
- 1/4" NPT (F) x 1/4" NPT (F)

Item	Description	Packaging	Cs	In
4728	Female Coupler	Slide Blister Card	288	12



3-Way Air Hose Splitter Manifold (1/4" NPT)

- Splits One Air Source to Supply Three Air Hose Lines
- Solid Brass Construction
- 1/4" NPT (F) Inlet
- 1/4" NPT (F) Outlets

Item	Description	Packaging	Cs	In
4730	3-Way Air Hose Splitter Manifold (1/4" NPT)	Slide Blister Card	100	10



7-pc. 1/4" NPT Air Hose Repair Kit

- Save Money - Repair Damaged Hoses Yourself Quickly and Easily
- Repairs Rubber and PVC Hoses
- Precision-Machined Solid Brass Pieces Fit Tightly to Prevent Leaks
- 7/8" Long, Deep-Toothed Barbs Grip Securely to Prevent Pulling Free Under Strain
- 1-pc. 1/4" NPT Hose Splicer
- 1-pc. 1/4" NPT Male End Fitting
- 1-pc. 1/4" NPT Swivel Female End Fitting
- 4-pc. Hose Clamps

Item	Description	Packaging	Cs	In
4732	7-pc. 1/4" NPT Air Hose Repair Kit	Slide Blister Card	96	12



In-Line Oiler

- Provides Constant and Consistent Lubrication to Extend Tool Life and Maximize Performance
- Solid Brass Construction for Leak-Free Operation
- Transparent Reservoir for Easy Monitoring of Oil Level
- Toolless Thumb Screw Filler Cap

- Max. Air Pressure: 120 PSI
- Air Inlet: 1/4" NPT
- Air Outlet: 1/4" NPT

Item	Description	Packaging	Cs	In
4733	In-Line Oiler	Slide Blister Card	100	50



1/4" NPT Universal Swivel Connector

- Universal Dual-Swivel Design Increases Flexibility at Tool / Hose Connection
- Eliminates Twisted and Kinked Hoses
- Precision-Machined Zinc Alloy Body and Solid Brass Swivel Fitting
- 1/4" NPT (M) x 1/4" NPT (F)
- Max. Working Pressure: 100 PSI

Item	Description	Packaging	Cs	In
4731	1/4" NPT Universal Swivel Connector	Slide Blister Card	144	12



1/2" NPT (F) x 1/4" NPT (M) Reducer

- Solid brass construction
- Precision-machined for leak-free operation
- 1/2" NPT (F) x 1/4" NPT (M)

Item	Description	Packaging	Cs	In
4734	1/2" NPT (F) x 1/4" NPT (M) Reducer	Slide Blister Card	288	12



Oil/Water Separator

- Eliminates Water Buildup in Air Line
- Traps Water Vapor to Maximize Air Tool Performance and Extend Tool Life

Specifications:

- Max. Air Pressure: 150 PSI
- Air Inlet: 1/4" NPT
- Air Outlet: 1/4" NPT

Item	Description	Packaging	Cs	In
4755	Oil/Water Separator	Blister Card	72	12



4570



4575



Brass Air Regulators

4570

- Solid Brass Construction
- Thumbscrew Valve Control
- Controls Air Flow to Fine-Tune Performance of Sanders, Spray Guns, and other Tools
- 1/4" NPT Inlet x 1/4" NPT Outlet

4575

- Solid Brass Construction
- Thumbscrew Valve Control
- 160 PSI Air Pressure Gauge
- Controls Air Flow to Fine-Tune Performance of Sanders, Spray Guns, and other Tools
- 1/4" NPT Inlet x 1/4" NPT Outlet

Item	Description	Packaging	Cs	In
4570	Brass Air Regulator	Slide Blister Card	200	10
4575	Air Regulator with Gauge	Slide Blister Card	100	10

In-Line Air Regulator with Gauge

- High-Contrast, Easy-Read Dial Gauge
- Oversized Locking Air Pressure Adjustment Knob
- Controls Air Pressure Providing Smooth and Consistent Tool Performance
- Protects Hoses, Tools, and Accessories from Damage

Specifications:

- Maximum Air Pressure: 150 PSI
- Air Inlet: 3/8" NPT
- Air Outlet: 3/8" NPT
- Not Recommended for Air Compressors Over 5 HP

Item	Description	Packaging	Cs	In
4582	In-Line Air Regulator with Gauge	Sealed Blister	12	6

In-Line Air Filter

- Traps and Removes Harmful Water Vapor and Debris Particles from Compressed Air Supply
- Metal Outer Shield Protects Internal Filter Unit
- Easy-Clean Filter with Brass Drain Valve
- Delivers Clean Air Supply to Maximize Tool Performance
- Protects Hoses, Tools, and Accessories from Excessive Wear and Damage

Specifications:

- Maximum Air Pressure: 150 PSI
- Air Inlet: 3/8" NPT
- Air Outlet: 3/8" NPT
- Not Recommended for Air Compressors Over 5 HP

Item	Description	Packaging	Cs	In
4583	In-Line Air Filter	Sealed Blister	12	6



Air Filter/Regulator/Lubricator Unit

- Complete Air Management System Includes Filter, Regulator, and Lubricator
- Filter Traps and Removes Harmful Water Vapor and Debris Particles from Compressed Air Supply
- Easy-Clean Filter Canister with Brass Drain Valve
- Regulator Features High-Contrast Dial Face and Oversized Adjustment Knob
- Micro-Fog Lubricator Creates a Light Oil Mist to Properly and Consistently Lubricate Moving Air Tool Parts
- Delivers Clean, Lubricated Air Supply to Maximize Performance and Extend Tool Life
- Protects Hoses, Tools, and Accessories from Excessive Wear and Damage

- Maximum Air Pressure: 150 PSI
- Operating Temperature: 5 - 60° C
- Lubricator:
 - Air Inlet/Outlet: 3/8" NPT
 - Working Air Flow Rate: 85 CFM
 - Bowl Capacity: 4 oz.
 - Recommended Lubricant: ISO-VG 32 grade oil
- Regulator:
 - Air Inlet/Outlet: 3/8" NPT
 - Working Air Flow Rate: 90 CFM
- Filter:
 - Air Inlet/Outlet: 3/8" NPT
 - Working Air Flow Rate: 90 CFM
 - Bowl Capacity: 4 oz.
- Not Recommended for Air Compressors Over 5 HP

Item	Description	Packaging	Cs	In
4592	Air Filter/Regulator/Lubricator Unit	Sealed Blister	5	1



Retractable Air Hose Reels

- Heavy Duty Industrial Grade Rubber Air Hose
- Heavy Gauge All Steel Reel Assembly
- 8-Position Ratchet Gearing Locks Reel at Desired Hose Length
- Features Auto Rewind, Spring-Powered Automatic Recoil
- Mount Reel on Ceiling, Wall, or Floor - Wherever it is Most Convenient

Item #	Hose Size	Air Inlet to Reel	Hose End Fittings	Max. Capacity	Max. Air Flow
4677	3/8" x 25'	1/4" NPT (F)	1/4" NPT (M)	300PSI	25 CFM
4678	3/8" x 50'	1/4" NPT (F)	1/4" NPT (M)	300PSI	25 CFM
4679	1/2" x 50'	1/2" NPT (F)	1/2" NPT (M)	300PSI	35 CFM

Item	Description	Packaging	Cs	In
4677	25' x 3/8" Retractable Air Hose Reel	Color Box	1	1
4678	50' x 3/8" Retractable Air Hose Reel	Color Box	1	1
4679	50' x 1/2" Retractable Air Hose Reel	Color Box	1	1

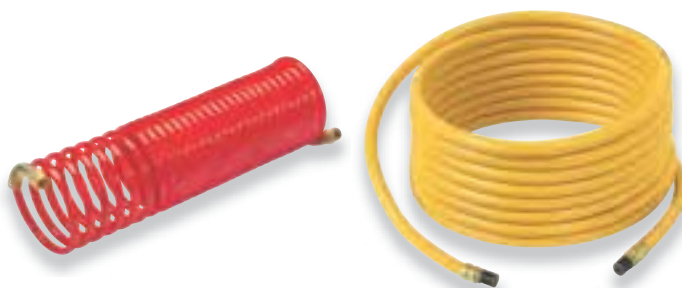
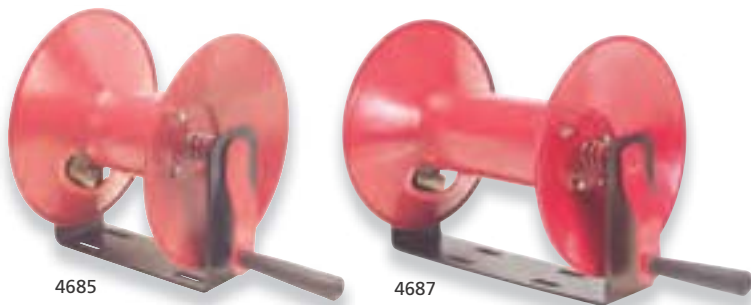

50' and 100' Manual Hose Reels

- 50' Air Hose Capacity (hose not included)
- 1/4" NPT Air Inlet, 300 PSI Max. Working Pressure
- Precision-Machined Brass Air Inlet Fitting for Leak-Free Operation
- Heavy-Gauge, All-Steel Construction
- One-Piece "U" Mounting Bracket
- Spring Tension Axle Brake Stops and Holds Reel at Desired Position
- Comfortable Swivel Crank Handle
- Corrosion-Resistant Powder Coat Finish
- Mount on Floor, Wall, or Workbench

4687

- 100' Air Hose Capacity (hose not included)

Item	Description	Packaging	Cs	In
4685	Hand Crank Air Hose Reel (50' Capacity)	Color Box	1	1
4687	Hand Crank Air Hose Reel (100' Capacity)	Color Box	1	1

Air Hoses

4625

- Self-Storing Design Springs Back into Coiled Shape After Each Use
- Rugged Oil- and Abrasion-Resistant Nylon Construction
- Leak-Resistant, 360° Swivel Brass End Connectors

- Spring Bend Restrictors Prevent Kinks Near Hose End

- Hose Size: 1/4" I.D. x 25'
- Connector Size: 1/4" NPT
- Working Pressure: 200 PSI

4647 / 4648

- Abrasion, Kink, and Weather-Resistant PVC Construction
- Solid Brass End Fittings: 1/4" NPT
- 200 PSI Working Pressure
- 600 PSI Burst Pressure

Item	Description	Packaging	Cs	In
4625	25' x 1/4" Recoil Air Hose	Color Label	40	10
4647	3/8" x 25' PVC Air Hose	Color Label	10	1
4648	3/8" x 50' PVC Air Hose	Color Label	5	1

25' x 1/2" Thread Sealing Tape (2 Rolls)

- Seals Tapered Threaded Metal and Plastic Pipe Connections
- PTFE Tape Reduces Friction and Plugs Gaps Between Threads to Create a Leak-Free Seal
- Suitable for Water and Air Connections

Item	Description	Packaging	Cs	In
7400	25' x 1/2" Thread Sealing Tape (2 Rolls)	Slide Blister Card	300	10



Individual Impact Sockets 157

- Drop Forged Heat Treated Chrome Vanadium Steel
- Corrosion-Resistant Black Oxide or Phosphate Finish
- Hole on Socket Locks on to Drive Tang
- Meets or Exceeds ANSI Specifications

- 4934 / 4935 / 4936 / 4938 / 4943
- Drop Forged, Heat Treated Chrome Molybdenum Steel

- OPTI-DRIVE™ DESIGN:
- Eliminates Corner Contact to Prevent Fastener from Rounding Off

Item	Description	Packaging	Cs	In
47750	1/2" Drive x 7/16" Shallow Impact Socket	Plastic Hang Tab/Label	144	6
47751	1/2" Drive x 1/2" Shallow Impact Socket	Plastic Hang Tab/Label	144	6
47752	1/2" Drive x 9/16" Shallow Impact Socket	Plastic Hang Tab/Label	144	6
47753	1/2" Drive x 5/8" Shallow Impact Socket	Plastic Hang Tab/Label	144	6
47754	1/2" Drive x 11/16" Shallow Impact Socket	Plastic Hang Tab/Label	144	6
47755	1/2" Drive x 3/4" Shallow Impact Socket	Plastic Hang Tab/Label	144	6
47756	1/2" Drive x 13/16" Shallow Impact Socket	Plastic Hang Tab/Label	144	6
47757	1/2" Drive x 7/8" Shallow Impact Socket	Plastic Hang Tab/Label	144	6
47758	1/2" Drive x 15/16" Shallow Impact Socket	Plastic Hang Tab/Label	144	6
47759	1/2" Drive x 1" Shallow Impact Socket	Plastic Hang Tab/Label	144	6
47760	1/2" Drive x 1-1/16" Shallow Impact Socket	Plastic Hang Tab/Label	144	6
47761	1/2" Drive x 1-1/8" Shallow Impact Socket	Plastic Hang Tab/Label	72	6
47762	1/2" Drive x 1-1/4" Shallow Impact Socket	Plastic Hang Tab/Label	72	6
47765	1/2" Drive x 10mm Shallow Impact Socket	Plastic Hang Tab/Label	144	6
47766	1/2" Drive x 11mm Shallow Impact Socket	Plastic Hang Tab/Label	144	6
47767	1/2" Drive x 12mm Shallow Impact Socket	Plastic Hang Tab/Label	144	6
47768	1/2" Drive x 13mm Shallow Impact Socket	Plastic Hang Tab/Label	144	6
47769	1/2" Drive x 14mm Shallow Impact Socket	Plastic Hang Tab/Label	144	6
47770	1/2" Drive x 15mm Shallow Impact Socket	Plastic Hang Tab/Label	144	6
47771	1/2" Drive x 16mm Shallow Impact Socket	Plastic Hang Tab/Label	144	6
47772	1/2" Drive x 17mm Shallow Impact Socket	Plastic Hang Tab/Label	144	6
47773	1/2" Drive x 18mm Shallow Impact Socket	Plastic Hang Tab/Label	144	6
47774	1/2" Drive x 19mm Shallow Impact Socket	Plastic Hang Tab/Label	144	6
47776	1/2" Drive x 21mm Shallow Impact Socket	Plastic Hang Tab/Label	144	6
47777	1/2" Drive x 22mm Shallow Impact Socket	Plastic Hang Tab/Label	144	6
47778	1/2" Drive x 24mm Shallow Impact Socket	Plastic Hang Tab/Label	144	6
47779	1/2" Drive x 27mm Shallow Impact Socket	Plastic Hang Tab/Label	144	6
47780	1/2" Drive x 30mm Shallow Impact Socket	Plastic Hang Tab/Label	72	6
47781	1/2" Drive x 32mm Shallow Impact Socket	Plastic Hang Tab/Label	72	6
47785	1/2" Drive x 7/16" Deep Impact Socket	Plastic Hang Tab/Label	144	6
47786	1/2" Drive x 1/2" Deep Impact Socket	Plastic Hang Tab/Label	144	6
47787	1/2" Drive x 9/16" Deep Impact Socket	Plastic Hang Tab/Label	144	6
47788	1/2" Drive x 5/8" Deep Impact Socket	Plastic Hang Tab/Label	144	6
47789	1/2" Drive x 11/16" Deep Impact Socket	Plastic Hang Tab/Label	144	6
47790	1/2" Drive x 3/4" Deep Impact Socket	Plastic Hang Tab/Label	144	6
47791	1/2" Drive x 13/16" Deep Impact Socket	Plastic Hang Tab/Label	144	6
4929	3/8" Drive x 7/8" Oxygen Sensor Socket	Plastic Hang Tab/Label	100	10
47792	1/2" Drive x 7/8" Deep Impact Socket	Plastic Hang Tab/Label	72	6
47793	1/2" Drive x 15/16" Deep Impact Socket	Plastic Hang Tab/Label	72	6
47794	1/2" Drive x 1" Deep Impact Socket	Plastic Hang Tab/Label	72	6
47795	1/2" Drive x 1-1/16" Deep Impact Socket	Plastic Hang Tab/Label	72	6
47796	1/2" Drive x 1-1/8" Deep Impact Socket	Plastic Hang Tab/Label	72	6
47797	1/2" Drive x 1-1/4" Deep Impact Socket	Plastic Hang Tab/Label	48	6
47801	1/2" Drive x 10mm Deep Impact Socket	Plastic Hang Tab/Label	144	6
47802	1/2" Drive x 11mm Deep Impact Socket	Plastic Hang Tab/Label	144	6
47803	1/2" Drive x 12mm Deep Impact Socket	Plastic Hang Tab/Label	144	6
47804	1/2" Drive x 13mm Deep Impact Socket	Plastic Hang Tab/Label	144	6
47805	1/2" Drive x 14mm Deep Impact Socket	Plastic Hang Tab/Label	144	6
47806	1/2" Drive x 15mm Deep Impact Socket	Plastic Hang Tab/Label	144	6
47807	1/2" Drive x 16mm Deep Impact Socket	Plastic Hang Tab/Label	144	6
47808	1/2" Drive x 17mm Deep Impact Socket	Plastic Hang Tab/Label	144	6
47809	1/2" Drive x 18mm Deep Impact Socket	Plastic Hang Tab/Label	144	6
47810	1/2" Drive x 19mm Deep Impact Socket	Plastic Hang Tab/Label	144	6
47812	1/2" Drive x 21mm Deep Impact Socket	Plastic Hang Tab/Label	144	6
47813	1/2" Drive x 22mm Deep Impact Socket	Plastic Hang Tab/Label	72	6
47814	1/2" Drive x 24mm Deep Impact Socket	Plastic Hang Tab/Label	72	6
47815	1/2" Drive x 27mm Deep Impact Socket	Plastic Hang Tab/Label	72	6
4942	1/2" Drive x 29mm Heavy Duty FWD Impact Socket	Plastic Hang Tab/Label	40	5
4930	1/2" Drive x 30mm Heavy Duty FWD Impact Socket	Plastic Hang Tab/Label	48	8
4932	1/2" Drive x 32mm Heavy Duty FWD Impact Socket	Plastic Hang Tab/Label	30	6
4943	1/2" Drive x 33mm Deep Impact Socket	Plastic Hang Tab/Label	40	5
4933	3/4" Drive x 33mm Truck Lug Impact Socket	Plastic Hang Tab/Label	30	6
4934	1/2" Drive x 34mm Heavy Duty FWD Impact Socket	Plastic Hang Tab/Label	30	6
4935	1/2" Drive x 35mm Heavy Duty FWD Impact Socket	Plastic Hang Tab/Label	30	6
4936	1/2" Drive x 36mm Heavy Duty FWD Impact Socket	Plastic Hang Tab/Label	30	6
4938	1/2" Drive x 38mm Heavy Duty FWD Impact Socket	Plastic Hang Tab/Label	24	6
47820	1/2" Drive (F) x 3/8" (M) Impact Reducer	Plastic Hang Tab/Label	72	6
47821	1/2" Drive (M) x 3/8" (F) Impact Adapter	Plastic Hang Tab/Label	72	6
47822	1/2" Drive (F) x 3/4" (M) Impact Adapter	Plastic Hang Tab/Label	72	6
47823	3/4" Drive (F) x 1/2" (M) Impact Reducer	Plastic Hang Tab/Label	72	6
47824	1/2" Drive Impact Universal Joint	Plastic Hang Tab/Label	72	6
47825	1/2" Drive x 3" Impact Extension Bar	Plastic Hang Tab/Label	72	6
47826	1/2" Drive x 5" Impact Extension	Plastic Hang Tab/Label	72	6
47827	1/2" Drive x 10" Impact Extension	Plastic Hang Tab/Label	72	6



Adapters and Reducers

Universal Joints



Extensions



SAE

METRIC



COLOR-CODED TABS

**CARBON
STEEL**

1/4" Drive Deep Impact Socket Sets

- Drop Forged, Heat Treated Carbon Steel
 - Corrosion-Resistant Black Oxide Finish
 - 6-Point, Beveled-Nose Sockets
 - Hole on Socket Locks onto Drive Tang
 - Meets or Exceeds ANSI Standards
- Opti-Drive™ Socket Design Contacts Only Flat Surfaces of Fastener Head to Eliminate Rounding Off Corners

4825

- 8-pc. 1/4" Dr. Sockets (SAE): 3/16, 7/32, 1/4, 9/32, 5/16, 11/32, 3/8, 7/16"
- 1-pc. Storage Case

4830

- 8-pc. 1/4" Dr. Sockets (Metric): 5.5, 6, 7, 8, 9, 10, 11, 12mm
- 1-pc. Storage Case

Item	Description	Packaging	Cs	In
4825	8-pc. 1/4" Drive Deep Impact Socket Set (3/16"-7/16") Carbon Steel	Color Box	36	1
4830	8-pc. 1/4" Drive Deep Impact Socket Set (5.5-12mm) Carbon Steel	Color Box	36	1

**CHROME
VANADIUM**

3/8" Drive Shallow Impact Socket Sets

- Drop Forged, Heat Treated Chrome Vanadium Steel
 - Corrosion-Resistant Black Phosphate Finish
 - 6-Point, Beveled-Nose Sockets
 - Hole on Socket Locks onto Drive Tang
 - Meets or Exceeds ANSI Standards
- Opti-Drive™ Socket Design Contacts Only Flat Surfaces of Fastener Head to Eliminate Rounding Off Corners

4790

- 8-pc. 3/8" Dr. Sockets (SAE): 5/16", 3/8", 7/16", 1/2", 9/16", 5/8", 11/16", 3/4"
- 1-pc. Storage Case

4795

- 8-pc. 3/8" Dr. Sockets (Metric) 10, 11, 12, 13, 15, 17, 18, 19mm
- 1-pc. Storage Case

Item	Description	Packaging	Cs	In
4790	8-pc. 3/8" Drive Shallow Impact Socket Set (5/16"-3/4") Cr-V	Color Box	30	1
4795	8-pc. 3/8" Drive Shallow Impact Socket Set (10-19mm) Cr-V	Color Box	30	1

**CARBON
STEEL**

3/8" Drive Deep Impact Socket Sets

- Drop Forged, Heat Treated Carbon Steel
 - Corrosion-Resistant Black Oxide Finish
 - 6-Point, Beveled-Nose Sockets
 - Hole on Socket Locks onto Drive Tang
 - Meets or Exceeds ANSI Standards
- Opti-Drive™ Socket Design Contacts Only Flat Surfaces of Fastener Head to Eliminate Rounding Off Corners

4835

- 8-pc. 3/8" Dr. Sockets (SAE): 3/8, 7/16, 1/2, 9/16, 5/8, 11/16, 3/4, 13/16"
- 1-pc. Storage Case

4840

- 8-pc. 3/8" Dr. Sockets (Metric): 10, 11, 12, 13, 15, 17, 18, 19mm
- 1-pc. Storage Case

Item	Description	Packaging	Cs	In
4835	8-pc. 3/8" Drive Deep Impact Socket Set (3/8"-13/16") Carbon Steel	Color Box	20	1
4840	8-pc. 3/8" Drive Deep Impact Socket Set (10-19mm) Carbon Steel	Color Box	20	1

3/8" Drive Deep Impact Socket Sets

- Drop Forged, Heat Treated Chrome Vanadium Steel
 - Corrosion-Resistant Black Phosphate Finish
 - 6-Point, Beveled-Nose Sockets
 - Hole on Socket Locks onto Drive Tang
 - Meets or Exceeds ANSI Standards
- Opti-Drive™ Socket Design Contacts Only Flat Surfaces of Fastener Head to Eliminate Rounding Off Corners

4845

- 8-pc. 3/8" Dr. Sockets (SAE): 3/8, 7/16, 1/2, 9/16, 5/8, 11/16, 3/4, 13/16"
- 1-pc. Storage Case

4850

- 8-pc. 3/8" Dr. Sockets (Metric): 10, 11, 12, 13, 15, 17, 18, 19mm
- 1-pc. Storage Case

Item	Description	Packaging	Cs	In
4845	8-pc. 3/8" Drive Deep Impact Socket Set (3/8"-13/16") Cr-V	Color Box	20	1
4850	8-pc. 3/8" Drive Deep Impact Socket Set (10-19mm) Cr-V	Color Box	20	1



37-pc. 3/8", 1/2" Drive Impact Socket Set (3/8"-1-1/4")(11-32mm) Cr-V

- Drop Forged, Heat Treated Chrome Vanadium Steel
 - Corrosion-Resistant Black Electroplate Finish
 - 6-Point, Beveled-Nose Sockets
 - Hole on Socket Locks onto Drive Tang
 - Meets or Exceeds ANSI Standards
- Opti-Drive™ Socket Design Contacts Only Flat Surfaces of Fastener Head to Eliminate Rounding Off Corners

- 11-pc. Dual-Size Sockets Increase Range of Set by 32% Over Conventional Socket Sets
- 4 Sets in One

- 6-pc. 3/8" Dr. Shallow Impact Socket (SAE): 3/8", 7/16" (11mm), 1/2", 9/16", 11/16", 3/4" (19mm)
- 7-pc. 3/8" Dr. Shallow Impact Socket (MM): 8 (5/16"), 9, 12, 13, 14, 16 (5/8"), 17mm
- 11-pc. 1/2" Dr. Shallow Impact Socket (MM): 10, 11 (7/16"), 12, 13, 14, 15, 16 (5/8"), 17, 18, 21, 24mm (15/16")
- 10-pc. 1/2" Dr. Deep Impact Socket (SAE): 1/2", 9/16", 11/16", 3/4" (19mm), 13/16", 7/8" (22mm), 1", 1-1/16" (27mm), 1-1/8", 1-1/4" (32mm)
- 1-pc. 1/2" (F) x 3/8" (M) Adapter
- 1-pc. 3/8" Dr. x 3" Extension Bar
- 1-pc. 1/2" Dr. x 3" Extension Bar
- 1-pc. Storage Case

Item	Description	Packaging	Cs	In
4888	37-pc. 3/8", 1/2" Drive Impact Socket Set (3/8"-1-1/4")(11-32mm) Cr-V	Color Box	4	1



1/2" Drive Shallow Impact Socket Sets

- Drop Forged, Heat Treated Chrome Vanadium Steel
 - Corrosion-Resistant Black Phosphate Finish
 - 6-Point, Beveled-Nose Sockets
 - Hole on Socket Locks onto Drive Tang
 - Meets or Exceeds ANSI Standards
- Opti-Drive™ Socket Design Contacts Only Flat Surfaces of Fastener Head to Eliminate Rounding Off Corners

4810

- 10-pc. 1/2" Dr. Sockets (SAE): 7/16, 1/2, 9/16, 5/8, 11/16, 3/4, 13/16, 7/8, 15/16, 1"
- 1-pc. Storage Case

4815

- 10-pc. 1/2" Dr. Sockets (Metric): 11, 12, 13, 15, 17, 18, 19, 21, 22, 24mm
- 1-pc. Storage Case

Item	Description	Packaging	Cs	In
4810	10-pc. 1/2" Drive Shallow Impact Socket Set (7/16"-1") Cr-V	Color Box	20	1
4815	10-pc. 1/2" Drive Shallow Impact Socket Set (11-24mm) Cr-V	Color Box	20	1





1/2" Drive Shallow Impact Socket Sets

- Drop Forged, Heat Treated Chrome Vanadium Steel
- Corrosion-Resistant Black Phosphate Finish
- 6-Point, Beveled-Nose Sockets
- Hole on Socket Locks onto Drive Tang
- Meets or Exceeds ANSI Standards
- Opti-Drive™ Socket Design Contacts Only Flat Surfaces of Fastener Head to Eliminate Rounding Off Corners

4816

- 14-pc. 1/2" Dr. Sockets (SAE): 3/8, 7/16, 1/2, 9/16, 5/8, 11/16, 3/4, 13/16, 7/8, 15/16, 1, 1-1/16, 1-1/8, 1-1/4"
- 1-pc. Storage Case

4817

- 14-pc. 1/2" Dr. Sockets (Metric): 11, 12, 13, 14, 15, 17, 18, 19, 21, 22, 24, 27, 30, 32mm
- 1-pc. Storage Case

Item	Description	Packaging	Cs	In
4816	14-pc. 1/2" Drive Shallow Impact Socket Set (3/8"-1-1/4") Cr-V	Color Box	12	1
4817	14-pc. 1/2" Drive Shallow Impact Socket Set (11-32mm) Cr-V	Color Box	12	1



1/2" Drive Deep Impact Socket Sets

- Drop Forged, Heat Treated Carbon Steel
- Corrosion-Resistant Black Oxide Finish
- 6-Point, Beveled-Nose Sockets
- Hole on Socket Locks onto Drive Tang
- Meets or Exceeds ANSI Standards
- Opti-Drive™ Socket Design Contacts Only Flat Surfaces of Fastener Head to Eliminate Rounding Off Corners

4855

- 11-pc. 1/2" Dr. Sockets (SAE): 3/8, 7/16, 1/2, 9/16, 5/8, 11/16, 3/4, 13/16, 7/8, 15/16, 1"
- 1-pc. Storage Case

4860

- 11-pc. 1/2" Dr. Sockets (Metric): 10, 11, 12, 13, 15, 17, 18, 19, 21, 22, 24mm
- 1-pc. Storage Case

Item	Description	Packaging	Cs	In
4855	11-pc. 1/2" Drive Deep Impact Socket Set (3/8"-1") Carbon Steel	Color Box	10	1
4860	11-pc. 1/2" Drive Deep Impact Socket Set (10-24mm) Carbon Steel	Color Box	10	1



1/2" Drive Deep Impact Socket Sets

- Drop Forged, Heat Treated Chrome Vanadium Steel
- Corrosion-Resistant Black Phosphate Finish
- 6-Point, Beveled-Nose Sockets
- Hole on Socket Locks onto Drive Tang
- Meets or Exceeds ANSI Standards
- Opti-Drive™ Socket Design Contacts Only Flat Surfaces of Fastener Head to Eliminate Rounding Off Corners

4865

- 11-pc. 1/2" Dr. Sockets (SAE): 3/8, 7/16, 1/2, 9/16, 5/8, 11/16, 3/4, 13/16, 7/8, 15/16, 1"
- 1-pc. Storage Case

4870

- 11-pc. 1/2" Dr. Sockets (Metric): 10, 11, 12, 13, 15, 17, 18, 19, 21, 22, 24mm
- 1-pc. Storage Case

Item	Description	Packaging	Cs	In
4865	11-pc. 1/2" Drive Deep Impact Socket Set (3/8"-1") Cr-V	Color Box	10	1
4870	11-pc. 1/2" Drive Deep Impact Socket Set (10-24mm) Cr-V	Color Box	10	1

1/2" Drive Deep Impact Socket Sets

- Drop Forged, Heat Treated Carbon Steel
 - Corrosion-Resistant Black Oxide Finish
 - 6-Point, Beveled-Nose Sockets
 - Hole on Socket Locks onto Drive Tang
 - Meets or Exceeds ANSI Standards
- Opti-Drive™ Socket Design Contacts Only Flat Surfaces of Fastener Head to Eliminate Rounding Off Corners



- 4875**
- 14-pc. 1/2" Dr. Sockets (SAE): 3/8, 7/16, 1/2, 9/16, 5/8, 11/16, 3/4, 13/16, 7/8, 15/16, 1, 1-1/16, 1-1/8, 1-1/4"
 - 1-pc. Storage Case
- 4878**
- 14-pc. 1/2" Dr. Sockets (Metric): 11, 12, 13, 14, 15, 17, 18, 19, 21, 22, 24, 27, 30, 32mm
 - 1-pc. Storage Case

Item	Description	Packaging	Cs	In
4875	14-pc. 1/2" Drive Deep Impact Socket Set (3/8"-1-1/4") Carbon Steel	Color Box	6	1
4878	14-pc. 1/2" Drive Deep Impact Socket Set (11-32mm) Carbon Steel	Color Box	6	1

1/2" Drive Deep Impact Socket Sets

- Drop Forged, Heat Treated Chrome Vanadium Steel
 - Corrosion-Resistant Black Phosphate Finish
 - 6-Point, Beveled-Nose Sockets
 - Hole on Socket Locks onto Drive Tang
 - Meets or Exceeds ANSI Standards
- Opti-Drive™ Socket Design Contacts Only Flat Surfaces of Fastener Head to Eliminate Rounding Off Corners



- 4880**
- 14-pc. 1/2" Dr. Sockets (SAE): 3/8, 7/16, 1/2, 9/16, 5/8, 11/16, 3/4, 13/16, 7/8, 15/16, 1, 1-1/16, 1-1/8, 1-1/4"
 - 1-pc. Storage Case
- 4885**
- 14-pc. 1/2" Dr. Sockets (Metric): 11, 12, 13, 14, 15, 17, 18, 19, 21, 22, 24, 27, 30, 32mm
 - 1-pc. Storage Case

Item	Description	Packaging	Cs	In
4880	14-pc. 1/2" Drive Deep Impact Socket Set (3/8"-1-1/4") Cr-V	Color Box	6	1
4885	14-pc. 1/2" Drive Deep Impact Socket Set (11-32mm) Cr-V	Color Box	6	1

1/2" Drive Deep Jumbo Impact Socket Set (1-3/16"-1-1/2")

- Drop Forged, Heat Treated Chrome Molybdenum Steel
 - Corrosion-Resistant Black Phosphate Finish
 - 6-Point, Beveled-Nose Sockets
 - Hole on Socket Locks onto Drive Tang
 - Meets or Exceeds ANSI Standards
- Opti-Drive™ Socket Design Contacts Only Flat Surfaces of Fastener Head to Eliminate Rounding Off Corners
- 5-pc. 1/2" Drive Impact Sockets (SAE): 1-3/16", 1-5/16", 1-3/8", 1-7/16", 1-1/2"
 - Complete with Storage Case



Item	Description	Packaging	Cs	In
4886	1/2" Drive Deep Jumbo Impact Socket Set (1-3/16"-1-1/2")	White Box/Color Label	6	1



CHROME VANADIUM

3/4" Drive Deep Impact Socket Sets

- Drop Forged, Heat Treated Chrome Vanadium Steel
- Corrosion-Resistant Black Phosphate Finish
- 6-Point Beveled-Nose Sockets
- Hole on Socket Locks onto Drive Tang
- Meets or Exceeds ANSI Standards
- Opti-Drive™ Socket Design Contacts Only Flat Surfaces of Fastener Head to Eliminate Rounding Off Corners

4889

- 8-pc. 3/4" Drive Impact Sockets (Metric): 27, 29, 30, 32, 33, 34, 36, 38mm
- 1-pc. Storage Case

4891

- 8-pc. 3/4" Dr. Socket (SAE): 1", 1-1/16, 1-1/8, 1-1/4, 1-5/16, 1-3/8, 1-7/16, 1-1/2"
- 1-pc. Storage Case

Item	Description	Packaging	Cs	In
4889	8-pc. 3/4" Drive Deep Impact Socket Set (27-38mm) Cr-V	Color Box	5	1
4891	8-pc. 3/4" Drive Deep Impact Socket Set (1"-1-1/2") Cr-V	Color Box	5	1



CHROME VANADIUM

CHROME MOLY

7-pc. 3/4" Drive Deep Impact Socket Set (15/16"-1-1/2") Cr-V, Cr-Mo

- Drop Forged, Heat Treated Chrome Molybdenum and Chrome Vanadium Steel
- Corrosion-Resistant Black Phosphate Finish
- 6-Point, Beveled-Nose Sockets
- Hole on Socket Locks onto Drive Tang
- Meets or Exceeds ANSI Standards

- Opti-Drive™ Socket Design Contacts Only Flat Surfaces of Fastener Head to Eliminate Rounding Off Corners

- 6-pc. 3/4" Dr. Sockets Sizes (SAE): 15/16, 1", 1-1/16, 1-1/8, 1-1/4, 1-1/2"
- 1-pc. 3/4" Dr. x 13/16" Square Lug Socket
- 1-pc. Storage Case

Item	Description	Packaging	Cs	In
4890	7-pc. 3/4" Drive Deep Impact Socket Set (15/16"-1-1/2") Cr-V, Cr-Mo	Color Box	5	1



CHROME MOLY

3/4" Drive Shallow Impact Socket Set (2-1/16"-2-1/2") Cr-Mo

- Professional-Grade, Forged and Hardened Chrome Molybdenum Steel Construction
- Corrosion-Resistant Black Phosphate Finish
- 6-Point Beveled-Nose Sockets
- Hole on Socket Locks onto Drive Tang
- Large, Easy-to-Read, Laser-Etched Markings for Quick Size Selection
- Meets or Exceeds ANSI Standards

- Opti-Drive™ Socket Design Contacts Only Flat Surfaces of Fastener Head to Eliminate Rounding Off Corners

- 8-pc. 3/4" Drive Impact Sockets (SAE): 2-1/16, 2-1/8, 2-3/16, 2-1/4, 2-5/16, 2-3/8, 2-7/16, 2-1/2"
- Complete with Heavy Duty Carrying Case

Item	Description	Packaging	Cs	In
4893	3/4" Drive Shallow Impact Socket Set (2-1/16"-2-1/2") Cr-Mo	Color Sleeve	2	1

21-pc. 3/4" Drive Impact Socket Set (SAE)

- Professional-Grade, Forged and Hardened Chrome Vanadium Steel Construction
- Corrosion-Resistant Black Phosphate Finish
- Beveled-End, 6-Point Impact Sockets
- 24-Tooth, Quick-Release, Lock-On Ratchet with Non-Slip, Knurled Handle Grip
- Meets or Exceeds ANSI Standards
- Opti-Drive™ Socket Design Contacts Only Flat Surfaces of Fastener Head to Eliminate Rounding Off Corners
- 1-pc. 3/4" Drive 19" Ratchet Handle
- 1-pc. 3/4" Drive 18" Sliding T-Head Breaker Bar
- 2-pc. 3/4" Drive Extensions: 4" and 8"
- 16-pc. 3/4" Drive Impact Sockets: 3/4", 7/8", 15/16", 1", 1-1/16", 1-1/8", 1-3/8", 1-1/4", 1-5/16", 1-3/8", 1-7/16", 1-1/2", 1-5/8", 1-3/4", 1-7/8", 2"
- 1-pc. Carry Case

Item	Description	Packaging	Cs	In
4899	21-pc. 3/4" Drive Impact Socket Set (SAE)	Color Sleeve	1	1



9-pc. 1" Drive Deep Impact Socket Set (1"-2") Cr-V, Cr-Mo

- Drop Forged, Heat Treated Chrome Molybdenum and Chrome Vanadium Steel
- Corrosion-Resistant Black Phosphate Finish
- 6-Point, Beveled-Nose Sockets
- Hole on Socket Locks onto Drive Tang
- Meets or Exceeds ANSI Standards
- Opti-Drive™ Socket Design Contacts Only Flat Surfaces of Fastener Head to Eliminate Rounding Off Corners
- 9-pc. 1" Dr. Impact Sockets (SAE): (CrMo) 1", 1-1/8, 1-1/4, 1-3/8, 1-1/2, 1-5/8, (CrV) 1-3/4, 1-7/8, 2"
- 1-pc. Metal Storage/Carry Case

Item	Description	Packaging	Cs	In
4892	9-pc. 1" Drive Deep Impact Socket Set (1"-2") Cr-V, Cr-Mo	White Box/Color Label	2	1





7-pc. 3/8" Drive Brake Caliper Impact Bit Set (SD40-60, 1/4"-3/8") Cr-V

- Drop Forged, Heat Treated Chrome Vanadium Steel
- Corrosion-Resistant Black Oxide Finish
- Precision-Machined Tip for Exact Fit
- Locks onto Drive Tang
- Common Sizes for Disc Brake Calipers
- 4-pc. 3/8" Dr. Star Sizes: SD-40, SD-45, SD-50, SD-60
- 3-pc. 3/8" Dr. Hex Sizes (SAE): 1/4", 5/16", 3/8"
- 1-pc. Organizer Rail

Item	Description	Packaging	Cs	In
4908	7-pc. 3/8" Drive Brake Caliper Impact Bit Set (SD40-60, 1/4"-3/8") Cr-V	Slide Blister Card	48	6



3/8" Drive Impact Star Bit Socket Set (SD40-60) Cr-V

- Drop Forged, Heat Treated Chrome Vanadium Steel
- Corrosion-Resistant Black Oxide Finish
- Precision-Machined Tip for Exact Fit
- Locks onto Drive Tang
- 6-pc. 3/8" Dr. Star Sizes: SD-40, SD-45, SD-47, SD-50, SD-55, SD-60
- Complete with Organizer Rail

Item	Description	Packaging	Cs	In
4911	3/8" Drive Impact Star Bit Socket Set (SD40-60) Cr-V	Slide Blister Card	48	6



13-pc. 1/4" and 3/8" Drive Impact Star Bit Set (SD10-60) Cr-V

- Drop Forged, Heat Treated Chrome Vanadium Steel
- Corrosion-Resistant Black Oxide Finish
- Precision-Machined Tip for Exact Fit
- Locks onto Drive Tang
- 6-pc. 1/4" Dr. Star Sizes: SD-10, SD-15, SD-20, SD-25, SD-27, SD-30
- 6-pc. 3/8" Dr. Star Sizes: SD-40, SD-45, SD-47, SD-50, SD-55, SD-60
- 1-pc. 3/8" Dr. (F) x 1/4" Dr. (M) Adapter
- 2-pc. Organizer Rails

Item	Description	Packaging	Cs	In
4912	13-pc. 1/4" and 3/8" Drive Impact Star Bit Set (SD10-60) Cr-V	Slide Blister Card	36	6



13-pc. 1/4" and 3/8" Drive Tamper Star Bit Set (SD10-60) Cr-V

- Drop Forged, Heat Treated Chrome Vanadium Steel
- Corrosion-Resistant Black Oxide Finish
- Precision-Machined Tip for Exact Fit
- Locks onto Drive Tang
- 6-pc. 1/4" Dr. Star Sizes: SD-10, SD-15, SD-20, SD-25, SD-27, SD-30
- 6-pc. 3/8" Dr. Star Sizes: SD-40, SD-45, SD-47, SD-50, SD-55, SD-60
- 1-pc. 3/8" Dr. (F) x 1/4" Dr. (M) Adapter
- 2-pc. Organizer Rails

Item	Description	Packaging	Cs	In
4916	13-pc. 1/4" and 3/8" Drive Tamper Star Bit Set (SD10-60) Cr-V	Slide Blister Card	36	6

3-pc. Impact Extension Bar Sets

4965 / 4970

- Forged and Hardened Carbon Steel
- Corrosion-Resistant Black Oxide Finish
- Locks onto Drive Tang
- Spring-Loaded Ball Bearing Socket Retainer



4965 / 4966

- 1-pc. 3/8" Dr. x 3" Extension Bar
- 1-pc. 3/8" Dr. x 6" Extension Bar
- 1-pc. 3/8" Dr. x 8" Extension Bar

4966 / 4971

- Forged and Hardened Chrome Vanadium Steel
- Corrosion-Resistant Black Oxide Finish
- Locks onto Drive Tang
- Spring-Loaded Ball Bearing Socket Retainer



4970 / 4971

- 1-pc. 1/2" Dr x 3" Extension Bar
- 1-pc. 1/2" Dr x 6" Extension Bar
- 1-pc. 1/2" Dr x 8" Extension Bar



Item	Description	Packaging	Cs	In
4965	3-pc. 3/8" Drive Impact Extension Bar Set - Carbon Steel	Plastic Hang Tab/Label	30	6
4966	3-pc. 3/8" Drive Impact Extension Bar Set - Cr-V	Plastic Hang Tab/Label	30	6
4970	3-pc. 1/2" Drive Impact Extension Bar Set - Carbon Steel	Plastic Hang Tab/Label	30	6
4971	3-pc. 1/2" Drive Impact Extension Bar Set - Cr-V	Plastic Hang Tab/Label	30	6

3-pc. Impact Reducer Sets

4955

- Drop Forged, Heat Treated Carbon Steel
- Corrosion-Resistant Black Oxide Finish
- Locks onto Socket and Drive Tang

CARBON STEEL

4955 / 4956

- 1-pc. 3/8" (F) x 1/4" (M)
- 1-pc. 1/2" (F) x 3/8" (M)
- 1-pc. 3/4" (F) x 1/2" (M)

4956

- Drop Forged, Heat Treated Chrome Vanadium Steel
- Corrosion-Resistant Black Oxide Finish
- Locks onto Socket and Drive Tang

CHROME VANADIUM

Item	Description	Packaging	Cs	In
4955	3-pc. Impact Reducer Set - Carbon Steel	Slide Blister Card	96	12
4956	3-pc. Impact Reducer Set - Cr-V	Slide Blister Card	72	12



4-pc. Impact Adapter and Reducer Sets

4957

- Drop Forged, Heat Treated Chrome Vanadium Steel
- Corrosion-Resistant Black Oxide Finish
- Locks onto Socket and Drive Tang

CHROME VANADIUM

4957 / 4958

- 2-pc. Reducers: 1/2" (F) x 3/8" (M), 3/8" (F) x 1/4" (M)
- 2-pc. Adapters: 3/8" (F) x 1/2" (M), 1/4" (F) x 3/8" (M)

4958

- Drop Forged, Heat Treated Carbon Steel
- Corrosion-Resistant Black Oxide Finish
- Locks onto Socket and Drive Tang

CARBON STEEL

Item	Description	Packaging	Cs	In
4957	4-pc. Impact Adapter and Reducer Set - Cr-V	Slide Blister Card	96	12
4958	4-pc. Impact Adapter and Reducer Set - Carbon Steel	Slide Blister Card	72	12



3-pc. Impact Adapter Sets

4959

- Drop Forged, Heat Treated Chrome Vanadium Steel
- Corrosion-Resistant Black Oxide Finish
- Locks onto Socket and Drive Tang

CHROME VANADIUM

4959 / 4960

- 1-pc. 1/4" (F) x 3/8" (M)
- 1-pc. 3/8" (F) x 1/2" (M)
- 1-pc. 1/2" (F) x 3/4" (M)

4960

- Drop Forged, Heat Treated Carbon Steel
- Corrosion-Resistant Black Oxide Finish
- Locks onto Socket and Drive Tang

CARBON STEEL

Item	Description	Packaging	Cs	In
4959	3-pc. Impact Adapter Set - Cr-V	Slide Blister Card	96	12
4960	3-pc. Impact Adapter Set - Carbon Steel	Slide Blister Card	96	12



3-pc. Impact Universal Joint Sets

4963

- Drop Forged, Heat Treated Carbon Steel
- Corrosion-Resistant Black Oxide Finish
- Locks onto Socket and Drive Tang

CARBON STEEL

4963 / 4964

- 1-pc. 1/4" Drive
- 1-pc. 3/8" Drive
- 1-pc. 1/2" Drive

4964

- Drop Forged, Heat Treated Chrome Vanadium Steel
- Corrosion-Resistant Black Phosphate Finish
- Locks onto Socket and Drive Tang

CHROME VANADIUM

Item	Description	Packaging	Cs	In
4963	3-pc. Impact Universal Joint Set - Carbon Steel	Slide Blister Card	120	12
4964	3-pc. Impact Universal Joint Set - Cr-V	Slide Blister Card	120	12



Individual Programs

Combination wrenches	25
Files	79
Hex bit sockets	12
Impact sockets	157
Chisels and punches	84

Power bits	49
Putty and taping knives	97
Screwdrivers	39
Sockets and accessories	10-11
Wood chisels	85

Alphabetical Index

A	
Abrasives	112-114
Adapters and reducers	10-11, 18, 157, 165
Adjustable wrenches	26-27
Air control units	155
Air die grinders	149
Air drills	148
Air hammers	148
Air hose reels	156
Air hoses	156
Air pumps	133
Air ratchets	147
Air regulators	155
Air tools	146-156
Aluminum pipe wrenches	27
Angle open end wrenches	22
Angle vises	75
Auto body repair tools	122-123
Auto-load snap off knives	92
Automotive lockout tool	122
Automotive spray guns	151
Automotive tire plug repair kit	133
Automotive tools	122-133
Aviation snips	66
Axes	55
B	
Ball pein hammers	52
Bar clamps	73
Basin wrenches	33
Battery service tools	127
Battery testers	69
Bearing seperators	125
Bench grinder accessories	112-113
Bench vises	75
Benders	77
Bike hooks	120
Bit socket sets	12-13, 164
Bolt cutters	66
Bottle jacks	134
Bow saws	88
Box cutters	91-92
Brake tools	128
Breaker bars	16
Bungee cords	143
C	
Cable ties	70

Calipers	102
Camping and outdoor tools	55, 87-88
Cargo securing products	140-143
Caulking guns	98
C-Clamps	74
Center punches	80-81, 84
Chipping hammers	55
Chisels	83-85
Circuit testers	69, 127
Clamps	71-74
Claw hammers	50-51
Clean-up tools	111
Click torque wrenches	28-29
Cold chisels	83-84
Combination wrench sets	20-24
Come-alongs	135
Coping saws	86, 88
Countersinks	80
Couplers	153
Craft and hobby accessories	70
Crimping tools & terminals	67
Crowfoot wrenches	29
Cut-off tools	149
Cutting pliers	58, 61-63
D	
Dead blow hammers	54
Dent pullers	122-123
Diagonal cutting pliers	58, 61-63
Dial indicator	102
Die grinders	149
Double duty tarps	145
Drill bits	104-105
Drill bits and accessories	45, 104-105
Drill press vises	75
Drilling hammers	53
Drills	148
Drywall saws	88
Dust masks	99
Dust pans	111
E	
Ear muffs	99
Electrical tape	68
Electrical testers	69, 127
Electrical tools	67-70
Emergency tire plug repair kit	133
End nippers	58

Extension bars	10-11, 17, 157, 164
Eye goggles	99
F	
Fencing pliers	59, 61
Files	78-79
Finger ratchet	15
Flashlights	118-119
Flare nut wrenches	33
Flaring tools	77
Flex grip pliers	62
Folding utility knives	93, 115-116
Framing hammers	52
Framing squares	100
Funnels	129
Furniture dolly	111
G	
Garage jacks	134
Gear pullers	122, 124-126
Glass cutters	95
Gluing clamps	73
Goggles	99
Grinding stones	113
Grommets and grommet tools	145
Groove joint pliers	58, 60
H	
Hacksaw blades	89
Hacksaws	86-89
Hammers	50-55
Hardware	120-121
Hatchets	55
Hearing protection	99
Helping hand with magnifier	70
Hex key wrenches	30-32
High speed sanders	150
Hitch balls and couplers	136
Hitch receiver pins	137
Hobby	70
Hoists	135
Hollow punches	82
Hooks	120
Hoses	156
Hose reels	156
Hydraulic jacks	134
I	
Impact socket accessories	157, 164-165
Impact socket adapters	157, 165
Impact sockets	157-165
Impact socket reducers	157, 165
Impact socket sets	158-164
Impact wrenches	146-147
Inspection tools	108-110
J	
Jacks	134, 138
Jigsaw blades	90

Jumbo combination wrenches	22-23, 25
Jumbo ratchet/socket sets	5-7, 14
K	
Knee pads	99
Knives	91-97
L	
Layout tools	100-101
LED lights	118-119
Leather punches	81
Letter and number punches	81
Levels	101
Line wrenches	33
Linesman	59, 61-63
Load binders	140
Locking clamps	73
Locking pliers	63-64
Lockout tools	122
Long nose pliers	58, 60, 62-63
Long reach pliers	62
Lug wrenches	133
M	
Machinist hammers	53
Magnetic base for dial indicator	102
Magnetic pick-up tools	108-111
Magnetic welding holders	74
Mallets	53-54
Measuring tools	100-103
Micrometer	102
Mover's dolly	111
Multi-testers	69
Multi-tools	95
N	
Nail sets	80
Number and letter punches	81
Nut drivers	15, 48
Nut splitter	107
O	
"O"-rings	120
Offset box ratchet wrenches	24
Offset screwdrivers	37
Oil filter wrenches	129
P	
Padlocks	121
Paint brushes	98
Paint spray guns	151
Painting and finishing	97-98
Palm ratchet	15
Parts cleaning brush	130
Parts trays	19, 109
Personal safety	99
Pick and hook sets	131
Pick-up tools	108-111
Pipe cutters	76

Pipe snake	77
Pipe threaders	107
Pipe wrenches	27
Pliers	58-66
Pneumatic accessories	152-155
Pneumatic tools	146-152
Power driver bit sets	45-48
Power nut drivers	48
Power pullers	135
Precision measuring tools	102
Precision pliers	63
Precision screwdrivers	40, 43
Protective equipment	99
Pry bars	56-57
Punches	80-84
Putty knives	97
R	
Ratchet bar clamps	73
Ratchet and socket sets	2-6
Ratchet tie downs	140-141
Ratcheting combination wrenches	24
Ratchets	14-15
Receiver pins	137
Reciprocating saw blades	90
Recovery straps	139
Reducers and adapters	10-11, 18, 157, 165
Respiratory protection	99
Retractable air hose reels	156
Rip hammers	50-51
Rivet guns	106
Rubber mallets	53-54
Rubber tie downs	142
S	
Sabre saws	90
Safety equipment	99
Safety glasses	99
Safety scrapers	96
Safety tape	99
Sandblasters	152
Sanders	150
Saw blades	89-90
Saws	86-90
Scissors	96
Screwdriver bit sets	41-48
Screwdriver sets	34-38, 40
Screwdrivers	34-49
Screw extractors	107
Sharpening stones	113
Shingle hatchets	55
Shovels	55
Sledge hammers	53
Slide hammer pullers	122
Slip joint pliers	58, 60
Snap-off knives	91-92
Snap ring pliers	65
Snips	66
Socket holders	19

Socket sets	2-9, 12-13
Soft mallets	53-54
Soldering irons	68
Spark plug tools	127
Spray guns	151
Spring clamps	72-73
Squares	100
Standard duty tarps	144
Storage hooks	120
Stubby combination wrenches	20-21
Suction cup dent pullers	123
T	
Tack hammers	50
Tack pullers	39, 56
Tap and die sets	106-107
Tape	68, 99, 156
Tape measures	101, 103
Tarp repair	145
Tarps	144-145
Thread sealing tape	156
Tie downs	140-143
Tin snips	66
Tire gauges	132-133
Tire pumps	133
Tire repair tools	133
Tire service tools	132-133
Tool sets	115-117
Tool storage	19, 121
Torque wrenches	28-29
Towing	136-139
Tow ropes and straps	139
Trailer jacks	138
Tubing benders	77
Tubing cutters	76
Tweezers	70
U	
Universal joints	10-11, 18, 165
Utility hooks	120
Utility knife blades	94
Utility knives and scrapers	91-96
V	
Vises	75
W	
Wallboard saw	88
Welding accessories	55, 71, 74
Welding clamps	71
Winches	135, 138
Wire brushes	112-114
Wire strippers	67
Wire wheels	112
Wobble extension bars	17
Wood chisels	85
Wrecking bars	56
Wrench holders	33
Wrenches	20-33



Get more from Michigan Industrial Tools

www.mit-tool.com

MIT home page

Corporate and product brand overview



Order online



Member Portal

Sign in to your secure member portal with your own password and you can:

- Maintain your account information
- Contact your sales representative
- Review current and past invoices
- **Order products**
- Find the latest special offers and promotions
- Get marketing support materials including catalogs, logos, product photos and more

TEKTON® home page

- Get more info about TEKTON®
- Download product catalogs



TEKTON® product line

- Overview of complete product line with simple, organized menus and quick-search feature

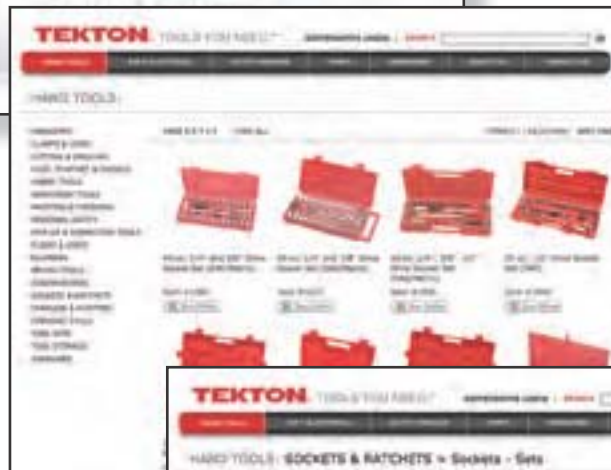

TEKTON® product detail

- Complete product information and specifications



40 YEARS STRONG



**MICHIGAN
INDUSTRIAL
TOOLS**

®

For more than 40 years, Michigan Industrial Tools has been a leading hand tool company, supplying major retail chains, automotive centers, and independent hardware, lumber, and farm supply stores. Our comprehensive product line contains over 2000 different SKUs for the consumer, professional, and automotive markets.

Experience.
Quality processes.
Innovative products.
And personal service.



- Stays flexible even in cold weather
- Working temperature range -40° to 190°
- 10 year guarantee

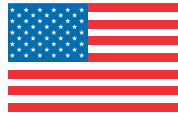

**HOSE
100%
USA MADE**



RUBBER AIR HOSE



- Professional grade all-steel construction
- Heavy duty dual arm with 4-roller hose guide

**AUTO-RETRACTING
AIR HOSE REELS**



GOODYEAR

Michigan Industrial Tools is a proud supplier of Goodyear air hoses and the only authorized source for Goodyear air hose reels.

**GOODYEAR PERFORMANCE.
READY FOR RETAIL.**

NEARLY
100 SKUs



MAXCRAFT®

MAXCRAFT is our premium line of innovative tools and lighting products full of features you may not have expected, but will never again want to do without.

You can't just walk by MAXCRAFT. Its powerful presence pulls you in. With this many unique tools in one place, you won't want to leave.

www.getmaxcraft.com

REV IT UP™



WorkShop®

WorkShop stands apart.

An innovation in impulse table merchandising, WorkShop offers value *and* style, attracting both bargain and brand-conscious shoppers.

www.getworkshop.com

OVER
280 SKUs



• AVAILABLE IN DISPLAY QUANTITIES ONLY

- 1831 3-pc. Project Tool Set (Tape, Hammer, Screwdriver)
- 1832 3-pc. Project Tool Set (Tape, Knife, Screwdriver)
- 1833 3-pc. Project Tool Set (Tape, Hammer, Knife)

PG. 115

- 1834 2-pc. LED Light, Utility Knife W/ Bonus Keychain LED
- 1835 2-pc. Multi-Tool and Knife Set
- 1836 3-pc. LED Light, Sport Utility Knife and Multi-Tool Set

PG. 116

- 7476 2-pc. Compact LED Worklight Set
- 7477 2-pc. LED Flashlight / Worklight Set
- 7478 2-pc. LED Flashlight Set with Bonus Keychain Flashlight

PG. 118

PG. 117



PG. 117



PG. 117



2845 36-pc. Precision Screwdriver Set

2832 52-pc. Ratchet Screwdriver Set

2843 22-pc. Stubby Ratchet Screwdriver Set



7480 3-pc. LED Flashlight Set PG. 118



8054 4-pc. Scissors and Snap-Off Knife Set PG. 96



2769 54-pc. Screwdriver Set PG. 36

• AVAILABLE IN DISPLAY QUANTITIES ONLY



Item	Description	Packaging	Cs	In
1831	3-pc. Project Tool Set	Sealed Blister/Display Box	24	6
1832	3-pc. Project Tool Set	Sealed Blister/Display Box	24	6
1833	3-pc. Project Tool Set	Sealed Blister/Display Box	24	6
1834	2-pc. LED Light, Utility Knife W/ Bonus Keychain LED	Sealed Blister/Display Box	24	6
1835	2-pc. Multi-Tool and Knife Set	Sealed Blister/Display Box	32	8
1836	3-pc. LED Light, Sport Utility Knife and Multi-Tool Set	Sealed Blister/Display Box	24	6
7476	2-pc. Compact LED Worklight Set	Sealed Blister/Display Box	48	6
7477	2-pc. LED Flashlight / Worklight Set	Sealed Blister/Display Box	48	6
7478	2-pc. LED Flashlight Set with Bonus Keychain Flashlight	Sealed Blister/Display Box	48	6
2845	36-pc. Precision Screwdriver Set	Color Label/Display Box	24	6
2843	22-pc. Stubby Ratchet Screwdriver Set	Color Label/Display Box	40	10
2832	52-pc. Ratchet Screwdriver Set	Color Label/Display Box	24	6
7480	3-pc. LED Flashlight Set	Sealed Blister/Display Box	24	6
8054	4-pc. Scissors and Snap-Off Knife Set	Sealed Blister/Display Box	24	6
2769	54-pc. Screwdriver Set	Sealed Blister/Display Box	12	6

TEKTON® Tool Box

8518 TEKTON Floor Standing Cardboard Merchandiser



4 ft. Endcap Planogram



Individual Tool Programs

For full program and product details, check out these and our other individual programs throughout the catalog. See page 166 for complete listing of programs and pages.

SOCKETS PG. 10-11

201 SKUs





24
SKUs



51 SKUs

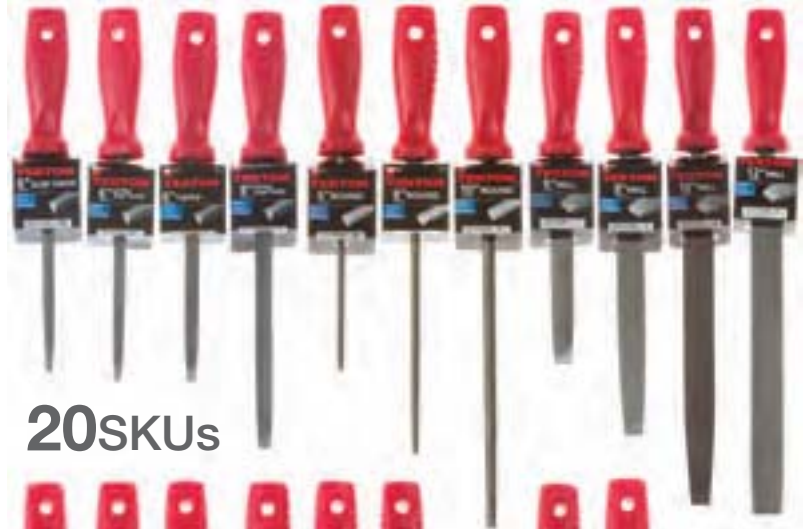

20 SKUs



FILES
PG. 79

TAKE IT ON.
TEKTON[®]



Michigan Industrial Tools
3707 Roger B. Chaffee Drive SE
Grand Rapids, MI 49548

Phone: (616) 243-2443 • Toll-Free: (888) 648-8665 • Fax: (616) 243-6648
E-mail: info@mit-tool.com • www.mit-tool.com

www.tektontools.com

TAKE IT ON.